



Marine Owner's Manual

FOR THE TURBOCHEF SINGLE BATCH RAPID COOK OVEN



For further information, call
800-908-8726

Original Instructions

The information contained in this manual is important for the proper installation, use, maintenance, and repair of this oven. Follow these procedures and instructions to help ensure satisfactory baking results and years of trouble-free service.

Errors – descriptive, typographic, or pictorial – are subject to correction. Specifications are subject to change without notice.

Please carefully read this manual and retain it for future reference.

Table of Contents

Important Safety Instructions

General Safety Information	i
Reducing Fire Risk	i
Grounding Instructions	ii
Power Cord Replacement or Removal	ii
Protective Earth (Ground) Symbol	ii
Equipotential Bonding Symbol	ii

Specifications and Installation

Theory of Operation	1
Features	1
Dimensions	1
Certifications	2
Oven Construction	2
Electrical Specifications	2
Installation	2
Unpacking Instructions	2
Installation Warnings - Read Before Lifting Oven	2
Lifting and Placing the Oven	3
Installation Near Open Heat Source	3
Oven Restraint Kit	4
TurboChef Connect™	4
ChefComm Pro®	4
Date and Time Prompt	4
Voltage Selection	4
Ventilation	4

Oven Maintenance

Daily Maintenance	5
Weekly Maintenance	7

Oven Controls

9

Cooking

Menu Cook Mode	10
Manual Cook Mode	12

Info Mode

Information Screen	13
Counters Screen	13
Counters Screen - Fault Log	13
Options Screen	14
Options Screen - Editing	14
Options Screen - Cook More	14
Options Screen - Load Menu	14
Options Screen - VAC	14
Options Screen - Demo Mode	14
Options Screen - Manual Cooking	14
Options Screen - Diagnostic Mode	14
Options Screen - F2 Bypass	14
Settings Screen	14
Settings Screen - Temperature Measurement	14
Settings Screen - Language	14
Settings Screen - WiFi Network	15
Settings Screen - Volume	15
Settings Screen - Date	15
Settings Screen - Time	16
Settings Screen - Cooling	16
Service Screen	16
MFG Screen	16

Edit Mode

Edit Set Temperature	16
Edit Item Settings and Menu/Group/Item Names	16

Loading and Saving Menus	18
--------------------------	----

Troubleshooting	19
-----------------	----

North America Limited Warranty	21
--------------------------------	----

International Limited Warranty	23
--------------------------------	----

This Page Left Intentionally Blank

IMPORTANT SAFETY INSTRUCTIONS

WARNING: When operating this oven, strictly adhere to the following safety precautions to reduce the risk of burns, electric shock, fire, injury, damage to oven or property near oven.

GENERAL SAFETY INFORMATION

- ✓ Read all instructions before using this appliance.
- ✓ This appliance must be grounded. Connect only to a properly grounded outlet. See “Grounding Instructions” on page ii.
- ✓ Install or locate this appliance only in accordance with the provided installation instructions.
- ✓ This appliance should be serviced by qualified service personnel only. Contact the nearest authorized service facility for examination, repair, or adjustment.
- ✓ Keep the cord away from heated surfaces.
- x DO NOT use corrosive chemicals or vapors in this appliance; it is not designed for industrial/laboratory use.
- x DO NOT allow children to use this appliance.
- x DO NOT operate this appliance if it has a damaged cord or plug, is not working properly, or has been damaged or dropped. See “Power Cord Replacement” found on page ii.
- x DO NOT cover or block any openings on this appliance.
- x DO NOT store this appliance outdoors.
- x DO NOT use this product near water (e.g., near a kitchen sink, in a wet basement, near a swimming pool).
- x DO NOT immerse the cord or plug in water.
- x DO NOT let the cord hang over the edge of a table or counter.
- x DO NOT use a water jet for cleaning.
- x **WARNING:** Due to the nature of the appliance, the floors around it may be slippery.
- x This appliance is not to be used by children or persons with reduced physical, sensory or mental capabilities, or lack of experience and knowledge, unless they have been given supervision or instruction.

REDUCING FIRE RISK

- ✓ If materials inside the oven ignite, keep the oven door closed, turn the oven off, and disconnect the power cord or shut off power at the fuse or circuit breaker panel.
- ✓ If smoke is observed, switch off or unplug the oven. Keep the doors closed to stifle any flames.
- x DO NOT use the cook cavity for storage purposes.
- x DO NOT overcook food. Carefully attend to the oven if paper, plastic, or other combustible materials are placed inside the oven to facilitate cooking.
- x DO NOT leave paper products, cooking utensils, or food in the cavity when the oven is not in use.

GROUNDING INSTRUCTIONS

This appliance must be grounded. In the event of an electrical short circuit, grounding reduces the risk of electric shock by providing an escape wire for the electric current. This oven is equipped with a cord that has a grounding wire with a grounding plug (for international voltages, a plug could be attached at the time of oven installation), which must be plugged into an outlet that is properly installed and grounded. Consult a qualified electrician or serviceman if uncertain about the ability to follow grounding instructions or if in doubt as to whether the appliance is properly grounded.

- x DO NOT use an extension cord. If the power cord is too short, have a qualified electrician or serviceman install an outlet near the appliance.

 **WARNING:** Improper grounding can result in risk of electric shock.

POWER CORD REPLACEMENT OR REMOVAL

If the power cord is damaged, it must be replaced by the manufacturer, its service agent, or a similarly qualified person.

 **WARNING:** If the oven is unplugged during service or maintenance, the user must be able to access and see the plug at all times to ensure that the oven remains unplugged. The plug must remain near the oven and cannot be placed behind another appliance or in another room.

PROTECTIVE EARTH (GROUND) SYMBOL



This symbol identifies the terminal which is intended for connecting an external conductor for protection against electric shock in case of a fault, or the terminal of a protective earth (ground) electrode.

EQUIPOTENTIAL BONDING SYMBOL



This symbol identifies the terminals which, when connected together, bring the various parts of an equipment or of a system to the same potential, not necessarily being the earth (ground) potential, e.g. for local bonding.

SAVE THESE INSTRUCTIONS

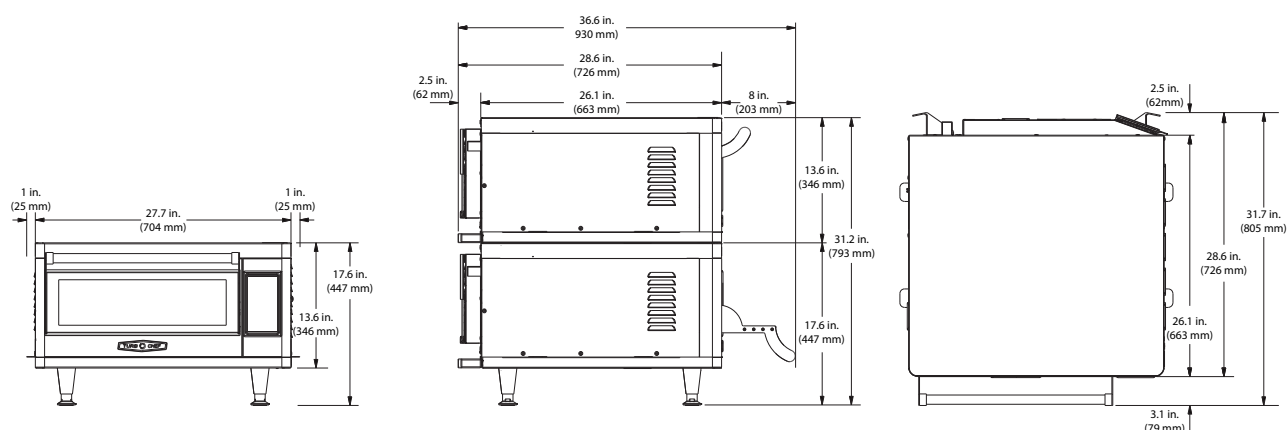

Figure 1: Single Batch Oven Dimensions

Theory of Operation

Utilizing TurboChef's patented technology to rapidly cook food without compromising quality, the Single Batch oven provides superior cooking performance while requiring minimal space and energy consumption. The oven circulates impinged air at speeds of up to 50 mph to create high heat transfer rates and reduce cook time. The technology includes utilizing a variable speed blower, oscillating rack, and catalytic converter, resulting in minimal energy input, high food quality, and UL®-certified ventless operation (see page 4 for details).

This manual includes instructions for installing, cleaning, and operating Single Batch ovens. If you have questions that are not addressed in this manual, contact Customer Support at 800.90TURBO (+1 214.379.6000) or your Authorized Distributor.

Features

- Simple and intuitive touch controls
- Multi-language user interface
- Variable-speed High h recirculating air impingement system
- Oscillating rack for high heat transfer without spotting
- Half-sheet pan/16-inch pizza capacity
- Stackable design (requires stacking kit)
- Smart menu system capable of storing up to 400 recipes
- Built-in self diagnostics for monitoring oven components and performance
- USB and Wi-Fi ready

Dimensions

Oven Dimensions

Height (single oven): 17.6" (447 mm)
 Height (stacked ovens): 31.2" (793 mm)
 Width: 27.7" (704 mm)
 Depth (door closed): 31.7" (806 mm)
 Depth (door open): 36.6" (930 mm)
 Weight: 153 lb. (69.4 kg)

Cook Cavity Dimensions

Height/Usable Height: 5.5" (140 mm)/4.35" (110 mm)
 Width: 18.7" (475 mm)
 Depth/Usable Depth: 16.7" (424 mm)/16.25" (413 mm)
 Volume: 0.99 cu.ft. (28.1 liters)

Clearances

Top: 2" (51 mm)
 Sides: 2.5" (64 mm)

Certifications

cULus, UL EPH, FDA



Oven Construction

Exterior

- Stainless steel front, top, and sides
- 4" (102 mm) legs
- Marine hardware

Interior

- 304 stainless steel
- Fully insulated cook chamber
- Top and bottom jetplates
- Marine hardware

Electrical Specifications

TurboChef recommends a Type D circuit breaker for European installations.

Single Phase

US/Canada: 208/240 VAC*, 50/60 Hz, 27 A, 5,616 watts

MK International: 230 VAC, 50 Hz, 30 A, 5,616 watts

Three Phase

MD International: 230 VAC, 50 or 60 Hz, 25 A, 5,520 watts

MW International: 400 VAC, 50 or 60 Hz, 16 A, 5,520 watts

* US/Canada models include a voltage sensor that detects 208 or 240 VAC, but does not compensate for lack-of or over-voltage installations.

Installation

Install or locate this appliance only in accordance with the instructions below.

Unpacking Instructions

1. Remove the oven from its packaging.
2. Before discarding, check the packaging thoroughly for accessories and literature.

NOTE: Packaging may also be retained in case the oven may at some point be shipped somewhere else or returned to the manufacturer.

3. Check the cook cavity thoroughly for accessories and literature.
4. Discard any packaging in the cook cavity.

Installation Warnings - Read Before Lifting Oven

 **WARNING:** The Single Batch oven weighs approximately 153 lb. (69.4 kg). Never lift with fewer than two people.

 **WARNING:** Never lift the oven from the front and rear or by the door handle. Doing so will cause the door to misalign, resulting in a non-warranty service call.

 **WARNING:** The oven must be properly placed on a food station at all times. TurboChef will not recognize a fallen oven as a warrantable claim and is not liable for any injuries that may result.

 **WARNING:** This oven is not intended for built-in installation (i.e., installing the oven in any structure that surrounds the oven by five or more sides). Be sure to provide a minimum of 2.5" (64 mm) clearance for all sides and 2" (51 mm) clearance for the top.

 **WARNING:** This oven is intended to be stacked only with the appropriate hardware. Contact TurboChef for details.

Lifting and Placing the Oven

1. Prepare a surface at least 28.6" (726 mm) deep and capable of supporting 153 lb. (69.4 kg).
2. Position one or more persons at the left and right sides of the oven.
3. Place hands under the oven and lift.
4. Place the oven on the prepared surface, ensuring no edges are hanging off the sides.
5. Ensure the oven rack is properly installed. When properly installed, the rack rests on oscillating pins.
6. Plug in the oven.

Installation Near Open Heat Source

When placing a TurboChef oven near an open heat source (Figure 2), strictly adhere to the following:

- If the oven is being placed near a grill or stove, a divider must exist between the oven and the open heat source, with a minimum of 6" (152 mm) between the oven and the divider.
- If the oven is being placed near a fryer, a divider must exist between the oven and fryer, with a minimum of 12" (305 mm) between the oven and the divider.
- The height of the divider must be greater than or equal to the height of the oven (17.6" or 447 mm).
- Verify the oven location has a minimum 2" (51 mm) clearance on top and a minimum 2.5" (64 mm) clearance on each side.

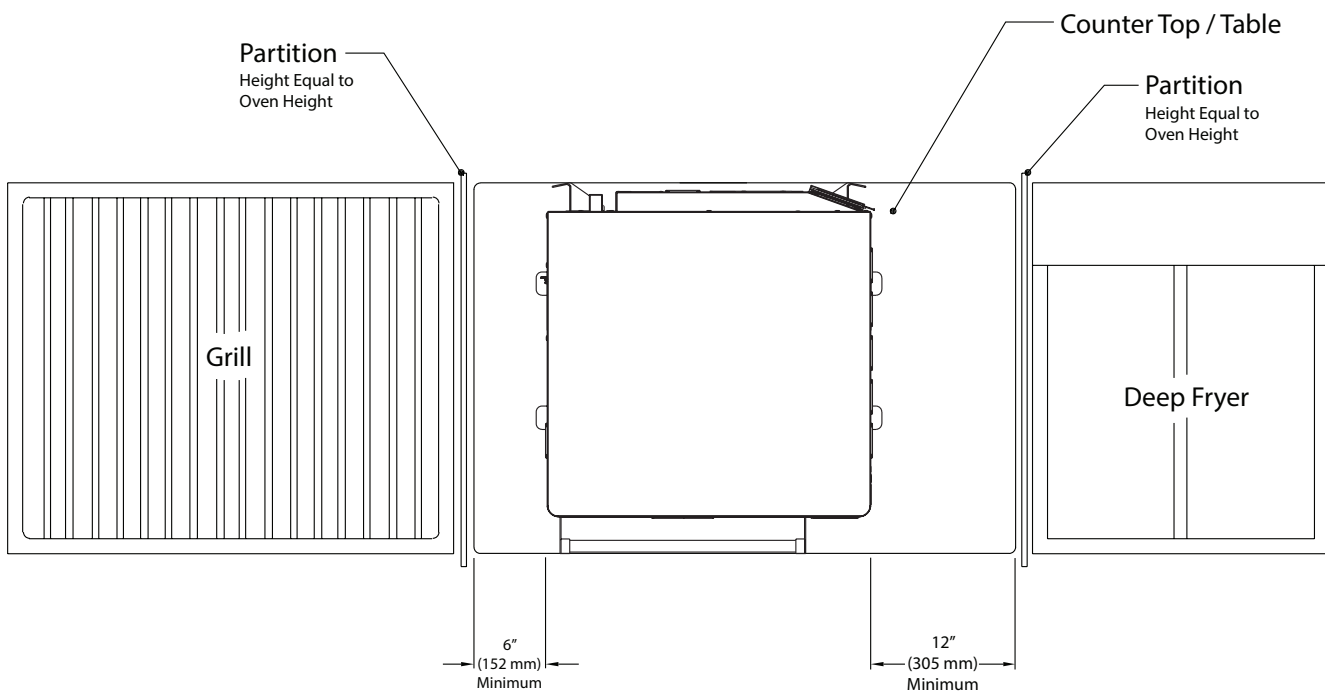

Figure 2: Installation Near Open Heat Source

Oven Restraint Kit

Part Number: TC3-0242



WARNING: The Oven Restraint Kit will not prevent the oven from falling off a countertop if the oven is pulled off or allowed to slide off the edge. Installation instructions are included with the kit.

TurboChef Connect™

TurboChef Connect™ allows you to remotely update the menu for ovens that are connected via WiFi. TurboChef Connect™ also includes reporting tools and live data streams to view what is being cooked and when. You can also receive alerts via email.

For more information, call TurboChef Customer Support at 800.90TURBO or +1 214.379.6000.

ChefComm Pro®

Part Number: CON-7006

ChefComm Pro® lets you easily create menu settings on a computer and upload them to an oven via USB. For more information, call TurboChef Customer Support at 800.90TURBO or +1 214.379.6000.

Date and Time Prompt

The oven maintains a data log that contains valuable information about the operation of the oven, including faults, items cooked, and other events. An accurate date and time are important for the data log. If the oven loses the date and time as a result of prolonged disconnection from power, a prompt will alert the operator to set the date and time. The prompt will only occur whenever power is cycled. If bypassed, the operator must update the date and time from the Info Mode Settings screen.

Voltage Selection

For North America oven models, the oven will detect 208 or 240 incoming voltage.

If incoming voltage for the store is different than the factory-preset voltage, the operator will be required to select either 208 or 240. The correct voltage will be highlighted on the screen, identifying which option to touch (see Figure 3 below).



Figure 3: Selecting Voltage

Ventilation

The TurboChef Single Batch ovens have been approved by Underwriter's Laboratory® for ventless operation (UL KNLZ listing) for all food items except for foods classified as "fatty raw proteins." Such foods include bone-in, skin-on chicken, raw hamburger meat, raw bacon, raw sausage, steaks, etc. If cooking these types of foods, consult local HVAC codes and authorities to ensure compliance with ventilation requirements.

To ensure continued compliance with all health, building, and fire codes, you are required to maintain clean and sanitary conditions around your oven at all times.

NOTE: In no event shall the manufacturer assume any liability for damages or injuries resulting from installations which are not in compliance with the instructions and codes previously listed. Failure to comply with these instructions could result in the issuance of a temporary cease and desist order from the local health department until the environment concerns are addressed.

Daily Maintenance

The following steps will help maintain your oven. Use only TurboChef Oven Cleaner and Oven Guard. The use of any other cleaning products can damage critical oven components, resulting in a non-warranty service call.



Step 1



Step 2

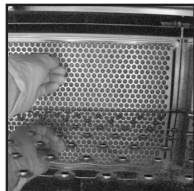

Step 3

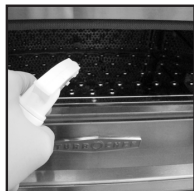

Step 4



Step 5.1



Step 5.2

Supplies and Equipment

- TurboChef Oven Cleaner (Part Number: 103180)
- TurboChef Oven Guard (Part Number: 103181)
- Nylon scrub pad, cleaning towel, disposable gloves, protective eyewear, dust mask (optional)

Step 1: Prepare the Oven

⚠️ WARNING: The oven operates at temperatures up to 550°F (285°C) and may cause injury if not allowed to cool properly.

- Turn the oven off by touching the Off icon on oven screen.
- Open the oven door.
- DO NOT attempt to clean until the oven display no longer reads “Cooling Down.”

NOTE: To expedite cooling, leave the oven door open and insert a tray of ice into the cavity.

Step 2: Remove and Clean the Wire Rack

⚠️ WARNING: Be sure the oven interior is cool before you remove the wire rack.

- Wash, rinse, and sanitize the wire rack.

Step 3: Remove and Clean the Grease Filter

- Lift the grease filter by the handle and pull forward.
- Wash and gently rinse the grease filter with hot water.

⚠️ WARNING: DO NOT scrub the grease filter or use a water jet when cleaning.

Step 4: Clean the Cook Chamber

- Use a food vacuum or damp towel to remove food particles from the cook chamber.
- Spray oven cleaner onto the top, bottom, and sides of the oven interior.

⚠️ CAUTION: DO NOT spray Oven Cleaner into the holes on the back oven wall or directly onto the cook chamber lamps. Doing so can damage critical oven components, resulting in a non-warranty service call.

- For stubborn stains, spray Oven Cleaner and allow it to penetrate for 5 minutes.
- Clean the oven interior with a nylon scrub pad.
- Wipe the cook chamber with a clean damp towel, and then a dry towel.

Step 5: Clean the Oven Door

- Clean the metal portion of the oven door with Oven Cleaner and a nylon scrub pad.
- Gently clean the glass window with Oven Cleaner and a cleaning towel.

⚠️ CAUTION: DO NOT use abrasive cleaning supplies (e.g. steel wool) when cleaning the glass window. Doing so may scratch the window.

⚠️ CAUTION: DO NOT apply excessive force when cleaning the glass window. Breakage will result in a non-warranty service call.

- Wipe the door and window with a clean, damp towel and then a dry towel.

⚠️ CAUTION: DO NOT scrub or attempt to clean the oven door gasket (Figure Step 5.2). Doing so may cause the oven doors to mis-align, resulting in a non-warranty service call.

Continued on Page 6...



Step 6

Step 6: Apply Oven Guard

- Spray Oven Guard onto a clean towel.
- Wipe the interior walls and the inside of the oven door.

⚠ CAUTION: DO NOT spray Oven Guard into the holes on the back oven wall or directly onto the cook chamber lamps. Doing so can damage critical oven components, resulting in a non-warranty service call.



Step 7

Step 7: Reinstall the Grease Filter and Wire Rack

- There are notches on the rear right and left sides of the wire rack which fit over the pins on the sides of the cook chamber. The wire rack must be installed correctly to ensure proper oven operation.

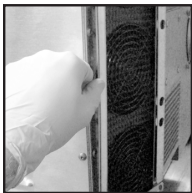

Step 8

Step 8: Clean the Air Filter

⚠ CAUTION: TurboChef does not recognize blocked air vents as a warrantable claim. The filter must be cleaned regularly or replaced if damaged. During oven operation, the filter must remain in place at all times.

- Remove the air filter from the back of the oven.
- Rinse the air filter with hot water. DO NOT scrub the filter.
- Allow the air filter to dry completely.
- Reinstall the air filter.

⚠ CAUTION: DO NOT operate the oven without the filter in place.



Step 9

Step 9: Clean the Oven Exterior

- Wipe the oven exterior with a clean, damp towel.

⚠ CAUTION: DO NOT spray chemicals into any openings, such as the louvers on the side or rear panels. Doing so can damage critical oven components, resulting in a non-warranty service call.

- Wipe the oven exterior with a clean, dry towel.

Weekly Maintenance

Once a week (or more frequently depending on use), perform the following steps to help maintain your oven. Use only TurboChef Oven Cleaner and Oven Guard. The use of any other cleaning products can damage critical oven components, resulting in a non-warranty service call.



Step 1



Step 2

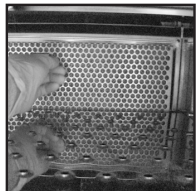

Step 3

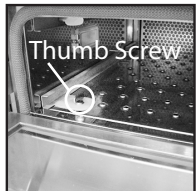

Step 4.1

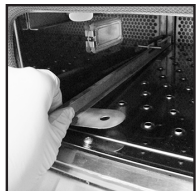

Step 4.2



Step 4.3



Step 5

Supplies and Equipment

- TurboChef Oven Cleaner (Part Number: 103180)
- TurboChef Oven Guard (Part Number: 103181)
- Nylon scrub pad, cleaning towel, disposable gloves, protective eyewear, dust mask (optional)

Step 1: Prepare the Oven

⚠ WARNING: The oven operates at temperatures up to 550°F (285°C) and may cause injury if not allowed to cool properly.

- Turn the oven off by touching the Off icon on oven screen.
- Open the oven door.
- DO NOT attempt to clean until the oven display no longer reads “Cooling Down.”

NOTE: To expedite cooling, leave the oven door open and insert a tray of ice into the cavity.

Step 2: Remove and Clean the Wire Rack

⚠ WARNING: Be sure the oven interior is cool before you remove the wire rack.

- Wash, rinse, and sanitize the wire rack.

Step 3: Remove and Clean the Grease Filter

- Lift the grease filter by the handle and pull forward.
- Wash and gently rinse the grease filter with hot water.

⚠ WARNING: DO NOT scrub the grease filter or use a water jet when cleaning.

Step 4: Remove and Clean the Bottom Jetplate

- Remove the left and right support rails by pulling up on the thumb screws and unscrewing them until there is enough clearance to remove the rail (Figure *Step 4.1*), and then gently pulling the rails out and away from the oven (Figure *Step 4.2*).
- Remove the bottom jetplate (Figure *Step 4.3*).
- Wash, rinse, and sanitize the bottom jetplate.

Step 5: Clean the Cook Chamber

- Use a food vacuum or damp towel to remove food particles from the cook chamber.
- Spray oven cleaner onto the top, bottom, and sides of the oven interior.

⚠ CAUTION: DO NOT spray Oven Cleaner into the holes on the back oven wall or directly onto the cook chamber lamps. Doing so can damage critical oven components, resulting in a non-warranty service call.

- For stubborn stains, spray Oven Cleaner and allow it to penetrate for 5 minutes.
- Clean the oven interior with a nylon scrub pad.
- Wipe the cook chamber with a clean damp towel, and then a dry towel.

Continued on Page 8...



Step 6.1



Step 6.2



Step 7



Step 8

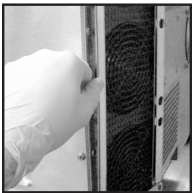

Step 9



Step 10

Step 5: Clean the Oven Door

- Clean the metal portion of the oven door with Oven Cleaner and a nylon scrub pad.
- Gently clean the glass window with Oven Cleaner and a cleaning towel.

⚠ CAUTION: DO NOT use abrasive cleaning supplies (e.g. steel wool) when cleaning the glass window. Doing so may scratch the window.

⚠ CAUTION: DO NOT apply excessive force when cleaning the glass window. Breakage will result in a non-warranty service call.

- Wipe the door and window with a clean, damp towel and then a dry towel.

⚠ CAUTION: DO NOT scrub or attempt to clean the oven door gasket (Figure *Step 5.2*). Doing so may cause the oven doors to mis-align, resulting in a non-warranty service call.

Step 6: Apply Oven Guard

- Spray Oven Guard onto a clean towel.
- Wipe the interior walls and the inside of the oven door.

⚠ CAUTION: DO NOT spray Oven Guard into the holes on the back oven wall or directly onto the cook chamber lamps. Doing so can damage critical oven components, resulting in a non-warranty service call.

Step 8: Reinstall the Bottom Jetplate, Left and Right Support Rails, Grease Filter, and Wire Rack

- There are notches on the rear right and left sides of the wire rack which fit over the pins on the sides of the cook chamber. The wire rack must be installed correctly to ensure proper oven operation.

Step 9: Clean the Air Filter

⚠ CAUTION: TurboChef does not recognize blocked air vents as a warrantable claim. The filter must be cleaned regularly or replaced if damaged. During oven operation, the filter must remain in place at all times.

- Remove the air filter from the back of the oven.
- Rinse the air filter with hot water. **DO NOT** scrub the filter.
- Allow the air filter to dry completely.
- Reinstall the air filter.

⚠ CAUTION: DO NOT operate the oven without the filter in place.

Step 10: Clean the Oven Exterior

- Wipe the oven exterior with a clean, damp towel.

⚠ CAUTION: DO NOT spray chemicals into any openings, such as the louvers on the side or rear panels. Doing so can damage critical oven components, resulting in a non-warranty service call.

- Wipe the oven exterior with a clean, dry towel.

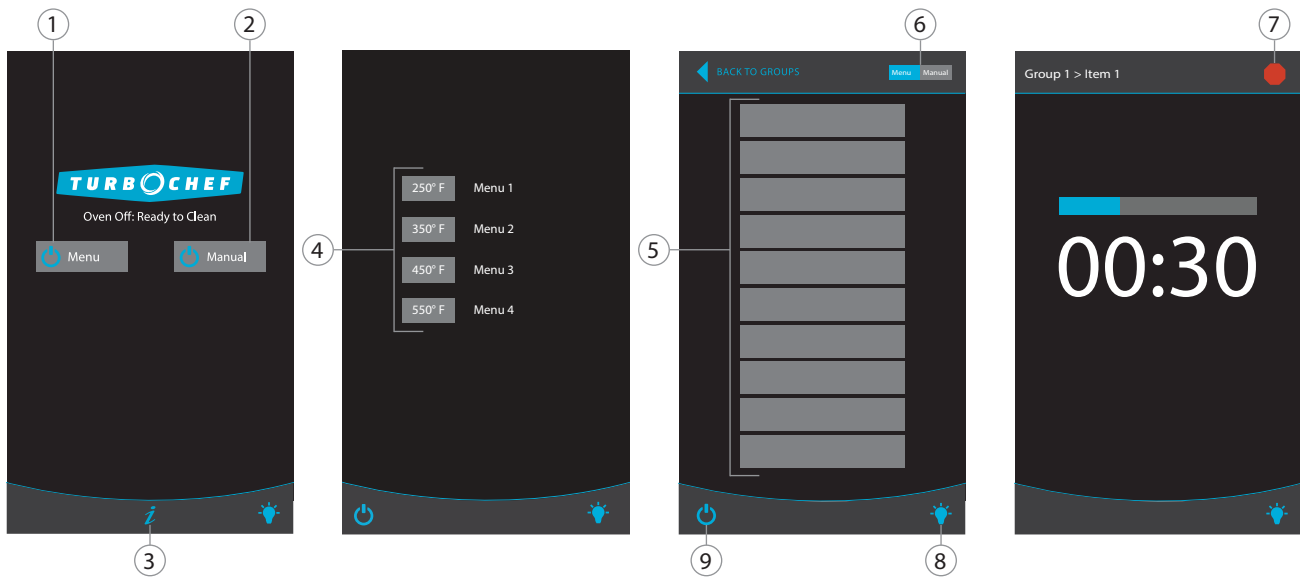

Figure 4: Oven Controls

NOTE: Display options vary depending on which features are enabled.

Oven Controls

1. **Menu Icon/Power Icon**
Touch to turn the oven on and cook in Menu Cook Mode (page 10).
2. **Manual Icon**
Touch to turn the oven on and cook in Manual Cook Mode (page 12). The Manual icon is only present if enabled from the options screen (page 14).
3. **“i” Icon**
Touch to access Info Mode. The “i” icon is only displayed when the oven is off or cooling down.
4. **Menu Select**
The oven contains 4 menus. Touch to select the menu you wish to cook. Each menu contains 10 groups.
5. **Groups/Items**
Touch to select the Group/Item you wish to cook. Each group contains 10 items.
6. **Menu/Manual Toggle**
The Menu/Manual toggle will only be displayed when manual cooking is enabled and will allow you to switch between menu mode (page 10) and manual mode (page 12).
7. **Stop Icon**
Touch to immediately terminate a cook cycle.
8. **Light Icon**
Touch to turn the oven light on and off.
9. **Off Icon**
Touch to turn the oven off (cool down).

Menu Cook Mode

The oven is preprogrammed with recipe settings at the time of manufacture and is ready to operate out of the box. New menu settings can be loaded via USB, WiFi, or programmed manually. If settings are not present, the oven will cook only in manual mode (page 10).

The Single Batch oven uses impingement to create high heat transfer rates and reduce cook time. Air enters the cavity from the top and bottom and is distributed by the jetplates. Because of this design and to ensure uniformity of cooking, the top and bottom jetplates must be installed during operation.

The sequence of the steps below may vary and some may not apply.

Step 1: Touch the “Menu” Icon to Turn the Oven On

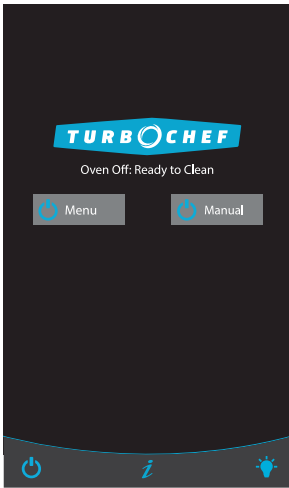

Step 2: Select a Menu



Step 3: Warming Up

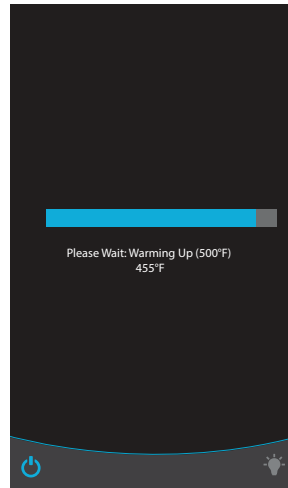

NOTE: When the oven is done warming up, it will “soak” for an additional eight minutes. “Soaking” ensures the cavity surfaces absorb enough heat so that cooking will not be affected.

Step 4: Place Food in the Oven

 **WARNING:** Inside of oven and door is hot!

Step 5: Select a Group



Step 8: Check/Remove Food from Oven

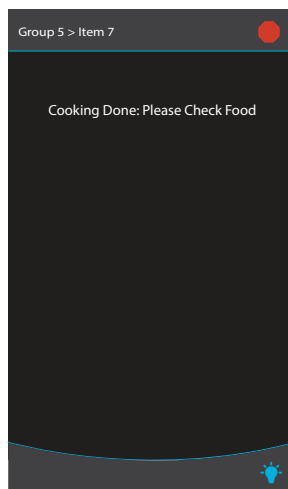

⚠ WARNING: Dish/inside of oven and door is hot!

Step 6: Select an Item

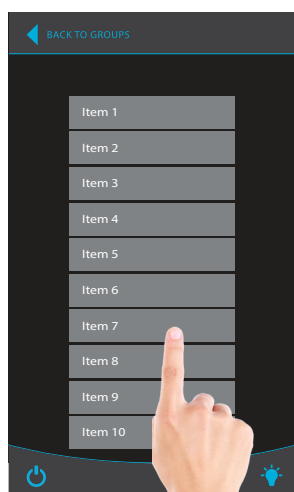

Step 9: Cook More

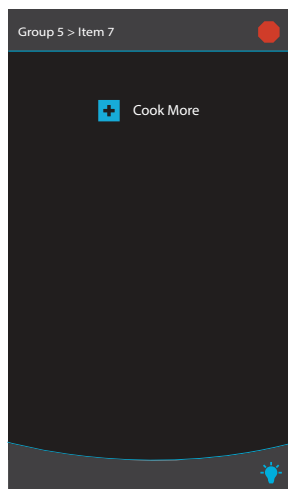

NOTE: This option must be enabled from the Options Screen (page 14) in order to cook an item beyond its original cook time.

Touch “Cook More” to cook the item for 20% longer with 100% air.

Step 7: Cooking

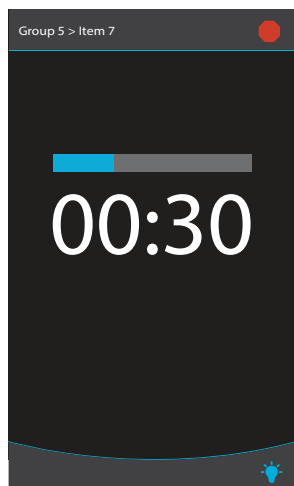

NOTE: To immediately terminate a cook cycle, touch the red “STOP” icon.

NOTE: If the oven door is opened during a cook cycle, the cycle will pause until the door is closed.

Step 10: Cooling Down

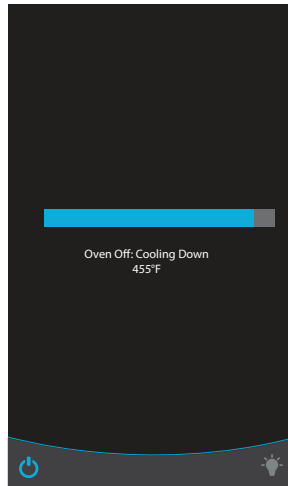

When finished cooking for the day, touch “OFF” to begin cooling down.

Manual Cook Mode





Manual Cook Mode is intended for professionals, and allows cooking “on the fly,” whereas Menu Cook Mode (page 10) allows cooking from preset cook settings. To access Manual Cook Mode, touch the Manual icon when the oven is off or cooling down (page 11) or touch the Menu/Manual toggle on the Menu Mode screen. Manual Cooking can be enabled and disabled from the Options Screen (page 14).

To cook an item in Manual Cook Mode, adjust the settings using the icons on the screen, allow the oven to warm or cool to the set temperature, and touch the cook icon.

1. % Air





% Air determines the amount of airflow.

The more air, the more the product will brown or crisp. % Air can be set from 10-100% in 5% increments. There are four air icons.

-   Clear air setting
-  Add 5%
-  Add 10%
-  Add 25%

2. Cook Time

Time can be set from 00:05-99:55 (mm:ss). There are four time icons.

-   Clear (or “zero”) the time
-  Add 5 seconds
-  Add 30 seconds
-  Add 60 seconds

3. Set Temperature

Touch to change the set temperature. The temperature range is 300–550°F in 25°F increments (150–285°C in 10-15°C increments).

4. Cook

Touch to cook.

NOTE: The oven may require additional warming time before cooking can be performed.

5. Off Icon

Touch to turn the oven off (cool down).

6. Light Icon

Touch to turn the oven light on and off for the top/bottom oven.

7. Menu/Manual Toggle

Switch between Menu Cook Mode (page 10) and Manual Cook Mode.

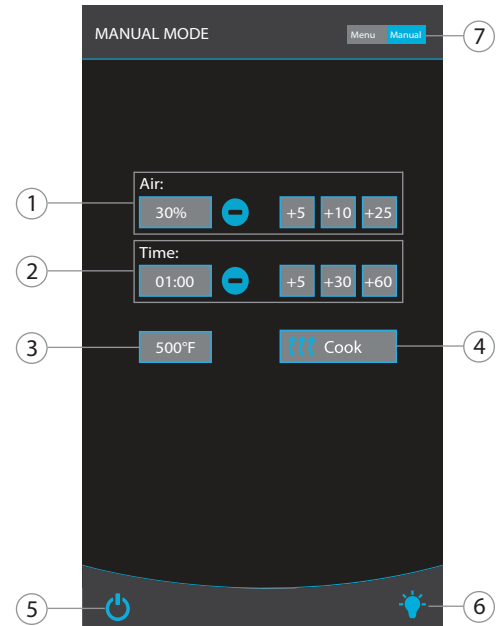

Figure 5: Manual Cook Mode

Info Mode

To access Info Mode, touch the “i” icon when the oven is off or cooling down. From the Info Mode screen (Figure 6), access:

- Information screen
- Counters screen
- Options screen
- Settings screen
- Service mode
- MFG mode

To access each screen, touch the corresponding icon (e.g. touch “COUNTERS” to access the Counters screen).

The Options, Settings, Service, and MFG screens require a passcode to access. Touch “Login” and, when prompted, input the password 9 4 2 8 and touch the check icon in the bottom-right corner of the screen (Figure 7).

Information Screen

From the Information screen (Figure 8), view:

- Serial Number
- Menu Version
- Sage Firmware Version
- Phoenix Firmware Version
- Service Number
- Language
- VAC (Voltage) - View Incoming

Counters Screen

From the Counters screen (Figure 9), view:

- Cook Counter
- Total Cook Time in cumulative hours
- Total Time (oven on) in cumulative hours
- Power Cycles: The number of times the oven has cycled power.
- Erase Counters (not recommended)
- Fault Log

Counters Screen - Fault Log

The fault log is split into the “Count” screen and the “History” screen.

Count Screen: Displays the number of times a fault has occurred (Figure 10).

History Screen: Displays the timestamp of each fault occurrence (Figure 11).

Touch the “COUNT” / “HISTORY” toggle on the left-side of the screen to switch between these screens.

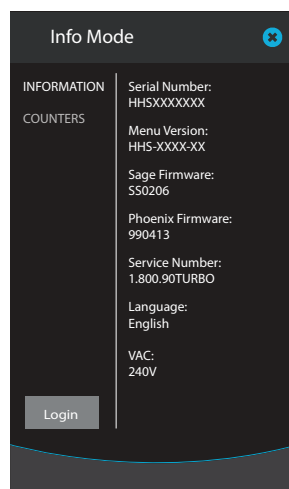

Figure 6: Info Mode

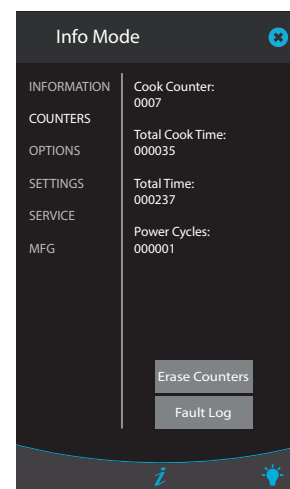

Figure 9: Counters Screen

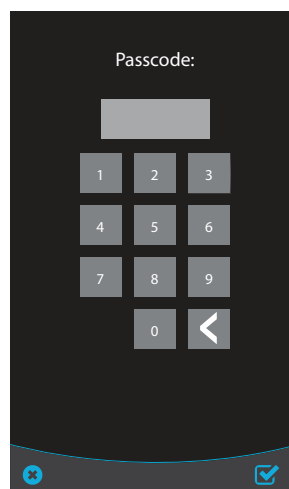

Figure 7: Passcode Screen

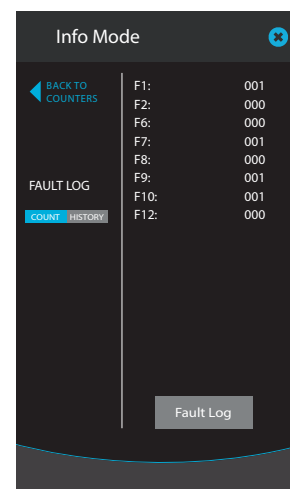

Figure 10: Fault Log - Count



Figure 8: Information Screen

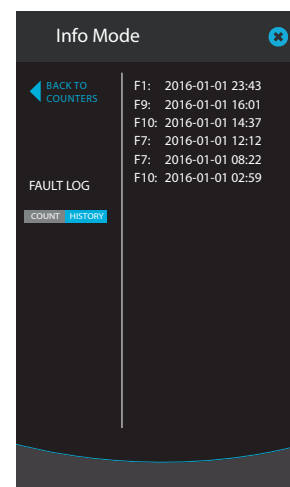

Figure 11: Fault Log - History

Options Screen

From the options screen (Figure 12), enable/disable:

- Editing
- Cook More
- Load Menu
- VAC
- Demo Mode
- Manual Cooking
- Diagnostic Mode
- F2 Bypass

You must enter the passcode 9 4 2 8 to access this screen; see page 13 for more details.

Options Screen - Editing

This toggle changes the oven between standard Menu Mode and Edit Mode. For more information on Edit Mode, see page 16.

Options Screen - Cook More

Cook More controls whether or not the “Cook More” option appears when a cook cycle is done. This option must be enabled in order to cook an item beyond its original cook time. See page 11 for details.

Options Screen - Load Menu

Load Menu enables or disables the “load menu” option on the USB detection screen. See page 18 for more details.

Options Screen - VAC

When VAC is set to YES the incoming voltage will be displayed on the Info screen. This is set by the factory and should not be changed.

Options Screen - Demo Mode

Demo Mode is a feature used to demonstrate the cooking features of the oven without turning on the heaters. Demo Mode must be set to NO during regular operation.

Options Screen - Manual Cooking

When Manual Cooking is set to YES, the operator can cook items “on the fly.” See page 12 for more details.

Options Screen - Diagnostic Mode

Diagnostic Mode allows service technicians to view and test oven components. Diagnostic Mode should be set to NO during regular operation.

Options Screen - F2 Bypass

If F2 Bypass is set to YES, the oven will log an F2 fault condition should one occur, but it will not terminate a cook cycle. If F2 bypass is set to NO, then the oven will terminate a cook cycle upon discovery of an F2 fault condition.

Settings Screen

From the Settings screen (Figure 13), set:

- Temperature
- Language
- WiFi Network
- Volume
- Date
- Time
- Cooling

You must enter the passcode 9 4 2 8 to access this screen; see page 13 for more details.

Settings Screen - Temperature Measurement

The temperature measurement setting is configured at the factory. Touch the toggle to change between °F (Fahrenheit) and °C (Celsius).

Settings Screen - Language

The default language is English. To change to another language, touch “Language: English” and then touch the preferred language and touch “ENTER.”

NOTE: Some ovens will not include multiple languages.



Figure 12: Options Screen

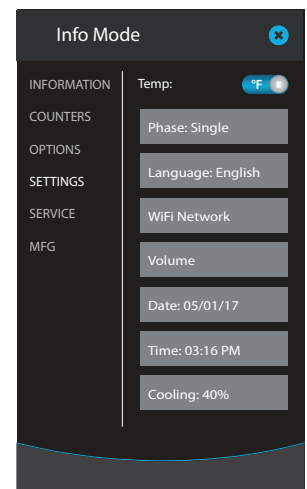

Figure 13: Settings Screen

Settings Screen - WiFi Network

Connecting the oven to a WiFi network and utilizing TurboChef's connectivity service (TurboChef Connect) allows you to remotely update the menu for one or all of your ovens and enables access to reporting tools and live data streams to view what is being cooked and when. TurboChef Connect also allows you to receive alerts via email.

Special instructions for corporate/chain customers may be required. Contact your facility administrator for more information.

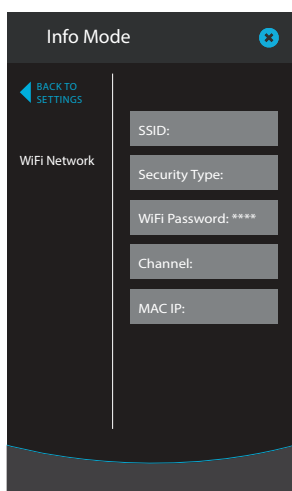

Figure 14: WiFi Screen

SSID

The SSID is the case-sensitive name of the WiFi network that the oven will join. After touching the SSID icon, use the on-screen keyboard to type in the WiFi network name and touch the check icon in the bottom-right corner of the screen.

If you are unsure of the SSID for the network, contact your network administrator. In some instances, the SSID may be printed on a label on the bottom of your WiFi router.

Security Type

The Security Type is set by your WiFi router. After touching "Security Type," select the security type being used by your router: Open, WPA, WPA2, WEP.

After selecting the correct Security Type, touch the check icon in the bottom-right corner of the screen.

If you are unsure of the Security Type being used by the network, contact your network administrator. In some instances, the Security Type may be printed on a label on the bottom of your WiFi router.

WiFi Password

The WiFi Password is the case sensitive password needed to join the WiFi network. After touching the WiFi Password icon, use the on-screen keyboard to type in the WiFi network password and touch the check icon in the bottom-right corner of the screen.

If you are unsure of the WiFi Password for the network, contact your network administrator. In some instances, the WiFi Password may be printed on a label on the bottom of your WiFi router.

⚠️ NOTE: "Open" networks do not use WiFi passwords. Clear or leave this field empty when using the oven on an "Open" network. Additional permissions at the router may be required for use on open networks. Contact your network administrator for assistance.

Channel

The Channel is reported by the WiFi router. It is not changeable on the oven.

NOTE: If you are experiencing connectivity problems, TurboChef recommends setting the WiFi router's channel to 1.

Change the network channel by logging into your router. For help with your WiFi router, contact your network administrator.

MAC IP

The MAC IP is automatically assigned to the embedded wireless device. A visible MAC IP confirms the module is installed properly.

Settings Screen - Volume

Touch "Volume" and use the plus or minus icons to increase or decrease the volume of the oven's speaker. See Figure 12, page 14.

Settings Screen - Date

An accurate date is necessary for ensuring the accuracy of diagnostics and fault condition reporting on the oven.

NOTE: The oven may not retain the date if left unplugged for a prolonged period of time.

To set the date, touch "Date" and enter the date in the following format - MM/DD/YY. Touch the check icon in the bottom-right corner of the screen to save the changes. See Figure 13, page 14.

Settings Screen - Time

An accurate time is necessary for ensuring the accuracy of diagnostics and fault condition reporting.

NOTE: The oven may not retain the time if left unplugged for a prolonged period of time.

NOTE: The clock will not automatically update for Daylight savings time.

To set the time, touch “Time” and enter the time in 24-hour format (8:30 p.m. = 20:30). Touch the check icon in the bottom-right corner of the screen to save the changes. See Figure 13, page 14.

Settings Screen - Cooling

Touch “Cooling” to increase the cooling fan speed in 5% increments (from 30% to 80%) during “Cooling Down” (Page 11). See Figure 13, page 14.

NOTE: TurboChef recommends 50% setting for optimal cooling.

Service Screen

Only qualified service technicians should access the service options, unless otherwise instructed by TurboChef.

MFG Screen

Only qualified service technicians should access the MFG options, unless otherwise instructed by TurboChef.

Edit Mode

Edit Mode allows the operator to:

- Edit the set temperatures.
- Edit item settings, group names, and item names.

Editing can be enabled and disabled from the Options screen (page 14).

Edit Set Temperature

See Figure 15, page 17.

The menu set temperature should never be changed to compensate for over-cooking or under-cooking. If recipe settings are not cooking as desired, consult your menu developer, authorized distributor, or TurboChef Customer Support.

The set temperature can be edited in the group select screen (Figure 15, Page 17). Touch the temperature icon to increase the Set Temperature by 25°F (15°C). The temperature range is 300–550°F (150–285°C).

Edit Item Settings and Menu/Group/Item Names

See Figure 17, page 17.

To edit settings, menu names, group names, and item names, select a group (Figure 15, page 17) and item (Figure 16, page 17) to edit.

1. Menu/Group/Item Name

Touch the field you wish to edit and use the onscreen keyboard (Figure 18, page 17) to rename it.

NOTE: Touch the  icon to change the letter case.

NOTE: Touch the ALT icon to access special characters.

NOTE: Touch the &% icon to access symbols.

2. Event %Time

Each item can have up to four events. To set the amount of time for each event, touch the  icon that contains the percentage you wish to change. The time can be set from 0-100% (in 5% increments) for each event.

NOTE: The sum of all events must be 100; otherwise the oven will not allow the changes to be saved.

3. Event %Air

To set the amount of airflow used in each event, touch the  icon that contains the percentage you wish to change. The airflow can be set from 10-100% (in 5% increments) for each event.

4. Increase and Decrease

Touch these icons to increase or decrease the selected %Air or %Time events in 5% increments.

5. Total Cook Time

Displays the total cook time for the item.

6. Set Cook Time Icons

Time can be set from 00:05-99:55 (mm:ss). There are four time icons.

- 01:00 Clear (or “zero”) the time
- +5 Add 5 seconds
- +30 Add 30 seconds
- +60 Add 60 seconds

7. Cancel

Touch this icon to cancel all changes made to this item and return to the item select screen.

8. Save

Touch this icon to save all changes made to this item and return to the item select screen.

NOTE: While test cooking and developing your recipe settings, it is not necessary to save changes until you are ready to exit the edit recipe screen.

9. Cook

Touch this icon to perform a test cook using the settings displayed on the screen.

NOTE: You may have to allow the oven time to cool down or warm up to the set temperature.

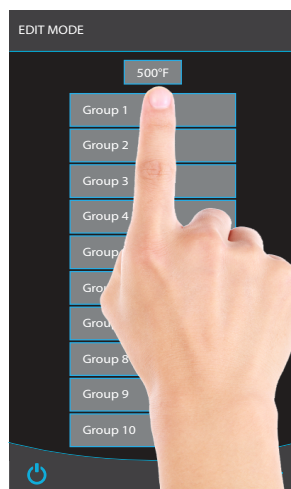

Figure 15: Edit Mode, Group Select

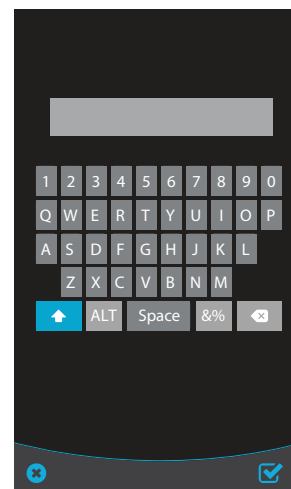

Figure 18: On-Screen Keyboard

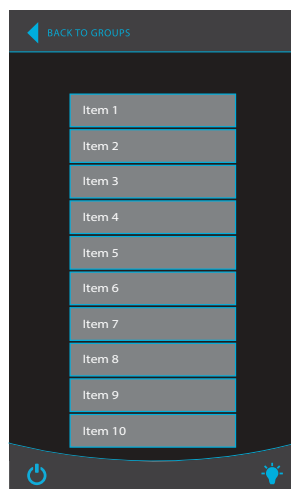

Figure 16: Edit Mode, Item Select

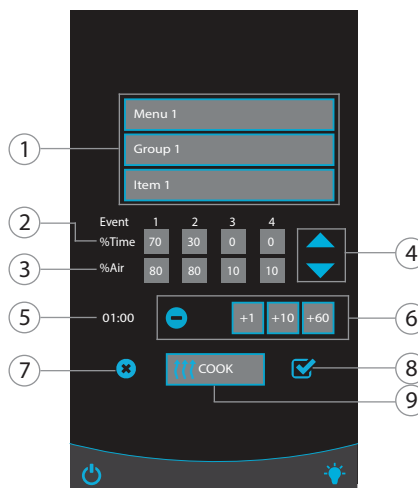

Figure 17: Edit Mode, Item Settings

Loading and Saving Menus

NOTE: To load or save a menu, you may need to verify that access to the Load Menu option is turned on. See page 14 for details.

When loading a menu from USB, the menu must be in the BIN (binary) format and the files must be loaded on the root of the USB.

To create a BIN (binary) formatted menu,

1. Using ChefComm, load or create the menu on your computer.
2. Select Oven > Data Transfer > Create Oven (BIN) File.
3. Navigate to where you wish to save the menu.

NOTE: If you are saving the menu to a USB drive and you will use that USB drive to load the menu to the oven, you must save the menu to the root (top level) of the USB drive.

4. Name the file.

NOTE: If your version of ChefComm Pro is lacking these features, contact TurboChef Customer Support to obtain an update.

To load a menu to the oven,

1. When the oven is off or cooling down, insert the USB drive (Figure 19). The oven will automatically detect the device.
2. Touch “Load Menu to Oven” to proceed.
3. If more than one menu is on the USB drive, you will be prompted to pick which menu to load.

To save a menu to a USB drive,

1. When the oven is off or cooling down, insert the USB drive (Figure 19). The oven will automatically detect the device.
2. Touch “Save Menu to USB” to proceed.

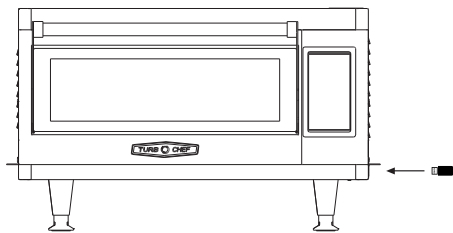



Figure 19: USB Port

Troubleshooting

The following is a list of fault codes and error messages, along with the possible problem(s) that the oven may experience. Please attempt the recommended action before calling Customer Support (800-908-8726, press 9 for service).

If any fault or error message occurs that is not listed below, contact Customer Support (800-908-8726, press 9 for service).

 **WARNING:** Food, oven doors, and oven cavities are hot! Use extreme caution when troubleshooting the issues below.

Issue	Possible Cause(s)	Resolution
No power to oven.	<ul style="list-style-type: none"> - Oven is not plugged in. - Main circuit breaker is tripped. 	<ul style="list-style-type: none"> - Plug the oven in. - Verify the wall circuit breaker is on. Reset the breaker, then power the oven back on.
Oven is not warming up properly.	<ul style="list-style-type: none"> - Oven is in the Off state. - Door is not closed. - Oven has been switched off at the main circuit breaker. - High-limit thermostat tripped 	<ul style="list-style-type: none"> - Touch “Menu” or the power icon. - Close the cook cavity door. - Turn the oven off and unplug the oven – leave for two minutes. Re-plug in the oven, switch on the isolator/main power supply, and touch “Menu.” - Press the button located on the oven rear wall (near the power cord) to reset the high-limit thermostat.
Display reads “Oven Door Open” and alarm sounds.	<ul style="list-style-type: none"> - Food obstruction preventing door from closing. - Oven door is open. - Door switches require adjustment. 	<ul style="list-style-type: none"> - Open the door and remove the obstruction. - Open and close the door several times. - Call Customer Support.
Oven is not cooking properly.	<ul style="list-style-type: none"> - Oven is not clean. - Incorrect group and/or item name was selected for the product. - Product was not cooked from correct starting state (for example, chilled or frozen). - Product out of specification. 	<ul style="list-style-type: none"> - Clean the oven following the cleaning instructions on pages 5-8. - Ensure the correct food group and/or item was selected. - Ensure the product was in the correct state before being placed in the oven. - Ensure the product is exactly the same weight/size as the typical product.

Issue	Possible Cause(s)	Resolution
Steam or smoke is present.	<ul style="list-style-type: none"> - Oven is not clean. - Rear filter is clogged. 	<ul style="list-style-type: none"> - Clean the oven following the cleaning instructions on pages 5-8. - Clean the air filter, (Step 8, Page 6).
Oven is cooling down, shutting down, or making selections on its own.	<ul style="list-style-type: none"> - Debris is on the display. - Display is experiencing interference. 	<ul style="list-style-type: none"> - Clean the display. - Call Customer Support.
F1: Blower Running Status Bad	<ul style="list-style-type: none"> - Oven power interrupted. 	<ul style="list-style-type: none"> - Verify the wall circuit breaker is on. Reset the breaker and then power the oven on. - Turn the oven off and unplug the oven – leave for two minutes. Re-plug in the oven, switch on the isolator/main power supply, and select “Menu” and then a set temperature.
F2: Cook Temperature Low	<ul style="list-style-type: none"> - Oven power interrupted. - Air nozzles on the top/bottom of the cook cavity are clogged. - Oven door is out of alignment. - Defective heater. - Blower motor not running. - Oven not fully warmed up. 	<ul style="list-style-type: none"> - Verify the wall circuit breaker is on. Reset the breaker and then power the oven on. - During daily cleaning, make sure to unclog the air nozzles on the top/ bottom of the cook cavity. - Call Customer Support. - Reset the high-limit thermostat located on the oven rear wall near the power cord. - Call Customer Support. - Repeat warmup and allow the oven to idle for five minutes.
F6: EC Temp	<ul style="list-style-type: none"> - Blockage of cool air into the oven. - Rear cooling fan exhaust guard(s) clogged. 	<ul style="list-style-type: none"> - Remove anything that may be obstructing the flow of cool air into the side/rear oven panels. - Make sure the rear fans are free of debris.

North America Limited Warranty

TurboChef Single Batch – North America

The TurboChef rapid cook oven Limited Warranty outlined below is activated upon shipment of your oven. Should you require additional assistance after reviewing the warranty outlined below, please call TurboChef Customer Support at 800.90TURBO.

Limited Warranty

TurboChef Technologies, Inc. (“TurboChef”) warrants to you, the purchaser, that under normal use the TurboChef rapid cook oven you have purchased (the “Equipment”) will be free from defects in material and workmanship during the Warranty Period, subject to the terms and conditions set forth herein. The “Warranty Period” is twelve (12) months from the date the Equipment is shipped from TurboChef’s U.S. factory or distribution center. This warranty is conditioned upon you promptly notifying TurboChef of any claims, as provided in the paragraph entitled “Warranty Claims” below, and providing TurboChef with all data and information requested by TurboChef or its service agents in connection with such claims as well as all necessary access to your premises and the Equipment. This warranty is made only to the initial purchaser of the Equipment from TurboChef or its authorized dealer; it is not assignable to subsequent purchasers unless TurboChef consents to such assignment in writing.

Disclaimer of Warranties

Except as provided in the Limited Warranty above, the Equipment is provided “as-is”. TurboChef disclaims all other warranties, express, statutory or implied, including without limitation, the implied warranties of title, non-infringement, merchantability and fitness for a particular purpose. TurboChef does not warrant that the Equipment will meet your specifications or needs. You acknowledge that you are solely responsible for the selection of the Equipment and determining the suitability of the Equipment for your needs.

Warranty Exclusions

Improper Installation, Operation or Maintenance: Equipment that is not installed, operated and maintained in accordance with TurboChef’s rapid cook oven owner’s manual (as may be updated by TurboChef from time to time, the “Manual”), a copy of which is provided to you with the Equipment or otherwise will be furnished to you upon request, is excluded from this warranty. This warranty does not apply to damage or failure which results, in TurboChef’s or its service agent’s sole opinion, from failure to provide a suitable installation and operating environment (including power and HVAC) and facilities as prescribed by the Manual, misuse, abuse, accident, neglect, power failure or power surges (over or under voltage), or to damage or failure from flood, fire, lightning or other natural or man-made disasters, or other Acts of God, or to Equipment that has missing or altered serial numbers.

Modifications and Repair: Equipment that has been modified or altered by persons other than TurboChef or its service agents, or Equipment that has had non-approved devices or connection items attached thereto, is excluded from coverage under this warranty. Repair of the Equipment by anyone other than TurboChef or its authorized service agents will void all warranties on the Equipment.

Accessories: Accessories and parts (collectively “Accessories”) that are consumed in the normal course of Equipment operation or maintenance are excluded from this warranty. Failure of or damage to Equipment or components from the use of non-approved cleaning chemicals, devices or processes is also excluded from this warranty. Accessories may include, but are not limited to, ceramic cooking platters, paddles and approved cleaning chemicals and devices.

Outstanding Invoices: If the full invoiced amount for Equipment purchased has not been paid within forty-five (45) days from the invoice date, then TurboChef will have no obligation to honor this or any other warranty on the Equipment until payment is received in full, including any accrued interest or other charges, has been satisfied, at which time warranty coverage will be reinstated, but the Warranty Period will not be extended.

Warranty Service, Exclusive Remedy

TurboChef will be solely responsible for determining whether or not the Equipment or any component thereof is defective. Defective components covered by this warranty will be repaired or replaced at TurboChef's option without charge to you and such repaired or replacement components will be covered by this warranty for the balance of the Warranty Period. Parts used in the repair of defective components and replacement components may be new, recovered or rebuilt. At its sole option, TurboChef may decide to replace defective Equipment covered by this warranty with new, recovered or rebuilt Equipment of equal or greater capability, and such Equipment will be covered by this Limited Warranty for the balance of the Warranty Period. Defective Equipment and components will become the property of TurboChef. This paragraph states TurboChef's sole and exclusive obligation and liability and your sole and exclusive remedy under this warranty. TurboChef shall not be responsible for a failure to provide warranty services due to causes beyond TurboChef's or its service agents' control.

Warranty Claims

Claims under this warranty must be reported to TurboChef during our normal working hours at 800.90TURBO, or such other reporting service as TurboChef may designate. Upon receipt of the claim and related information and preliminary verification that the claim is valid, TurboChef will promptly notify an authorized service agent to contact you and arrange for an on-site repair visit during the service agent's normal working hours. Any costs incurred by TurboChef or its service agent associated with a service agent being refused or unable to gain access to the Equipment on your premises, or a claim not covered by this warranty, will be charged to you.

Disclaimer of Damages

TurboChef disclaims all incidental, special and consequential damages, including but not limited to loss of use, lost revenue or profits, or substitute use, suffered by you or any third party, whether arising in contract, tort (including negligence), or otherwise, resulting from any breach by TurboChef or its service agents of this warranty, or resulting from the manufacture, use, or defects, of or in the Equipment, even if TurboChef was apprised of the possibility of such damages.

Customer Indemnity

You agree to indemnify, defend and hold TurboChef harmless from all third party claims, demands, judgments, fees and costs directly or indirectly arising out of or related to your use of the Equipment. You further agree to indemnify and hold TurboChef harmless from any incidental, consequential or special damages suffered by you, including lost revenue or profits, loss of use, or substitute use, during periods of Equipment failure or loss of use.

Territory

This warranty is valid in the United States of America, Canada and Puerto Rico.

Governing Law, Entire Warranty

This warranty shall be governed and construed in accordance with the laws of the State of Texas, USA (except with respect to its provisions regarding conflicts of laws). The warranty described herein is the complete and only warranty for Equipment and supersedes all prior oral or written agreements and understandings that may have existed between us relating to Equipment warranties. The terms of this warranty may not be altered, amended or modified except by a signed writing from TurboChef. Any purported alteration, amendment or modification by a service agent or anyone else will not be enforceable against TurboChef.

Charges for Non-Warranty Service or Rejection of Service Visit

In the event that repairs, replacement or service are provided by TurboChef's service agents for work not covered by this limited warranty, customer agrees to pay the service agent directly according to the service agent's normal scale of charges. In the event TurboChef is invoiced by the service agent for services not covered under this extended warranty, TurboChef will invoice customer and customer will pay such invoice based on terms of net 10 days. Customer also agrees to pay any cost incurred by TurboChef or its service agent associated with a service agent responding to a call for service, but then being refused or unable to gain access to the Oven on Customer's premises. Failure to submit payment may, at TurboChef's discretion, result in TurboChef voiding the balance of the warranty. In no event will TurboChef authorize service to a store with an outstanding Non-Warranty invoice.

International Limited Warranty

This Limited Warranty shall apply to the sales of all TurboChef Single Batch ovens (the “Equipment”) manufactured by TurboChef Technologies, Inc. (“TurboChef”), and sold to purchasers outside of the United States, Canada, Puerto Rico, Central and South America by an Authorized Distributor of TurboChef International (the “Authorized Distributor”).

Limited Warranty

You, the purchaser (“You”) have entered into a sales contract with the Authorized Distributor for the purchase of the Equipment. This Limited Warranty is made to you by the Authorized Distributor from whom you purchased the Equipment with the support of TurboChef. Subject to the limitations stated below, the Authorized Distributor warrants to You that the quantity and specification of the Equipment delivered to You shall be as set out in the Authorized Distributor’s acceptance of your order and that the Equipment will be free from any material defects in the product and workmanship for twelve (12) months from the date of installation (the “Warranty Period”), subject to the terms and conditions set forth herein.

Disclaimer

You acknowledge that You are solely responsible for the selection of the Equipment and determining the suitability of the Equipment for Your needs. All other warranties, conditions or terms relating to fitness for purpose, quality or condition of the Equipment, whether expressed or implied by statute or common law or otherwise are excluded to the fullest extent permitted by law.

The TurboChef Global Warranty System

This Limited Warranty commences upon delivery of the Equipment to Your premises. The Authorized Distributor will inspect and install the Equipment at Your premises in accordance with TurboChef’s instructions and will record the serial number of the Equipment, Your contact details, the date and location of installation and the results of the Authorized Distributor’s inspection. This information will be entered by the Authorized Distributor into the TurboChef global warranty system and will be used by TurboChef, the Authorized Distributor and its authorized service agents for the provision of the warranty service.

Warranty Service

During the Warranty Period, any materially defective Equipment will be repaired or replaced free of charge at TurboChef’s option provided that:

1. You notify the Authorized Distributor from whom You purchased the Equipment and/or TurboChef as soon as reasonably possible after discovery of a defect and in accordance with the warranty claims procedure set out below;
2. You provide the Authorized Distributor from whom You purchased the Equipment and/or TurboChef with all data and information reasonably requested by TurboChef, the Authorized Distributor or its authorized service agents in connection with Your warranty claim;
3. You make the Equipment available to TurboChef, the Authorized Distributor or its authorized service agents;
4. The Equipment has been installed by an Authorized Distributor and you have provided all necessary information for the Authorized Distributor to register the Equipment in the TurboChef global warranty system;
5. The Equipment has been operated and maintained by You in accordance with TurboChef’s “Owner’s Manual” provided with the Equipment (and as updated by TurboChef);

6. You have not used any non-approved devices, accessories, consumables or parts in conjunction with the Equipment; and
7. Repairs, modifications or alterations have not been attempted other than by TurboChef, an Authorized Distributor or its authorized service agent.

Neither TurboChef nor the Authorized Distributor assumes any liability for damage caused by Your failure to provide a suitable installation and operating environment (including power and HVAC) or facilities as prescribed by the Manual, misuse or abuse or by accident, neglect, power failure or power surges (over or under voltage) howsoever arising.

At its sole option, TurboChef may replace defective Equipment or components with new, recovered or rebuilt Equipment of equal or greater capability, and such Equipment or components will be warranted by the Authorized Distributor for the balance of the Warranty Period. Replaced defective Equipment or components will become the property of TurboChef.

Warranty Claims: Any warranty claim must be made directly in writing either to the Authorized Distributor from whom You purchased the Equipment or to TurboChef at the following address:

TurboChef Technologies, Inc.
2801 Trade Center Drive
Carrollton, Texas 75007
Phone: +1 214.379.6000
Fax: +1 214.379.6073

The claim must include the serial number of the Equipment and be received by TurboChef on or before the last day of the Warranty Period. Upon receipt of Your claim, TurboChef will promptly notify an Authorized Distributor or an authorized service agent to contact You, to verify Your claim and, if necessary, to arrange for an on-site repair visit during normal working hours.

Consumables and Parts Used with The Equipment: Neither TurboChef nor the Authorized Distributor assumes any liability for consumables and parts that are used in the normal course of Equipment operation or for failure of or damage to Equipment or components from the use of non-approved cleaning chemicals, devices or processes.

Charges for Service Not Covered by Limited Warranty: In the event that You request and receive repairs, replacement or service not covered by this Limited Warranty, You will be invoiced and must pay the Authorized Distributor or authorized service agent directly according to its normal scale of charges and business terms.

Product Liability: Neither TurboChef nor the Authorized Distributor assumes any liability for any incidental, special or consequential damages, including but not limited to loss of use, lost revenue or profits, or substitute use suffered by You or any third party, whether arising in contract, tort (including negligence), or otherwise resulting from any breach by TurboChef or the Authorized Distributor of the Limited Warranty provided herein.

Exclusive Remedy: This Limited Warranty states the Authorized Distributors and TurboChef's sole and exclusive obligation and liability and your sole and exclusive remedy under this Limited Warranty.

Third Party Rights: The UK Contract (Rights of Third Parties) Act 1999 is excluded from applying to this Limited Warranty and nothing herein confers or purports to confer on any third party any benefit or any right to enforce any term of this Limited Warranty.

Severability: If any item or provision contained in this Limited Warranty or any part of them (“an offending provision”) is declared to be or becomes unenforceable, invalid or illegal for any reason whatsoever in any jurisdiction, the other terms and provisions of this Limited Warranty shall remain in full force and effect in that jurisdiction as if it had been executed without the offending provision appearing in it and the entire Limited Warranty shall remain in full force and effect in all other jurisdictions.

Governing Law, Entire, Agreement: This Limited Warranty shall be governed by and construed according to English law. The application of the United Nations Convention on International Sale of Goods to this Limited Warranty is expressly excluded. This Limited Warranty may not be altered, amended or modified by the Authorized Distributor or its service agent, and no representation, alteration, amendment or modification by TurboChef shall be valid unless in a signed form from TurboChef.

For service or information call

800-908-8726

press 9 for service

or email

marineservice@turbochef.com



Part Number: DOC-1798 / Revision A / November 2019
Country Code: NA/EU

Global Operations

2801 Trade Center Drive
Carrollton, Texas 75007 USA
+1 214.379.6000 PHONE
+1 214.379.6073 FAX

Customer Support

800.90TURBO
+1 214.379.6000
turbochef.com