



JETAIR 28



Jet Air Convection Oven, Gas or Electric Dual Oven, Capacity (28) 18" x 26" Pans, Integrated Steam Injection (Shot & Pulse) System, Reversing 2-Speed Fan System, Delay Timer, Programmable Controls, Timer, Full View Glass Doors, Interior Light, Stainless Steel Construction, Casters, cETLus, NSF



PROJECT _____

ITEM NO. _____

NOTES _____

MODEL NUMBER: **JA28, JA28G**

FEATURES

- Advanced Programmable Controls
 - 99 Programmable Recipes
 - 8 Stage Baking
- Digital Temperature Control up to 500°F (260°C)
 - Fast Preheat (reaches temperature in 15 minutes)
- Digital Timer
- Jet Air Reversing Fan System with Variable Air Speeds & Fan Delay (some pan rotation required)
- Door Switch Cutoff for Fan Blower
- Shot & Pulse Steam Capabilities
- Available in Energy Efficient Gas or Electric
- USB Port for Uploading & Downloading Recipes



CONSTRUCTION

- Stainless Steel Construction
- Full View Heat Reflective Thermal Glass Doors with Magnetic Latches
- Brightly Lit Interior
- Fully Insulated and Completely Sealed
- Four Swivel Casters (2 locking)

CLEARANCES

Minimum Clearance from Combustible Materials:

- 1" (25mm) Sides & Back
- 4" (102mm) on Non-Combustible Floor
- 12" (305mm) Top

OPTIONS & ACCESSORIES

- Water Filter (PLF240) [Recommended]
- High Temperature Gasket (HTG001) [Recommended for Temperatures above 400°F/205°C]
- Gas Quick Disconnect Kit: 4' (1200mm); includes flexible hose, ball and securing device (GAH700)
- Perforated Nickel Plated Pizza Decks (GRPIZ6)

WARRANTY

- One Year Labor & Two Year Part

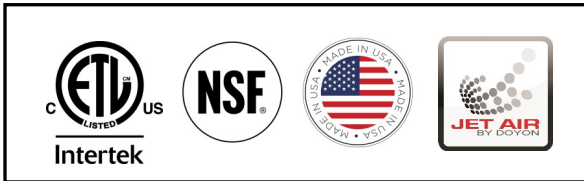

Model	Crated Weight	Overall Dimensions			Interior Dimensions			Pan Capacity (18"x26")	Shelf Spacing
		W	D	H	W	D	H		
JA28	1975 (897)	72" (1829)	49 1/4" (1251)	73" (1854)	25 1/2" (648)	30 1/2" (775)	28" (711)	28	3 1/4" (83)
JA28G	2335 (1060)	72" (1829)	53 3/8" (1362)	73" (1854)	25 1/2" (648)	30 1/2" (775)	28" (711)	28	3 1/4" (83)

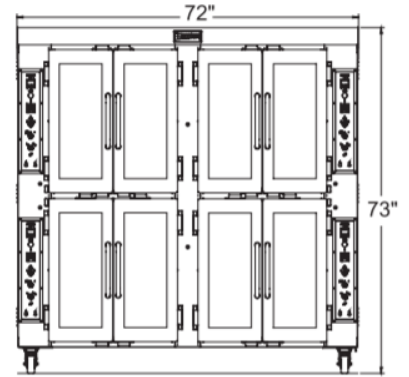
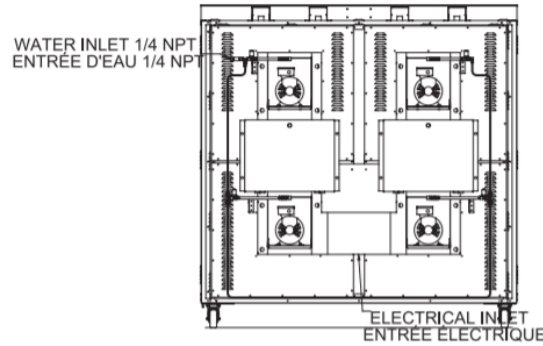
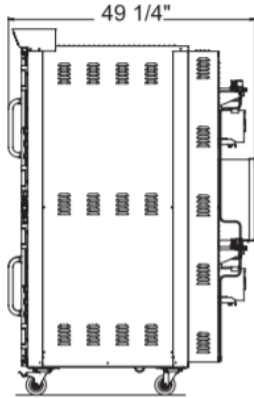
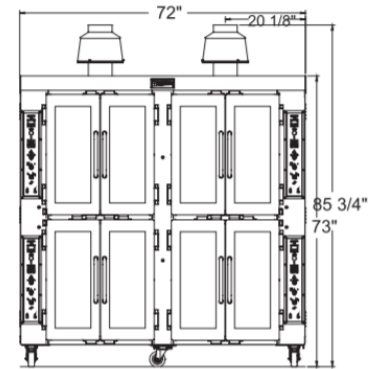
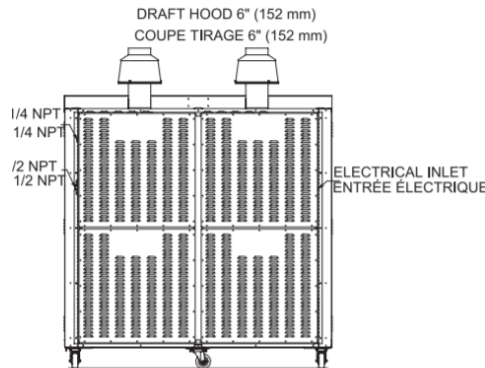
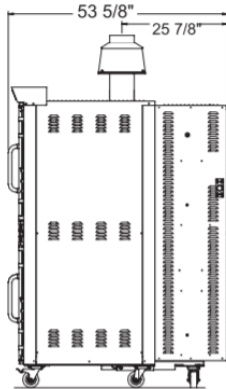

DRAWINGS
JA28

JA28G

JA28 ELECTRICAL SYSTEMS DATA

Model	Electrical System *ground wire not included					
	Volts	Phases	Amps	kW	Wires*	Hz
JA28	208	1/3	208/119	43	2/3	60
	240	1/3	180/105	43	2/3	

JA28G GAS & ELECTRICAL SYSTEMS DATA

Model	Gas System			Water Inlet	Electrical System *ground wire not included					
	BTU	D.H.	G.I.		Volts	Phases	Amps	kW	Wires*	Hz
JA28G	260,000	2x6"	3/4"	1/4"	208	1	18	4	2	60
		(2x152)	(13)	(6)	240	1	18	4	2	

Recommended Gas Pressure | Propane Gas: 11" W.C. Natural Gas: 7" W.C.
