



IM-1700/2000 Modular Cube Ice Machine

Models

- IM-1700-AC IM-1700-AH IM-1700-WC IM-1700-WH IM-1700-RC IM-1700-RH
 IM-2000-AC IM-2000-AH IM-2000-WC IM-2000-WH IM-2000-RC IM-2000-RH



ICETRO IM-1700/2000 ice machine on a IB-085-48 bin
*Ice Machine and Bin sold separately

- IM-1700: Up to 1,722 lbs. production per 24 hours
- IM-2000: Up to 2,032 lbs. production per 24 hours
- 304 stainless-steel exterior (durable & rust-resistant)
- Simple diagnostic panel to assist service & maintenance
- Cleaning switch for auto cleaning cycle
- Magnetic & cleanable condenser air filter
- Adjustable flush time to reduce scale & cleaning cost
- ABS antimicrobial interior to reduce slime & cleaning cost
- Water distributor tube & water sump removed w/o tools
- Heavy duty water curtain, pins & hangers for easy removal
- Hinged front doors for easy access
- Split front panel requires less space to access food zone
- Side panel screws easily removed from front of machine
- Louvers on both sides for optimal ventilation
- Improved evaporator section to reduce airborne bacteria
- R-410A refrigerant

Ice Types



Half Cube
3/8" x 1 1/8" x 7/8"
(.95 x 2.86 x 2.22 cm)



Cube
7/8" x 7/8" x 7/8"
(2.22 x 2.22 x 2.22 cm)

Factory Warranty

Parts & Labor Parts
3 YR **5** YR **5** YR
 Ice Maker Evaporator Compressor



Extend ice machine warranty 1 year by installing an IcePro 2500 with ice machine.

* Applies only to new ice machines, at the time of original installation & start-up.

Specifications

BTU Per Hour: 26,910
Refrigerant: R410A

- Ambient Temperature Range: 50° to 100°F (10° to 37°C)
- Ambient Temperature Range for remote condenser IRC-2000: -5° to 117°F (-20° to 47°C)
- Water Temperature Range: 50° to 90°F (10° to 32°C)
- Potable Water Pressure: Min. 20 psi (137.9 kPa) Max. 80 psi (551.1 kPa)
- Condenser Water Pressure: Min. 20 psi (1.38 bar) Max. 150 psi (10.34 bar)

Ice Machine Electric

208-230V/60Hz/1ph

Minimum circuit ampacity:

Air-cooled: 19.7 1ph
Water-cooled: 19.7 1ph
Remote: 19.7 1ph

Maximum fuse size:

Air-cooled: 30 1ph
Water-cooled: 30 1ph
Remote: 30 1ph

Accessories

Refrigeration Line Sets

IRT-20R410 20' line set
IRT-35R410 35' line set
IRT-50R410 50' line set



Remote Condenser IRC-2000

(sold separately for RC/RH models)



Bin-Stat Kit IBO-150KIT

Recommended when ice machine is installed on soda dispenser.



Water Filtration IcePro 2500

Reduces sediment and chlorine contaminants with the use of Citrine.





IM-1700/2000 Ice Cube Machine

PLAN VIEW IM-1700/2000-AC/AH (MACHINE HEAD)

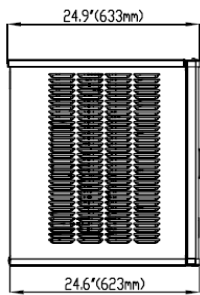

SIDE VIEW

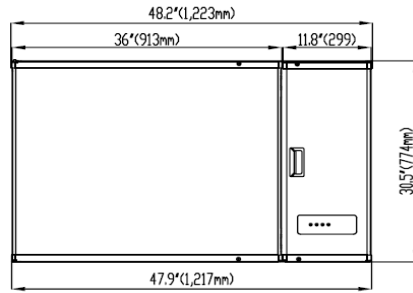

FRONT VIEW

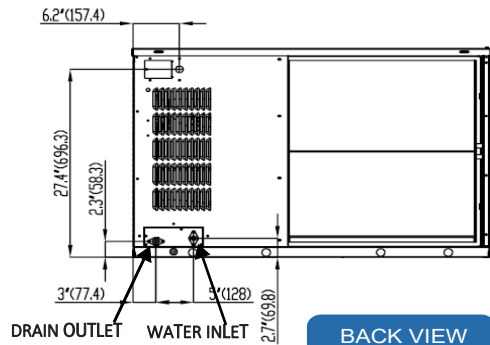

BACK VIEW

PLAN VIEW IM-1700/2000-WC/WH (MACHINE HEAD)

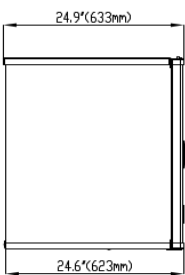

SIDE VIEW

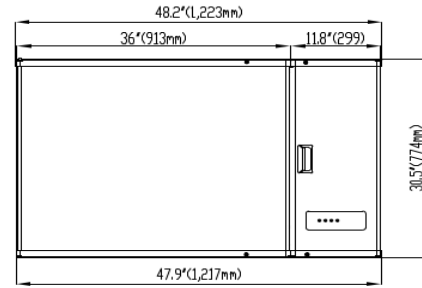

FRONT VIEW

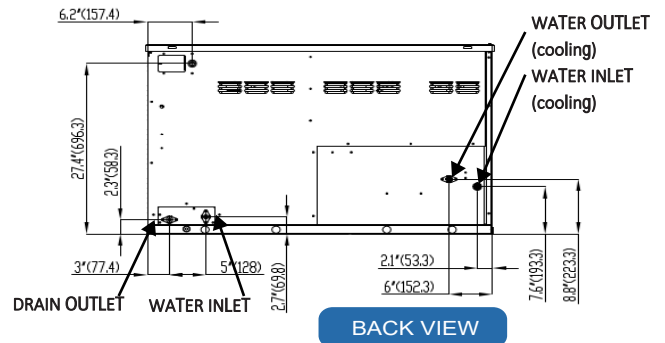

BACK VIEW

PLAN VIEW IM-1700/2000-RC/RH

(IRC-2000 condenser, back view [side and front same as AC/AH])

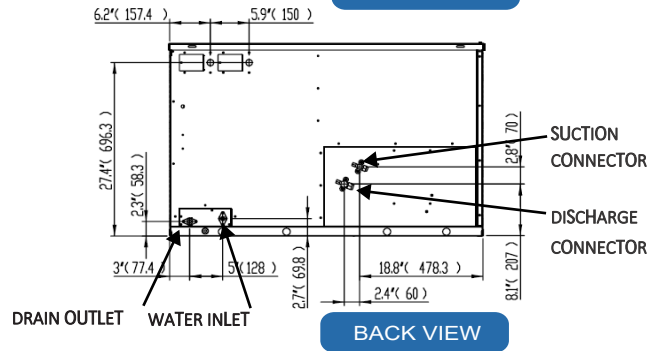
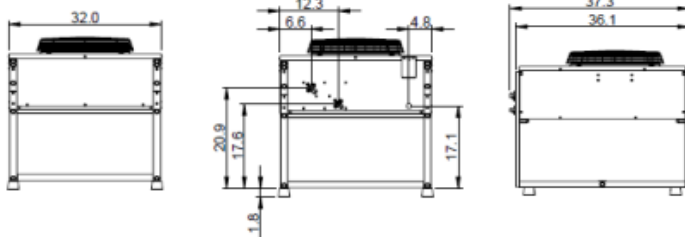

BACK VIEW

Specifications

	Width	Depth	Height	Electrical		
Machine Dimensions	48"	24.5"	30.4"	208-230 V	60 Hz	1 phase
R. Condenser Dims.	37.3"	32"	27.1"	120 V	60 Hz	1 phase

Specification	Cooling Type	Ice Production		kWh / 100 lbs.	Potable Water / 100 lbs. Ice	Heat Rejection / Hour	Ship Wt.	Net Wt.
		24 hrs., 70°F air / 50°F water	24 hrs., 90°F air / 70°F water					
Units	A/W/R	lbs.	lbs.	kWh	Gal.	BTU	lbs.	lbs.
IM-1700-AC/AH	Air	1722	1446	4.66	14	26,135	440	322
IM-2000-AC/AH	Air	2032	1708	4.24	14	34,644	440	322
IM-1700-WC/WH	Water	1843	1678	2.95	14	23,127	430	311
IM-2000-WC/WH	Water	2006	1821	3.51	14	32,988	430	311
IM-1700-RC/RH	Remote	1680	1462	4.44	14	26,910	440	322
IM-2000-RC/RH	Remote	1980	1730	4.04	14	35,311	440	322
IRC-2000	Remote	N/A	N/A	N/A	N/A	(see R units)	195	143

