



DESIGNED SMART. BUILT SOLID.®

INSTALLATION AND OPERATING INSTRUCTIONS

Energy Saving Toaster Model: ECO-4000 (300E, 300L, 500E, 500L)

INTENDED FOR OTHER THAN HOUSEHOLD USE



WARNING: California Residents Only. This product can expose you to chemicals including chromium which is known to the State of California to cause cancer and birth defects or other reproductive harm. For more information go to www.P65Warnings.ca.gov.



FOR YOUR SAFETY: Do not store or use gasoline or other flammable vapors and liquids in the vicinity of this or any other appliance.



WARNING: Improper installation, operation, service or maintenance can cause property damage, injury or death. Read and understand these instructions thoroughly before positioning, installing, maintaining or servicing this equipment.



APW Wyott® cooking equipment has been engineered to provide you with year-round dependable service when used according to the instructions in this manual and standard commercial kitchen practices.



2M-8898810 REV C (03-22)

APW Wyott Food Service Equipment Company
265 Hobson St. • Smithville, TN 37166

TABLE OF CONTENTS

SECTION	ITEM	PAGE	SECTION	ITEM	PAGE
1	Owner’s Information	2	7	Cleaning	5
2	Safety Information	2	8	Troubleshooting	5
3	Safety Signs and Messages	3	9	Preventative Maintenance	6
4	Specifications	3	10	Wiring Diagrams	6
5	Installation Instructions	3	11	Parts Lists & Exploded Views	7
6	Operation	4	12	Warranty	13

1. OWNER’S INFORMATION

General Information

1. Always clean equipment thoroughly before first use. (See general cleaning instructions).
2. Check rating label for your model designation and electrical rating.
3. For best results, use stainless steel counter tops.

General Operation Instructions:

1. All food-service equipment should be operated by trained personnel.
2. Do not allow your customers to come in contact with any surface labeled “CAUTION HOT”.
3. Never touch quartz or steel heaters.

Warranty Information:

Reliability Backed By APW Wyott’s Warranty:

All APW Wyott® Toaster Ovens are backed by a one year parts and labor warranty, including On-Site Service calls within 50 miles of authorized service technicians.

Service Information:

Service Hotline (800) 733-2203

2. SAFETY INFORMATION









APW Wyott takes pride in the design and quality of our products. When used as intended and with proper care and maintenance, you will experience years of reliable operation from this equipment. To ensure best results, it is important that you read and follow the instructions in this manual carefully.

Installation and start-up should be performed by a qualified installer who thoroughly read, understands and follows these instruction.

If you have questions concerning the installation, operation, maintenance or service of this product, contact APW Wyott Foodservice Equipment Company’s “ Technical Service Department”.

The following words and symbols, found in this manual, alert you to hazards to the operator, service personnel or the equipment. The words are defined as follows:

3. SAFETY SIGNS AND MESSAGES

	DANGER: This symbol warns of imminent hazard which will result in serious injury or death.	
	WARNING: This symbol refers to a potential hazard or unsafe practice, which could result in serious injury or death.	
	CAUTION: This symbol refers to a potential hazard or unsafe practice, which may result in or moderate injury or product or property damage	
	NOTICE: This symbol refers to information that needs special attention or must be fully understood even though not dangerous.	

4. SPECIFICATIONS

ECO 4000 (OR QST) MODEL	VOLTS	WATTS	PH
ECO 4000 -350L	120	1700	1
ECO 4000 -500L	208	2800	1
ECO 4000 -500L	240	2800	1

Power Cord:

Six (6) foot, 3 wire grounded cord. If the supply cord is damaged, the manufacturer, or an authorized service agent, must replace it in order to avoid a hazard and warranty. Please contact the factory by calling the 800 # located on the unit.



Shipping Weight:

ECO 4000-350L – 54 Lbs (24.5 kg)

ECO 4000-500L – 54 Lbs (24.5 kg)



5. INSTALLATION INSTRUCTIONS



If the carton appears damaged, or damage is discovered once the carton is opened, stop immediately and contact the freight company to file a damage claim.



	CAUTION: The ECO TOASTER Oven is shipped assembled except for installation of the crumb tray assembly. Please remove all supports and packaging materials before operating the unit. Failure to remove all packaging materials may lead to a fire and / or damage to the appliance.	
---	--	---



1. Remove all external packaging that is protecting top portion of unit.
2. Remove unit from shipping container while in the upright position. The unit can be lifted out of the carton by grasping under the back side and the conveyor of the appliance. Please remove the plastic bag.
3. Remove all internal packaging to the unit, if present.
4. Visually inspect all external and internal portions of unit for damage. Important: Inspect the Quartz elements located inside the oven tunnel after removal of packing material. To inspect the quartz elements, use a small mirror held under and over each element to detect cracks. Important: The quartz elements are fragile and will break under stress. Do not twist, pull, push, or otherwise subject the quartz elements to stress.

- Wipe down the exterior of the unit using a damp cloth with warm water. Do not use abrasive pads or cleaners as they will damage the stainless steel surface.



 Note: do not use cleaners of any kind on the quartz heaters. 

 Note: Ambient Conditions - Make sure that the operating location is in an area where the ambient temperature is held constant (minimum 70°F). Please avoid areas such as near exhaust fans and air conditioning ducts. 

 Warning: Ensure that operation location is at a reasonable distance from combustible walls and materials otherwise combustion or discoloration could occur. Do not cover the rear inlets or the side inlets and outlets. Restricting or covering the air inlets and outlets may cause the unit to overheat and WILL void your warranty. 

 Caution: Place unit on a stable, level counter at a convenient height for use. Turn the adjustable feet so that unit is level to counter top. The top of the unit is not intended for use as a shelf. Materials placed there are at risk for fire. 

- Before plugging unit into wall, make sure that the power switch located on the back of "E" models and on the Front of the "L" model is in the off position.
- Warning! Ensure no hands, tools or parts or other unintended items are located on the conveyor as injury will result when unit is turned on.
- Plug unit into grounded electrical outlet with correct voltage, and plug configuration.

 Warning! Using any receptacle that is not designed to match the attached cord and plug MAY cause personal injury and WILL void your warranty. Please attach the ECO-4000, to an individual branch circuit. 

6. OPERATION

- The controls that operate the belt conveyor speed and the heaters are located on the front of the unit.
- The On/Off switch is used to turn the unit on or off. Once the unit is turned on the conveyor will automatically run. Warning: Ensure no hands, tools or parts are located on the conveyor as injury will result when unit is turned on.
- Note: Before moving the On / Off switch to the "On" position, please read the following statements:
- A. CAUTION! HOT SURFACES! The exterior metal surfaces of the unit will get hot enough to cause burns. Avoid touching these surfaces to prevent injury.
B. WARNING! SEVERE BURN HAZARD QUARTZ HEATERS. The quartz heaters or metal heaters located in the top of the unit operate at very high temperatures. DO NOT TOUCH HEATERS AFTER UNIT IS TURNED ON.
- This oven has 2 heating zones, 1 above the conveyor, and one beneath the conveyor.

Operation Instructions for 350L and 500L

- Turn the Power Switch on located on the rear of the unit. When the unit is "ON", the conveyor belt will move.
- Use the "TOP HEAT" and "BOTTOM HEAT" knobs to adjust to the desired temperature and achieve the toasting pattern. Knobs can be turned to an "OFF" position, turning off the heat in a full run mode. In "E-SAVE" mode, the elements (even if "OFF") will cycle to keep cavity temperature up.
- Use the conveyor speed control to get the desired toast quality – "DARK" will run the conveyor slower and "LIGHT" will run the conveyor faster.

7. CLEANING

Insure the appliance has been turned off and has had sufficient time for all surfaces to cool down before cleaning. Use only mild soap and water to clean this appliance. Appliance cleaning should be performed daily.

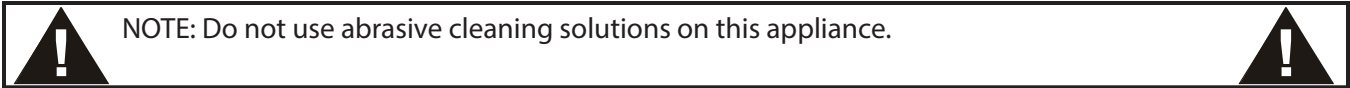

Daily Cleaning

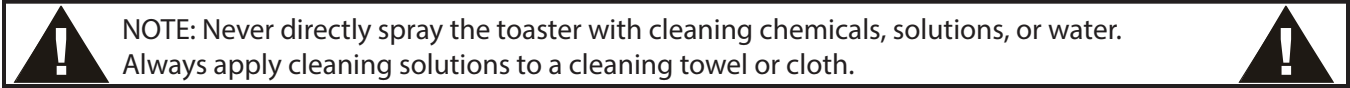

- Remove the crumb pans and wipe out debris with a damp rag and mild soap solution.
- Using a damp rag with mild soap and water, wipe down the exterior surfaces of the appliance.
- Using a damp rag with mild soap solution, wipe down all areas of the conveyor. Do not attempt to clean the quartz or metal heaters.
- When units are in the stacked configuration, it is still necessary to clean between the units. Using a damp rag with mild soap and water, wipe down the tops and undersides of all units. Ensure there are no foreign objects between the units that could catch fire.
- Using a damp rag with mild soap and water, wipe the surfaces of the stacking spacers on all four corners.

8. TROUBLESHOOTING

Always ask and check the following:

Not getting power:

1. Is the unit connected to a live power source of the proper voltage?
2. Check the rating label. Is the unit connected to the correct power source?
3. Check the circuit breaker.
4. Is power switch "ON"?
5. If the above checks out, and you still have problems, call your local service agent.

Conveyor not working:

1. Please refer to "Not getting power" section.
2. Check belt for obstructions. Belt may be jammed.
3. Note: At slower settings the conveyor moves very slow and may appear stalled, which is not the case.
4. If the above checks out, and you still have problems, call your local service agent.

Food not cooking properly:

1. Please refer to "Not getting power" section.
2. Is the controller and speed control adjusted to the desired setting? (See Product Key Programming section to check button parameters)
3. If the above checks out, and you still have problems, call your local service agent.

9. PREVENTATIVE MAINTENANCE SCHEDULE

- Please follow the cleaning section for the daily preventative maintenance schedule.

!
!
Note: Do not use abrasives or cleaning solutions on this appliance.

- Routinely check before every operation that adequate distance is allowed between fans and anything that would possibly allow foreign debris or substances to be taken in by inlet fan.
- Clean fan guards on a daily basis to ensure proper inlet cooling to electrical components and efficient hot air exhaust.
- On a daily basis make sure side walls of tunnel oven remain clean to assist in maintaining even cooking around product. Be careful not to bump or hit the quartz or metal heaters when wiping down.
- Ensure belt is properly tensioned as to prevent slippage or binding, which causes strain on motor.

!
!
Note: Do not attempt to maintenance, service, or clean the quartz or metal heaters.

10. WIRING DIAGRAM

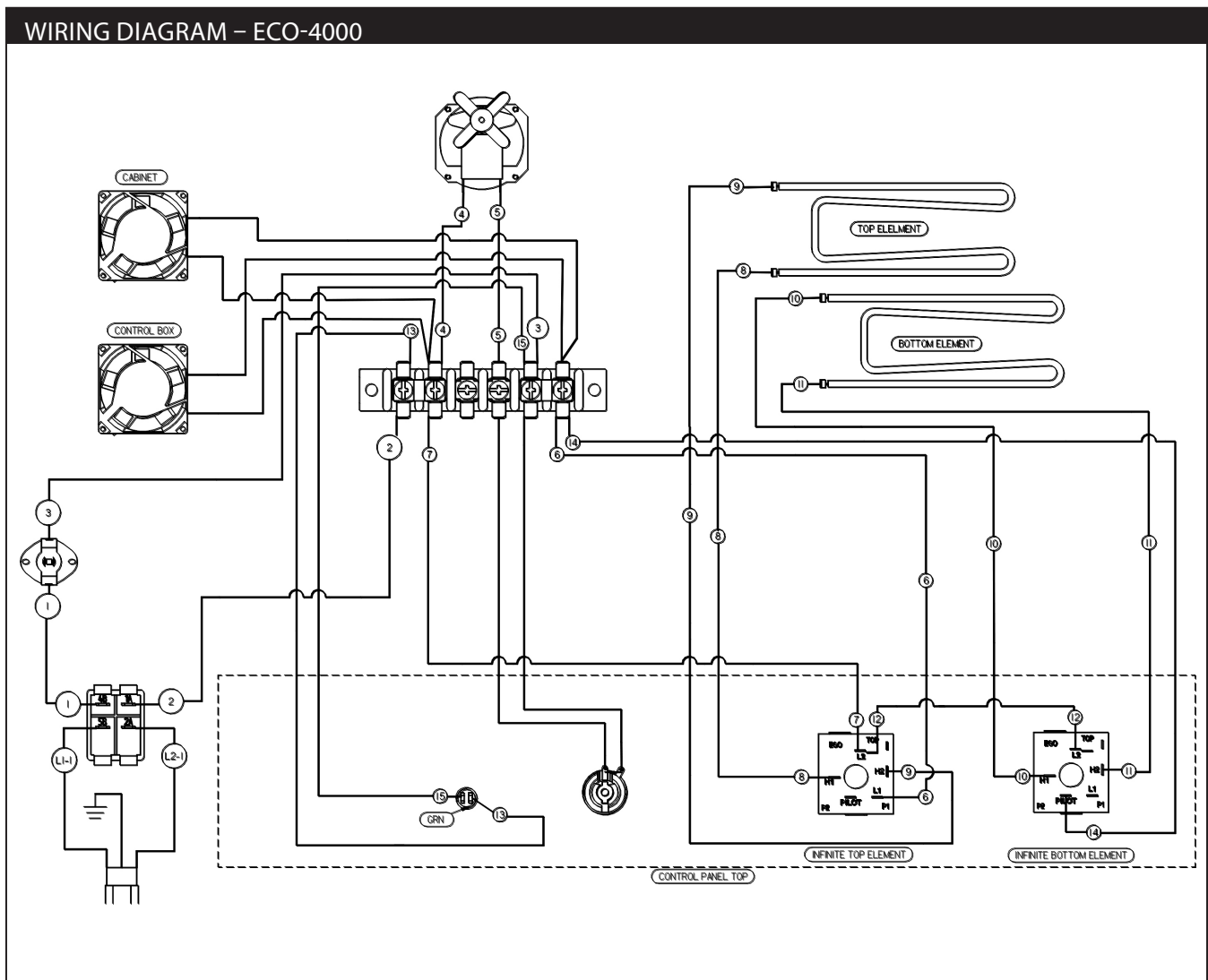

11. EXPLODED VIEW AND PARTS LIST

EXPLODED VIEW – ECO-4000

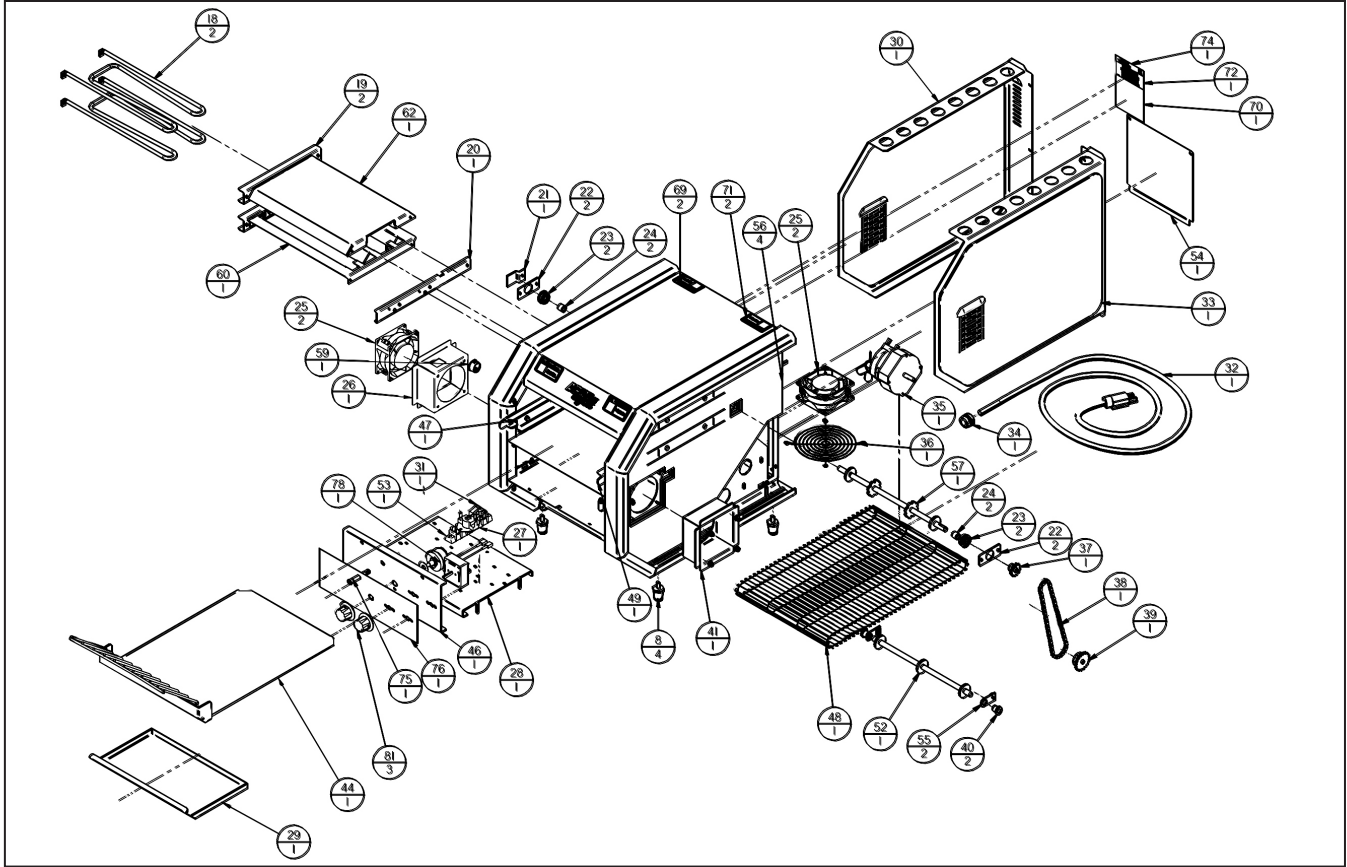

PARTS LIST – ECO-4000 350L

Item	P/N	Qty	Description
1	21851423	1	PANEL,CTRL BOX TOP ECO
2	21851425	1	PANEL,CTRL BOX BTM BCK ECO
3	21851427	1	HOUSING, END LS ECO
4	21851426	1	HOUSING, END RS ECO
5	21851476	2	RETAINER, PANEL SIDE ECO
6	21851475	2	RETAINER, PANEL FRONT ECO
7	8353200	4	RIVNUT, 1/4-20 THIN HEAD
8	86621-00	4	LEG 1" CHROME
9	8353600	14	RIVET, POP 3/16 FLUSH BREAK
10	21851432	1	BASE, BOTTOM FRONT ECO
11	21851424	1	SLIDE, TOAST ECO
12	21851428	1	PANEL, TOP ECO
13	8460900	2	NUT, PUSH 1/8"
14	2065847	1	LOGO, APW Wyott CASTED
15	21851433	1	PANEL, TOP INNER ECO
16	21851434	1	PANEL, BACK (E) ECO
17	8353000	61	POP RIVET
18	93300017	2	ELEMENT, 120V 832W
19	21851453	2	BRACKET, ELEMENT CART. MOUNTING (L) ECO
20	21851477	1	BRACKET, MOUNTING RTD ECO

PARTS LIST – ECO-4000 350L

Item	P/N	Qty	Description
21	21851442	1	RETAINER, SHAFT
22	21851443	2	BRACKET, BEARING ECO
23	48324800	2	BEARING, SHAFT
24	48386800	2	SPACER, CONVEYOR SHAFT
25	784680	2	FAN, AXIAL
26	21851473	1	DUCT, FAN ECO
27	1377000	1	HIGH LIMIT RESETTABLE OPEN @180
28	21851459	1	BASE, COMPONENT MOUNTING ECO
29	21851460	1	DRAWER, HOLDING ECO
30	21851438	1	PANEL, SIDE LEFT ECO
31	1305612	1	SWITCH, ROCKER 20 AMP
32*	1536500	1	CORDSET 12-3 SJTOW 5-20P 72"L
33	21851437	1	PANEL, SIDE RIGHT ECO
34	89111	1	STRAIN RELIEF
35	48515200	1	MOTOR, GEAR 115V 60HZ
36	31007-33	1	GUARD, FAN FINGER
37	48326100	1	SPROCKET, 12 TOOTH 1/4 PITCH 3/8 BORE
38	48290100	1	CHAIN DRIVE 1/4 PITCH X 68
39	48326000	1	SPROCKET, 18 TOOTH 1/4 PITCH 5/16 BORE
40	43812500	2	BEARING FLANGED POLYMER
41	21851463	1	DUCT, AIR ECO
42	21851472	1	SIDE, RIGHT (L) QST
43	21851478	1	SIDE, LEFT (L) QST
44	21851439	1	TRAY CRUMB
45	21851431	1	BASE, BOTTOM BACK ECO
46	21851444	1	PANEL, CONTROL ECO VL
47	21851458	1	SIDE, CONVEYOR LS ECO
48	48292000	1	BELT, WIRE 27x.05 3 SEG.
49	21851457	1	SIDE, CONVEYOR RS ECO
50*	21851479	1	CORD, FAN HARNNESS
51*	8408300	44	#8-32 HEX NUT, KEPS, NI
52	43812200	1	SHAFT & IDLER WHEEL W/ASSY
53	1107200	1	BLOCK TERINAL, 6 STATION 600V
54	21851451	1	COVER, ACCESS BACK ECO
55	21851441	2	CLIP BEARING ECO
56	21851468	4	INSULATION, ECO TOASTER (E)
57	48395600	1	DRIVE SHAFT ASSY SEGMENTED BELT
58*	8113910	8	SCREW, MACH. PAN HD. PH. 8-32 X 1-3/4 S/S
59	89784-00	1	BUSHING, 7/8 SNAP, HEYCO
60	21851456	1	TRAY, ELEMENT BOTTOM (L) QST
61*	8130000	13	8-32 X 3/8 TYPE T
62	21851465	1	TRAY, ELEMENT TOP (L) QST
63*	8134900	6	8-32 X 3/8 TR HD
64*	8503000	2	WASHER, FLAT #8
65*	8400100	8	NUT, HEX KEPS, #6-32
66*	21851420	2	SPACER, NYLON
67*	81108-00	2	M/S TR HD PH 6-32x1"

PARTS LIST – ECO-4000 350L

Item	P/N	Qty	Description
68*	770174	4	SCREW, MACHINE TR HD PH #10-24 X 3/4 SS
69	43813103	2	LABEL, WRNG, HOT SURFC
70	8861000	1	LABEL, SPEC
71	43813149	2	LABEL, WRN HOT SURF (FRNCH)
72	8837002	1	LABEL, DISCONNECT POWER
73*	21851492	1	HARNESS, WIRING ECO L
74	8832600	1	LABEL, SERVICE HOTLINE
75	21851485	1	LIGHT, INDICATOR GREEN
76	21851484	1	DECAL ECO (L)
77*	8105800	6	SCREW, PH, 6-32x3/8, S/S
78	48322150	1	RHEOSTAT, 120V w/TERMINALS
79*	8511900	1	WASHER, FLAT 3/8
80*	13279-00	2	SWITCH INFINITE
81*	781189	3	ZYTRON KNOB
82*	21851499	1	COVER, INSUL.TOP & BCK ECO
83*	21851487	2	INSULATION, CTRL BOX TOP & BACK
84*	21851488	2	INSULATION, CTRL BOX BOTTOM
85*	21851489	1	INSUALTION, SIDE PANEL LS
86*	21851409	1	COVER, CONTROL ECO-4000 HILTON

PARTS LIST – ECO-4000 500L

Item	P/N	Qty	Description
1	21851423	1	PANEL,CTRL BOX TOP ECO
2	21851425	1	PANEL,CTRL BOX BTM BCK ECO
3	21851427	1	HOUSING, END LS ECO
4	21851426	1	HOUSING, END RS ECO
5	21851476	2	RETAINER, PANEL SIDE ECO
6	21851475	2	RETAINER, PANEL FRONT ECO
7	8353200	4	RIVNUT, 1/4-20 THIN HEAD
8	86621-00	4	LEG 1" CHROME
9	8353600	14	RIVET, POP 3/16 FLUSH BREAK
10	21851432	1	BASE, BOTTOM FRONT ECO
11	21851424	1	SLIDE, TOAST ECO
12	21851428	1	PANEL, TOP ECO
13	8460900	2	NUT, PUSH 1/8"
14	2065847	1	LOGO, APW Wyott CASTED
15	21851433	1	PANEL, TOP INNER ECO
16	21851434	1	PANEL, BACK (E) ECO
17	8353000	61	POP RIVET
18	21851481	2	ELEMENT, 1400W @ 240V
19	21851453	2	BRACKET, ELEMENT CART. MOUNTING (L) ECO
20	21851477	1	BRACKET, MOUNTING RTD ECO
21	21851442	1	RETAINER, SHAFT

PARTS LIST – ECO-4000 500L

Item	P/N	Qty	Description
22	21851443	2	BRACKET, BEARING ECO
23	48324800	2	BEARING, SHAFT
24	48386800	2	SPACER, CONVEYOR SHAFT
25	784682	2	FAN, AXIAL 230V
26	21851473	1	DUCT, FAN ECO
27	1377000	1	HIGH LIMIT RESETTABLE OPEN @180
28	21851459	1	BASE, COMPONENT MOUNTING ECO
29	21851460	1	DRAWER, HOLDING ECO
30	21851438	1	PANEL, SIDE LEFT ECO
31	1305612	1	SWITCH, ROCKER 20 AMP
32*	15346-00	1	CORD, 14/3 HSJO NEMA 6-20P 72"
33	21851437	1	PANEL, SIDE RIGHT ECO
34	89792-00	1	STRAIN RELIEF
35	48514300	1	MOTOR, GEAR 230V 60HZ 9RPM
36	31007-33	1	GUARD, FAN FINGER
37	48326100	1	SPROCKET, 12 TOOTH 1/4 PITCH 3/8 BORE
38	48290100	1	CHAIN DRIVE 1/4 PITCH X 68
39	48326000	1	SPROCKET, 18 TOOTH 1/4 PITCH 5/16 BORE
40	43812500	2	BEARING FLANGED POLYMER
41	21851463	1	DUCT, AIR ECO
42	21851472	1	SIDE, RIGHT (L) QST
43	21851478	1	SIDE, LEFT (L) QST
44	21851439	1	TRAY CRUMB
45	21851431	1	BASE, BOTTOM BACK ECO
46	21851444	1	PANEL, CONTROL ECO VL
47	21851458	1	SIDE, CONVEYOR LS ECO
48	48292000	1	BELT, WIRE 27x.05 3 SEG.
49	21851457	1	SIDE, CONVEYOR RS ECO
50*	21851479	1	CORD, FAN HARNNESS
51*	8408300	44	#8-32 HEX NUT, KEPS, NI
52	43812200	1	SHAFT & IDLER WHEEL W/ASSY
53	1107200	1	BLOCK TERMINAL, 6 STATION 600V
54	21851451	1	COVER, ACCESS BACK ECO
55	21851441	2	CLIP BEARING ECO
56	21851468	4	INSULATION, ECO TOASTER (E)
57	48395600	1	DRIVE SHAFT ASSY SEGMENTED BELT
58*	8113910	8	SCREW, MACH. PAN HD. PH. 8-32 X 1-3/4 S/S
59	89784-00	1	BUSHING, 7/8 SNAP, HEYCO
60	21851456	1	TRAY, ELEMENT BOTTOM (L) QST
61*	8130000	13	8-32 X 3/8 TYPE T
62	21851465	1	TRAY, ELEMENT TOP (L) QST
63*	8134900	6	8-32 X 3/8 TR HD
64*	8503000	2	WASHER, FLAT #8
65*	8400100	8	NUT, HEX KEPS, #6-32
66*	21851420	2	SPACER, NYLON
67*	81108-00	2	M/S TR HD PH 6-32x1"
68*	770174	4	SCREW, MACHINE TR HD PH #10-24 X 3/4 SS

PARTS LIST – ECO-4000 500L

Item	P/N	Qty	Description
69	43813103	2	LABEL, WRNG, HOT SURFC
70	8861000	1	LABEL, SPEC
71	43813149	2	LABEL, WRN HOT SURF (FRNCH)
72	8837002	1	LABEL, DISCONNECT POWER
73*	21851492	1	HARNESS, WIRING ECO L
74	8832600	1	LABEL, SERVICE HOTLINE
75	21851485	1	LIGHT, INDICATOR GREEN
76	21851484	1	DECAL ECO (L)
77*	8105800	6	SCREW, PH, 6-32x3/8, S/S
78	48322250	1	RHEOSTAT, 208/240V w/TERMINALS
79*	8511900	1	WASHER, FLAT 3/8
80*	13279-00	2	SWITCH INFINITE
81*	781189	3	ZYTRON KNOB
82*	21851499	1	COVER, INSUL.TOP & BCK ECO
83*	21851487	2	INSULATION, CTRL BOX TOP & BACK
84*	21851488	2	INSULATION, CTRL BOX BOTTOM
85*	21851489	1	INSUALTION, SIDE PANEL LS
86*	21851409	1	COVER, CONTROL ECO-4000 HILTON

LIMITED EQUIPMENT WARRANTY

APW warrants to the original purchaser of new APW's products to be free from defects in material or workmanship, under normal and proper use and maintenance service as specified by APW and upon proper installation and start-up in accordance with the instructions supplied with each APW unit. APW's obligation under this warranty is limited to a period of one [1] year from the date of original installation, or eighteen [18] months from original invoice date, whichever occurs first. Defects that occur as a result of normal use, within the time period and limitations defined in this warranty, will at APW's discretion have the parts replaced or repaired by APW or a APW's-authorized service agency.

THIS WARRANTY IS SUBJECT TO ALL LISTED CONDITIONS

Repairs performed under this warranty are to be performed by an APW authorized service agency. APW will not be responsible for charges incurred or service performed by non-authorized repair agencies. In all cases, the nearest APW-authorized service agency must be used. APW will be responsible for normal labor charges incurred in the repair or replacement of a warranted product within 50 miles (80.5 km) of an authorized service agency. Time and expense charges for anything beyond that distance will be the responsibility of the owner. All labor will need to be performed during regular service hours. Any overtime premium will be charged to the owner. For all shipments outside the U.S.A. and Canada, please see the International Warranty for specific details. It is the responsibility of the owner to inspect and report any shipping damage claims, hidden or otherwise, promptly following delivery. No mileage or travel charges will be honored on any equipment that is deemed portable. In general, equipment with a cord and plug weighing less than 50 lb. (22.7 kg) is considered portable and should be taken or shipped to the closest authorized service agency, transportation prepaid.

CONTACT

Should you require any assistance regarding the operation or maintenance of any APW Manufacturing; phone or email our service department. In all correspondence provide the model number and serial number of the unit needing service; include the voltage or gas type.

Normal Business Hours: 8:00 a.m. to 4:30 p.m. Central

Telephone: 800-264-7827 Tech Service Option 2

Email: TechService@partstown.com

www.apwwyott.com

WARRANTY EXCLUSIONS

THE FOLLOWING WILL NOT BE COVERED UNDER WARRANTY.

APW's sole obligation under this warranty is limited to either repair or replacement parts, subject to the additional limitations detailed below. This warranty neither assumes nor authorizes any person to assume obligations other than those expressly covered by this warranty.

- Any product which has not been used, maintained, or installed in accordance with the directions published in the appropriate installation sheet and/or owner's manual, including incorrect gas or electrical connection. APW is not liable for any unit which has been mishandled, abused, misapplied, subjected to harsh chemicals, modified by unauthorized personnel, damaged by flood, fire, or other acts of nature [or God], or which have an altered or missing serial number.
- Installation, labor, and job checkouts, calibration of heat controls, air and gas burner/bypass/pilot adjustments, gas or electrical system checks, voltage and phase conversions, cleaning of equipment, or seasoning of griddle surface.
- Replacement of fuses or resetting of circuit breakers, safety controls, or reset buttons.
- Replacement of broken or damaged glass components, quartz heating elements, and light bulbs.
- Labor charges for all removable and consumable parts in gas charbroilers and hotplates, including but not limited to burners, grates, and radiants.
- Any labor charges incurred by delays, waiting time, or operating restrictions that hinder a service technician's ability to perform service.
- Replacement of parts that fail or are damaged due to normal wear or labor for replacement of parts that can be replaced during a daily cleaning routine, such as but not limited to silicone belts, PTFE non-stick sheets, control labels, knobs, bulbs, fuses, quartz heating elements, baskets, racks, and grease drawers.
- Any economic loss of business or profits.
- Non-OEM parts. Use of non-OEM parts without APW's approval will void the warranty.
- Units exceeding one [1] year from original installation date, or more than eighteen [18] months from original invoice date, whichever comes first.

ADDITIONAL WARRANTIES

- Specific/chain-specific equipment may have additional and/or extended warranties.

The foregoing warranty is in lieu of any and all other warranties expressed or implied and constitutes the entire warranty.