



# Installation, Operation and Service Manual

## **Bluezone® Model 450 Air Purification System**

**IMPORTANT SAFEGUARDS**  
**READ AND SAVE THESE INSTRUCTIONS**

**Safety**

This manual contains important instructions and safety information about the Bluezone Air Purification System. Observe the following dangers, warnings, cautions and notices when installing, operating and servicing the Bluezone Model 450.



Electrical System

Energized electrical circuits present a potentially life-threatening hazard.

Ensure the unit's power cord is unplugged before performing any installation or service work.

Ensure there are no other electrical power circuits connected to the Bluezone Model 450.

Do Not Operate unit with a damaged cord or plug. Discard unit or return to an authorized service facility for repair.

Follow all lockout/tagout procedures for all electrical circuits.



System Operation



**Do not operate the Bluezone Model 450 while fogging** with chlorine bleach or other disinfectant solutions. Disinfectants can poison the Bluezone catalyst and reduce its effectiveness.

- Turn off the Bluezone Units if disinfectant fogging or cleaning is underway.
- Turn Bluezone units back on after disinfectants have dissipated.

Never hose down the Bluezone Model 450 or clean with a water jet. Direct flow of water onto the catalyst can reduce its effectiveness in eliminating ozone.

Turn off Bluezone units and cover with plastic if the room is being hosed with water or steam.



System Maintenance

The Bluezone Model 450 contains 4 UV-C light bulbs; the UV light is completely contained inside the unit during operation.

Unplug or disconnect the unit from power source prior to any servicing.

The Bluezone Model 450 has multiple safety systems to ensure that you cannot view the UV bulbs while they are operating.

Do NOT attempt to override the cover switch to allow the bulbs to operate when the cover is off.

Skin or eye damage may result from directly viewing the light produced by the lamp in this apparatus. Always disconnect power before relamping or servicing. Replace lamps using Lamp Replacement Kit Model No. 005-000004, manufactured by Bluezone Products Inc. and sold by Authorized Bluezone Partner.

Never look at an illuminated UV-C bulb without proper eye protection against UV light frequencies.

### Description

The Bluezone® Model 450 is an air purification device that eliminates airborne contaminants including microbes (virus, fungi, mold and bacteria) and odors.

The Bluezone Model 450 draws in air containing viruses, mold, spores or fungus, and discharges air with a highly reduced concentration of these infectious impurities.

The unit is completely self-contained. The facility, equipment, and personnel have no contact with the process that is cleaning the air.

The Bluezone unit's operation is controlled by a microprocessor-based controller that ensures safe operation at all times and alerts the user to any system faults.

### Specifications

The specifications of the Bluezone Model 450 are shown in Table 1.

**Table 1: Bluezone Model 450 Specifications**

<b>Specification Category</b>	<b>Model 450</b>
<b>Size</b>	31" X 15" X 13 ½" 79cm X 38 cm X 34 cm
<b>Product Weight</b>	26 lbs./12 kg
<b>Shipping Size</b>	36" X 20" X 20" 91cm X 51cm X 51cm
<b>Shipping Weight</b>	29 lbs/13 kg
<b>Storage Environment</b>	-4°F – 150°F -20C – 65C
<b>Input Voltage</b>	120 VAC 1 Phase Or 240 VAC 1 Phase
<b>Current</b>	3 amps at 120 VAC 1.5 amps at 240 VAC
<b>Power</b>	310 Watts max at 120 VAC 350 Watts max at 240 VAC
<b>Electrical Connection</b>	IEC 320-C13 power cord
<b>Mounting Options</b>	Placed on shelf
<b>Certifications</b>	cETLus Listed ARB certified – Zero Ozone CE Mark

## Key Components

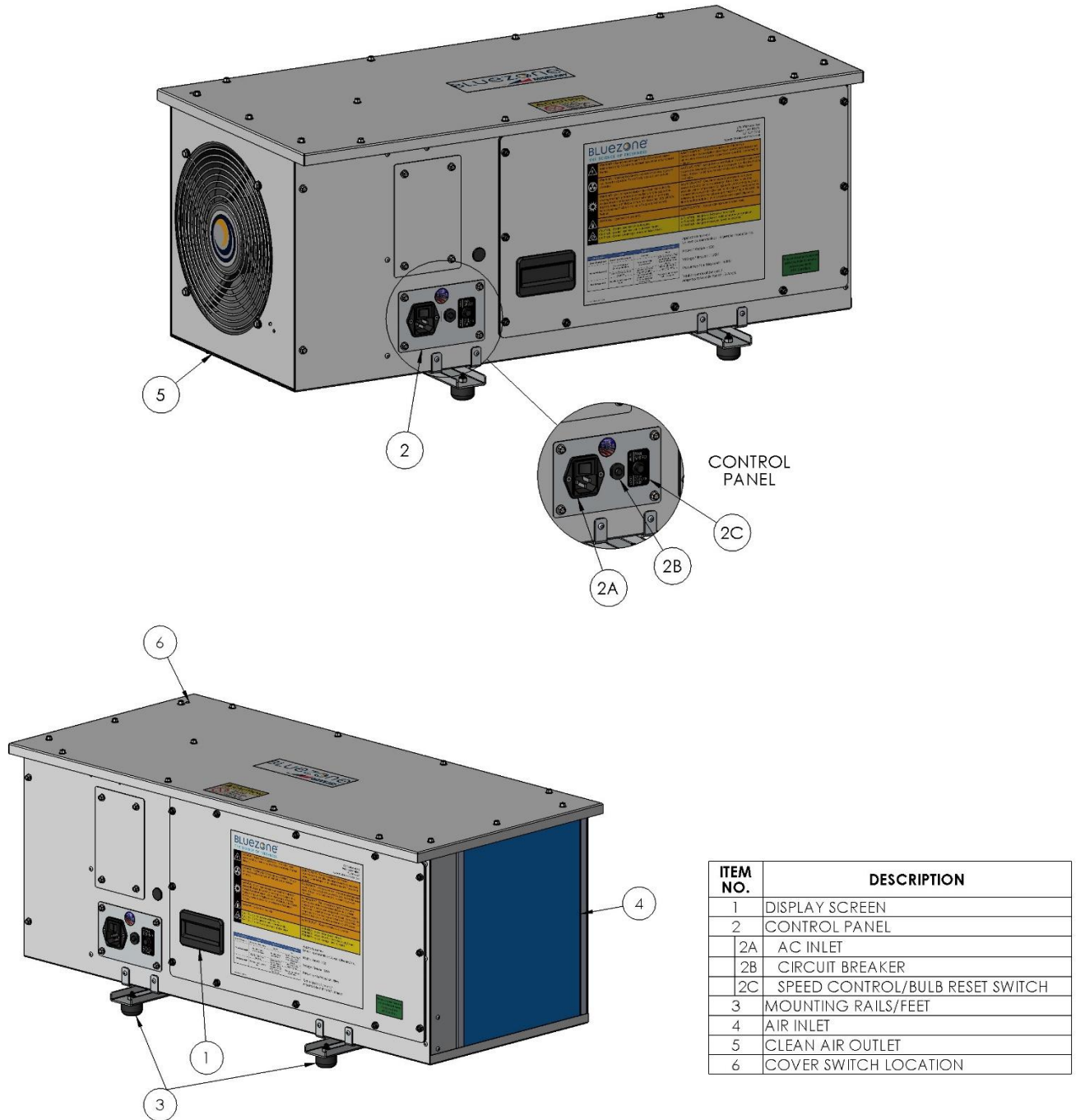

Figure 1: Bluezone Model 450 Key Components

## Electrical System

A wiring diagram of the Model 450 is shown in Figure 2. The wiring diagram applies to both the 120V and 240V SKUs of the Model 450. The asset tag on the Model 450 identifies the required voltage.

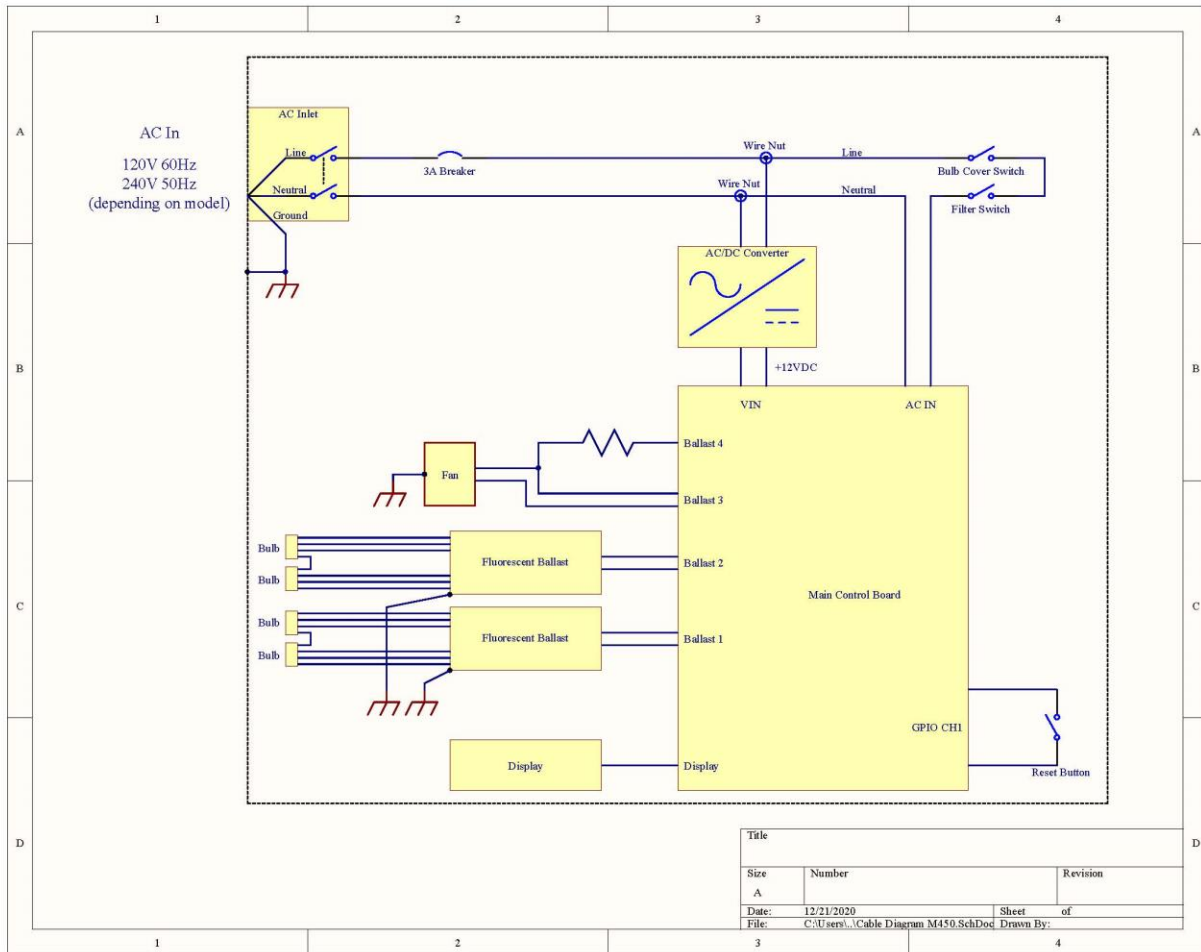

Figure 2: Wiring Diagram of the Model 450-052 (120V) and Model 450-055 (240V)

## Installation Guidelines



Place the Model 450 in the room so that air flow from the HVAC system, fans or other air flow systems does not blow directly into or pull air through the Model 450 air inlet or clean air outlet.

Ensure a minimum clearance distance of 2' (0.6m) from an HVAC ceiling diffuser, register or inlet grille to the Model 450.

Ensure a minimum clearance distance of 10' (3m) from the air outlet of an air conditioning or mini-split outlet to avoid forcing excessive air flow through the Bluezone unit.

Place the unit so that the control panel and display are visible and accessible.

If multiple Bluezone Model 450 units are being installed in a room, the following are recommended guidelines for the placement of the Bluezone units:

1. Distribute the units relatively evenly throughout the space.
2. Generally spreading the locations across the available space is good practice.
3.  Warning: If the unit is located in an area with foot traffic and there is a concern that it could be bumped by personnel, it should be labeled with colored tape to make it more visible and reduce the risk of collision.
4.  Warning: To avoid risk of injury from bumping into the unit, use the ceiling mount kit, Bluezone by Middleby cabinetry, or mount on shelf above head level.
5.  Warning: Locate the junction boxes for the units as close as possible to the units to avoid the risk of hooking the cord and pulling it out. If the distance to the junction box is more than 2' (0.6 m), the cord should be tied to the wall, rack, or ceiling to keep it protected.

## Mechanical Installation

The Bluezone unit can be installed by placing it on a shelf.

See Figure 4 for an image of shelf placement.

A drawing showing overall dimensions and mounting dimensions of the Model 450 is provided in Figure 3.

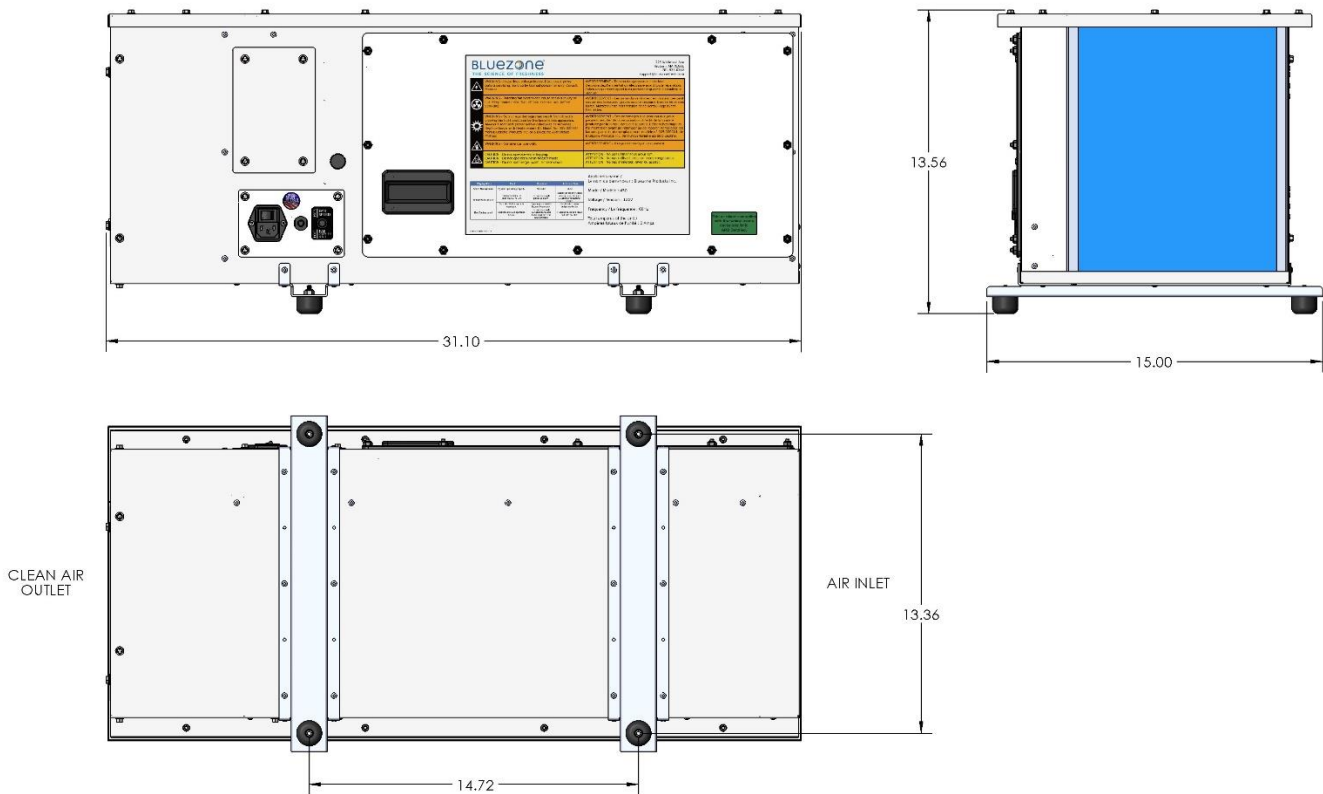

**Figure 3: Bluezone Model 450 Overall and Mounting Dimensions (units in inches)**

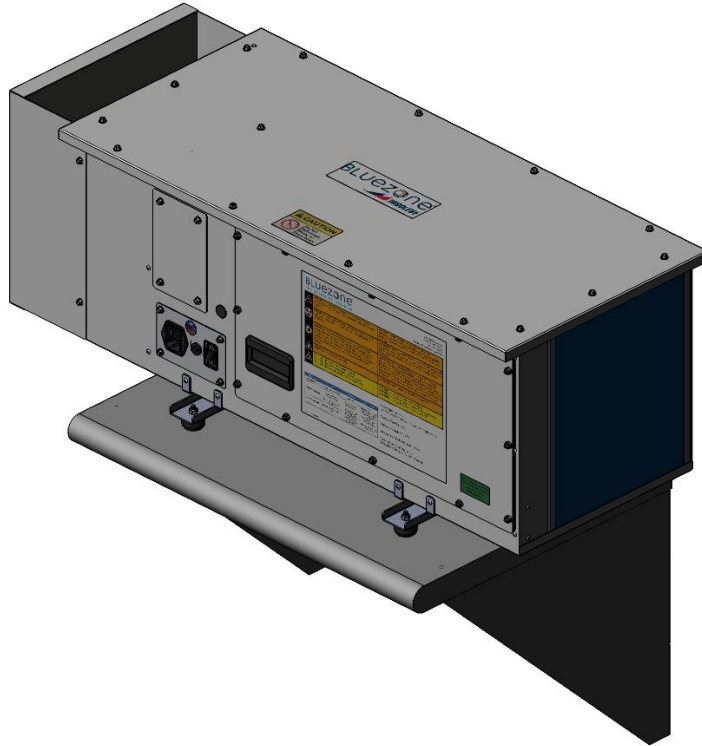

**Figure 4: Illustration of the Shelf Mount**



## Electrical Installation

The Bluezone unit is equipped with a power entry module.

Model 450-052 must be connected to 120V, 60Hz.

Model 450-055 must be connected to 240V, 50Hz.

The unit is cETLus listed at 120V.

The unit is CE marked at 240V.

The Model 450 is shipped with a 6' (2m) power cord for either 120V or 240V depending on the model.

Plug the power cord into the power entry module.

Once the Model 450 is positioned mechanically in the space, plug the cord into the nearest un-switched electrical outlet rated to the voltage on the unit's model/serial number plate.

Secure the cord.



**Warning** The power cord is attached to the front of the unit and may be caught and pulled during activities in the space. Secure the power cord to the shelving, wall or other stable surface.

## Electrical Requirements

Model 450-052

Input Voltage: 120VAC

Input Frequency: 60Hz

Input Current: 3A max @ 120VAC

Input Power: 310W max

Model 450-055

Input Voltage: 240VAC

Input Frequency: 50Hz

Input Current: 1.5A max @ 240VAC

Input Power: 350W max

## Operation

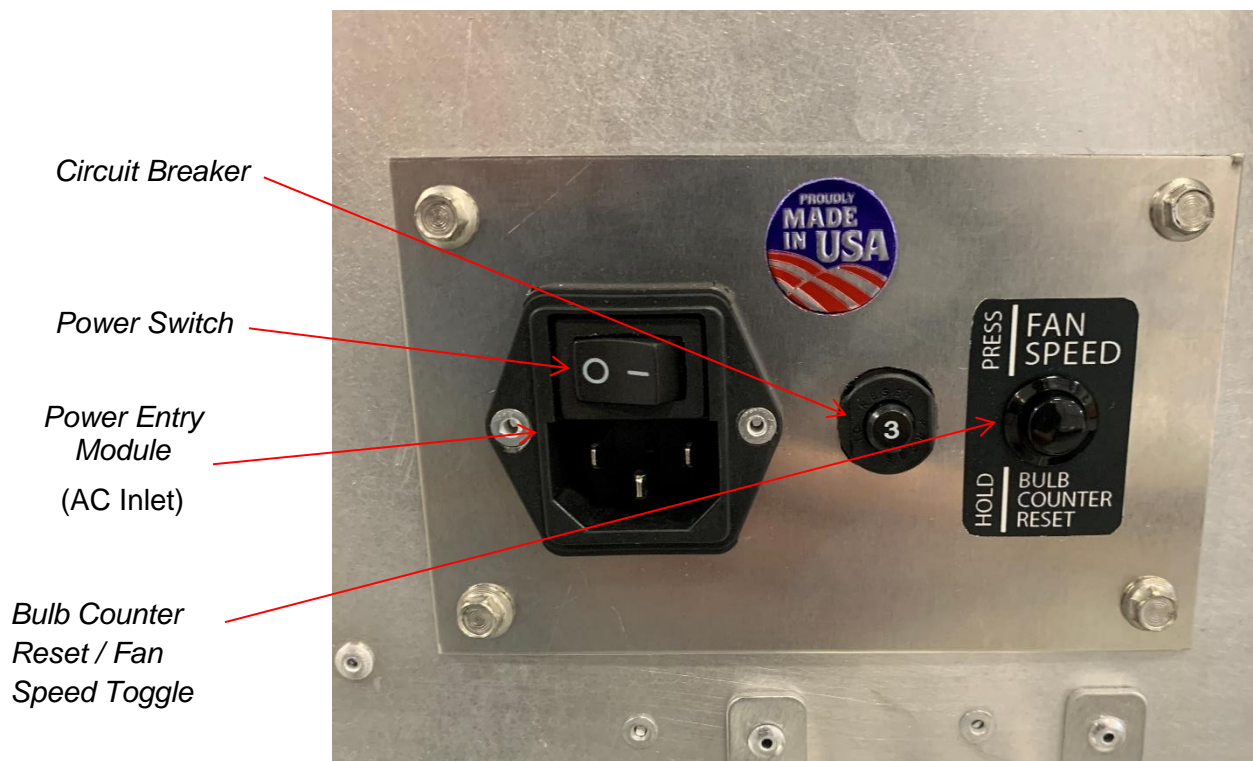

**Figure 5: Control Panel on Bluezone Unit**

Once the Model 450 is mounted and wired, it can be turned 'On' using the power switch on the control panel.

Toggle the power switch to the "On" position to energize the unit.

### Normal Operation

Once the Bluezone is switched "On", the Display Screen will indicate "Bluezone" on a green background on the top line.

The bottom line of the display screen will confirm bulb operation, a bulb life remaining counter and fan setting.

### High/Low Speed:

The Bluezone Model 450 has two fan speeds: high and low. Press the bulb counter reset / fan speed toggle once to change fan speed.

For more information on the bulb reset counter please refer to the Service Section on Page 15.

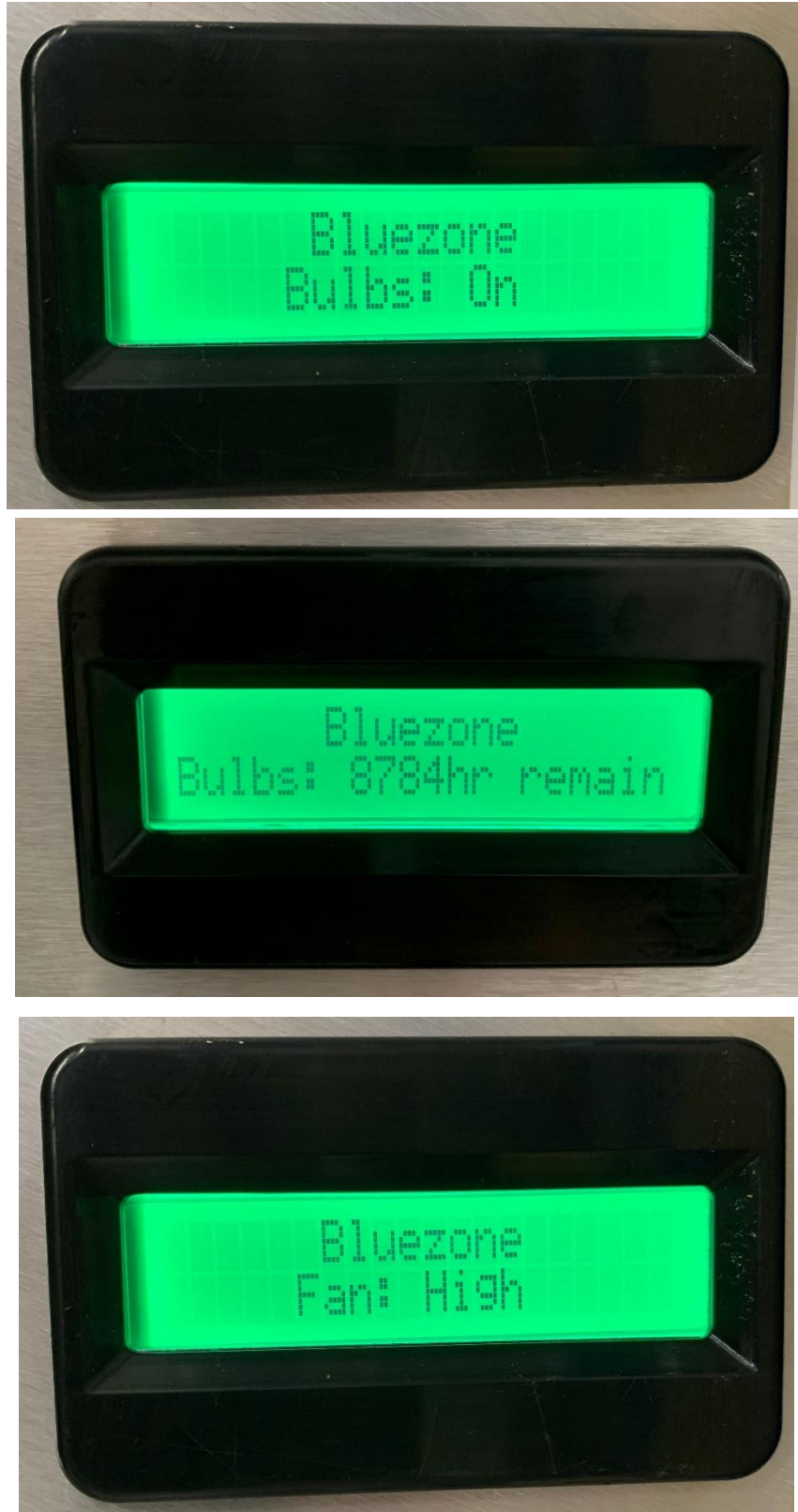

Figure 6: Display Sequence in Time

## Fault Conditions and Fault Codes

If there are issues with the operation of the Model 450, the onboard diagnostics will indicate the nature of the problem.

Display Screen codes are shown in **Table 2**.

**Table 2: Display Screen Status Indicator Fault Codes**

Display Color	Display Text	Fault	Operation	Action to Take
<b>Green Background</b>	Bluezone Unit conditions scrolling	System operating properly.	Operates	None
<b>Yellow Background</b>	Contact Bluezone	Fan not rotating, or Bulb counter failure	Unit automatically powered down.	Check fan for any visible obstructions. Contact Bluezone Products for service.
	Replace Bulbs, Unit conditions scrolling	Bulb life >7,200 hours of operation.	Operates until 8,800 hours of operation.	Check bulb counter Order new bulbs
<b>Red Background</b>	Replace Bulbs	Bulb life at 8,800 operation hours.	Unit automatically powered down until bulbs replaced and counter reset.	Replace bulbs and reset bulb life counter.

## Troubleshooting

If the Display Screen has no light or text then the Model 450 is not being powered. Check the following list for possible causes and solutions:

1. Make sure the cover is on and the Cover Switch tab engages inside the cover switch opening.

Note: Controls will not energize if the cover is off or if the cover switch is not engaged.

See Figure 7 for proper installation of the cover switch.

2. Check that unit is powered.
  - a. Power “Off” unit by pressing the power switch located on the control panel.
  - b. Plug unit in.
  - c. Turn unit “On.”

3. Restart the unit.
  - a. Power “Off” unit by pressing the power switch located on the control panel.
  - b. Wait 5 seconds.
  - c. Turn unit “On.”
4. Check whether the unit’s circuit breaker has tripped.
  - a. Visually check the circuit breaker located on the control panel. If a white strip is visible, then the breaker needs to be reset.
  - b. Power “Off” unit using the power switch located on the control panel.
  - c. Reset circuit breaker located on the control panel by pushing the visible indicator back into the circuit breaker.
  - d. Turn unit “On” using the power switch located on the control panel.



**Danger**

**DO NOT** override the cover switch when the cover is removed. UV light will be emitted.

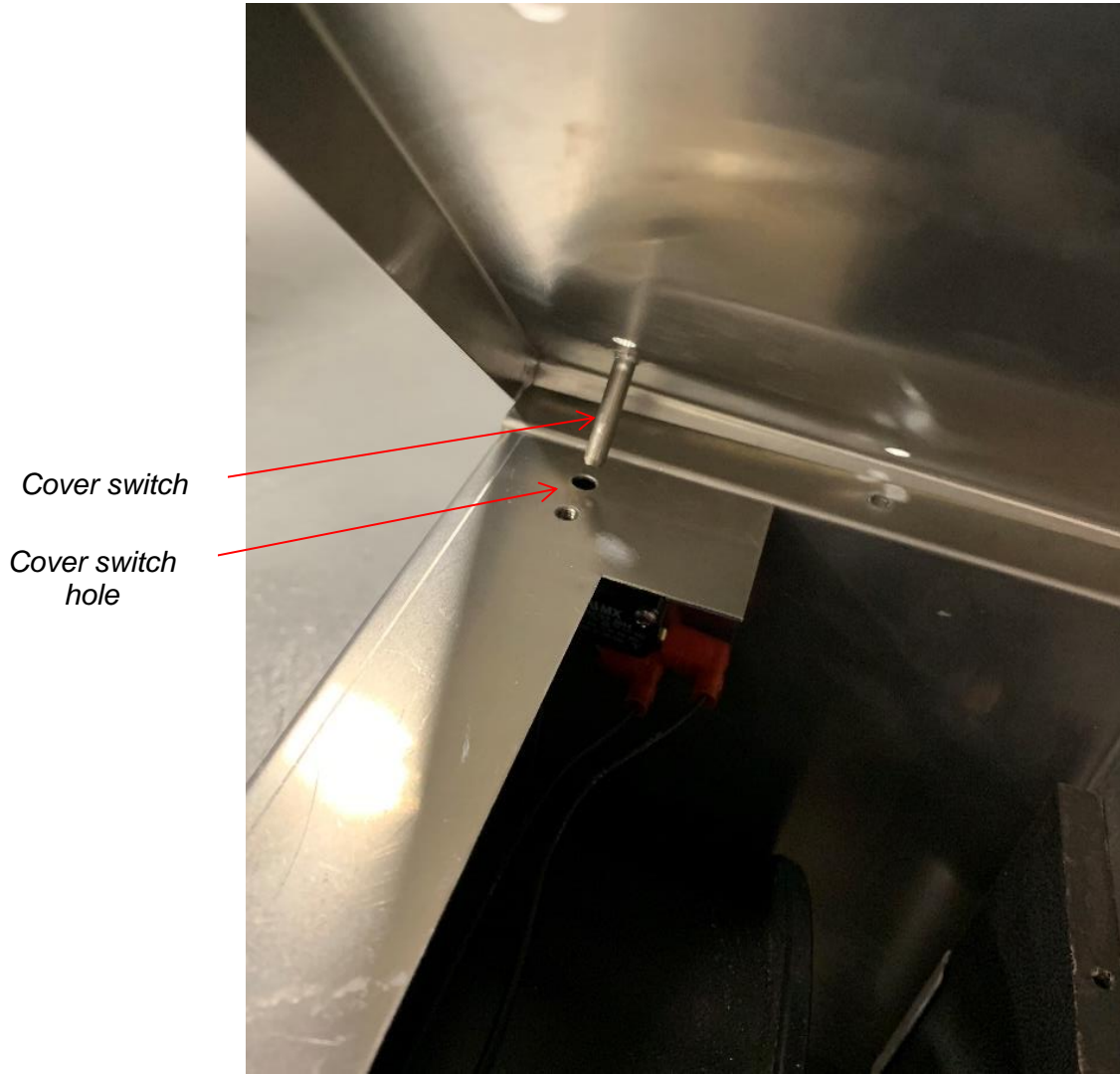

**Figure 7: Bluezone Model 450 Cover Switch and Cover Switch Hole**

## **New Equipment Warranty**

Online warranty registration form must be completed to validate your New Equipment Warranty. Please visit [www.BluezoneFresh.com](http://www.BluezoneFresh.com) to complete the online warranty registration.

Bluezone Products, Inc. warrants that new equipment manufactured in Bluezone's facilities are free of defects due to poor materials or workmanship for a period of 1 year from the date of purchase.

Bluezone Products, Inc. warrants that the equipment will function properly, to our specifications and will be repaired, if necessary, at no charge for a period of 1 year (See our warranty policy for details).

All Bluezone products have been tested by independent labs and in many facilities, proving the performance as described in our literature. Our air purification equipment is a powerful tool to help purify your environment yet, we cannot guaranty that under your operating conditions and procedures, the results will be the same as experienced by other users.

If you are not satisfied with the purchase or the operation of our equipment, it can be returned if the equipment was un-used and was returned within 14 days. The customer will be charged return freight and an additional 15% restocking fee.

## **Bulb Disposal**

Bulbs contain a small amount of mercury

Bulb handling should be similar to that used for fluorescent or compact fluorescent bulbs.

Bluezone Products, Inc. recommends that you take advantage of available local recycling options for CFLs. Lists of recycling facilities are available at: [www.earth911.org](http://www.earth911.org).

Dispose of according to local, state or federal laws.

## Service

### **BULBS NEED TO BE REPLACED AFTER 8,800 HOURS OF USE. BULB KITS MUST BE PURCHASED DIRECTLY FROM BLUEZONE PRODUCTS OR AN AUTHORIZED PARTNER AS THEY ARE PROPRIETARY BULBS.**

Bulbs must be replaced at 8,800 hours of operation. The display screen reads bulb hours of operation remaining. At 1,600 hours remaining the display screen will turn yellow and read "Replace Bulbs." The bulbs should be ordered and replaced immediately. At 0 hours remaining, the display screen will turn red and the unit will automatically be powered **OFF** until bulbs are replaced.

After bulbs are replaced, the bulb counter needs to be reset. To reset the bulb counter please follow the steps below.

- 1) Press and hold the bulb counter reset button for 3 seconds. The display screen will read "Hold: reset counter" during the 3 second hold.
- 2) After holding for 3 seconds, the display screen will read "push to confirm." Release button and push to confirm reset.

A bulb replacement kit and instructions can be ordered from Evo America. The Lamp

Replacement Kit for the Bluezone Model 450 is: 005-000004.

Please call 503-626-1802 or email [sales@evoamerica.com](mailto:sales@evoamerica.com) for ordering information.

**IMPORTANT:** Each bulb kit satisfies replacement parts for 1 unit. The four bulbs in each replacement kit cannot be replaced with bulbs purchased from anywhere, but Bluezone Products or an Authorized Partner. Installation of the incorrect bulbs results in a voided warranty. Purchase of bulbs from an outside vendor results in a voided warranty. Bluezone will not operate correctly with bulbs purchased from outside vendors.

#### **Service Kit includes:**

- (4) U-shaped bulbs
- (2) Nitrile gloves
- Extra cover screws

#### **Additional tools needed:**

- ¼" hex nut driver



**Instructions for Bulb Replacement:**

- 1) Toggle the power switch located on the unit's control panel to OFF.
- 2)  **WARNING:** Before proceeding to next step, unplug the unit from it's power supply.
- 3) Use the ¼" hex nut driver to unscrew the 14 screws on the cover, see Figure 8 below.
- 4) Slowly, remove the cover and place it on a flat surface.
- 5) Use the gloves provided to remove and replace the bulbs. This will prevent oil on your hand from damaging the new bulbs.
- 6) Note the orientation of the Bulb Support Wires. Unscrew the ¼" screws on Bulb Support Wires. See Figure 9 below.
- 7) Carefully remove Bulb Support Wires and place aside to replace after bulb changeout. See Figure 10 below.
- 8) Unscrew ¼" screws on Bulb Clips. See Figure 11 below.
- 9) Remove the old bulbs (Note: pull on them at the ceramic base, not on the glass) Put the bulbs to the side for disposal.
- 10) Carefully remove Bulb Clips and place aside. See Figure 12 below.
- 11) Hold replacement bulbs by the ceramic end and push the pins into the slots in the receptacle.
  - ⇒ They need to be pushed in until a "click" is heard and felt.
- 12) Put Bulb Clips over new bulbs and use screws to tighten Bulb Clips in place.
- 13) Replace Bulb Support Wires on top and bottom of bulb pairs. Use screws to tighten Bulb Support Wires in place.
- 14) Tighten cover back onto the unit.
- 15) Dispose of used bulbs, according to standard practice for florescent bulbs.

**IMPORTANT**

- 16) Press and hold the bulb counter reset button for 3 seconds. The display screen will read "Hold: reset counter" during the 3 second hold.
- 17) After holding for 3 seconds, release and press the bulb counter reset button again to finalize reset. The display screen will read "push to confirm" after the 5 second hold.

Estimated total bulb replacement time:  
approximately 20 minutes per unit.



**Figure 8: Remove Bluezone Cover by Removing 1/4" screws**

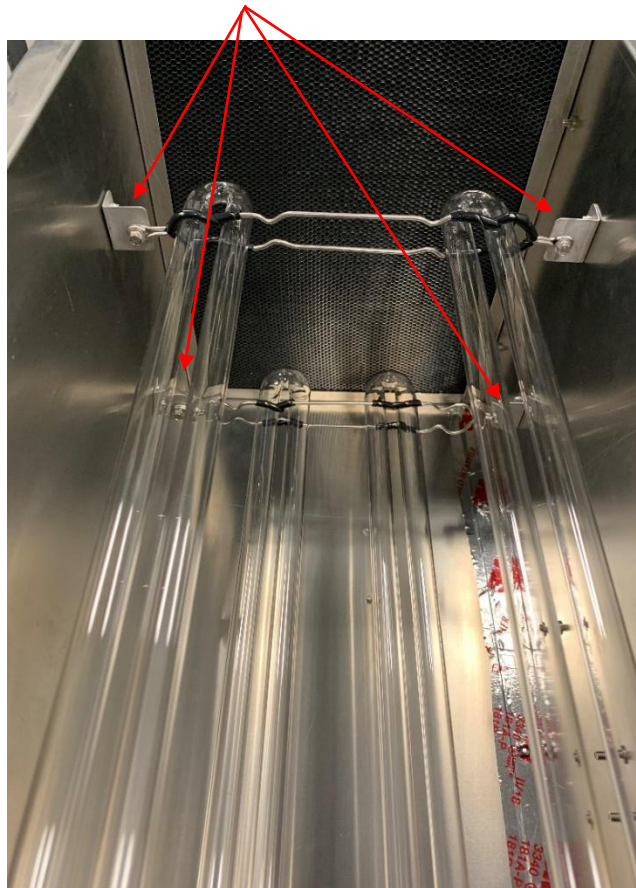

**Figure 9: Remove 1/4" Screws Holding Bulb Support Wires**

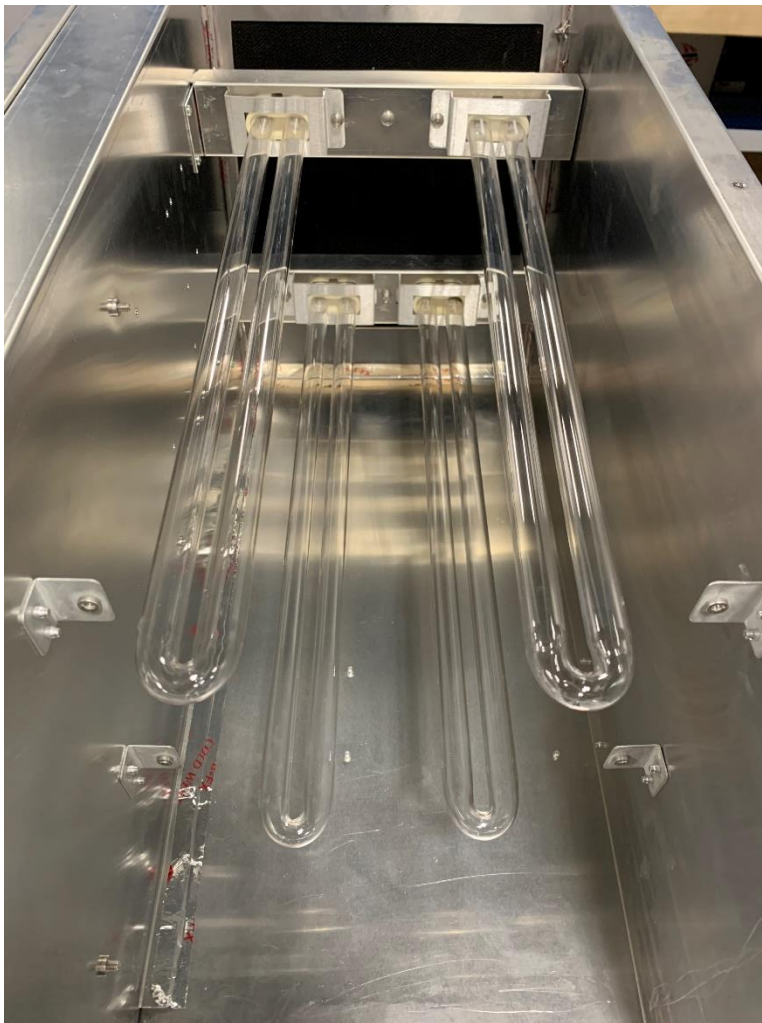

**Figure 10: Remove Bulb Support Wires and Place aside**

1/4 screws



**Figure 11: Remove 1/4" Screws on Bulb Support Clips**



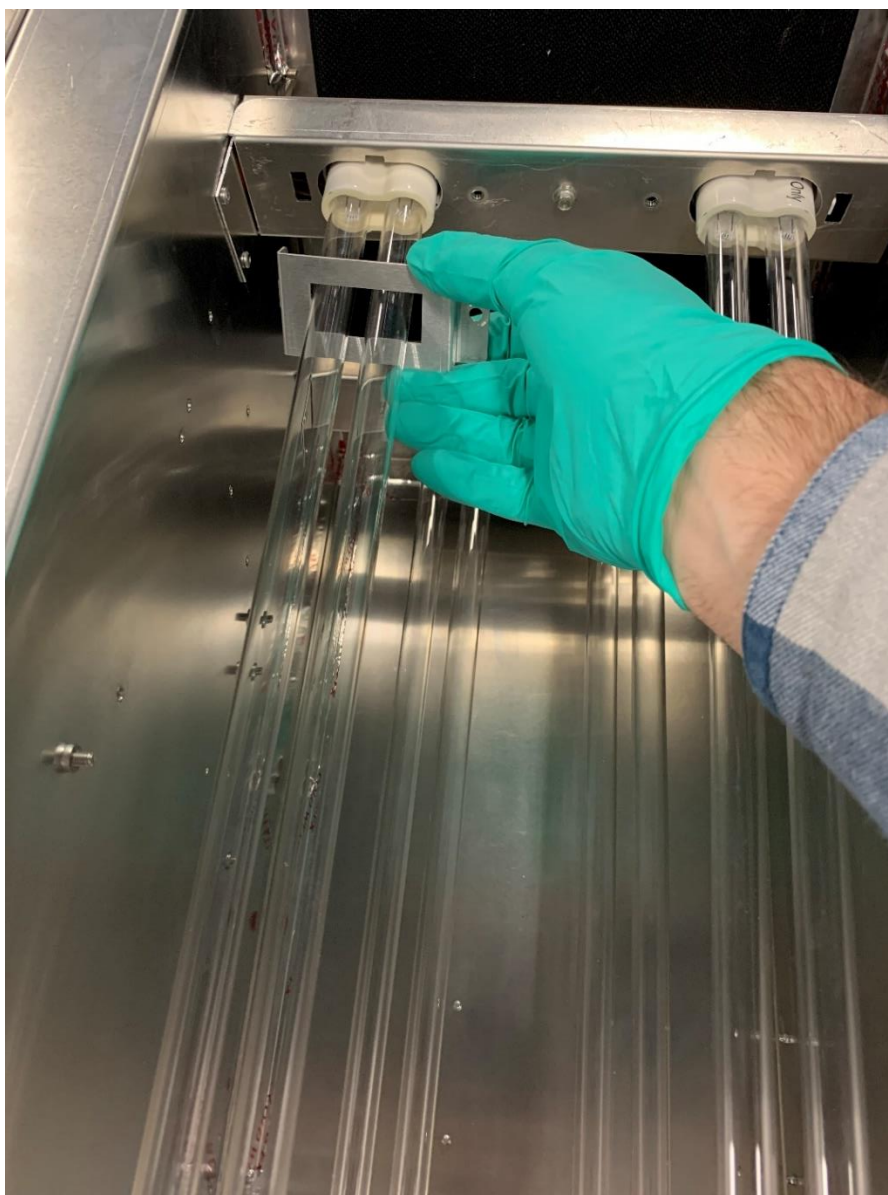

**Figure 12: Carefully Slide off Bulb Clips using Nitrile Gloves**



**Figure 13: Remove all Four Old Bulbs by Carefully Pulling on the Ceramic Base**



**Figure 14: Install 4 New Bulbs. Do not Touch Bulbs with Bare Hands**

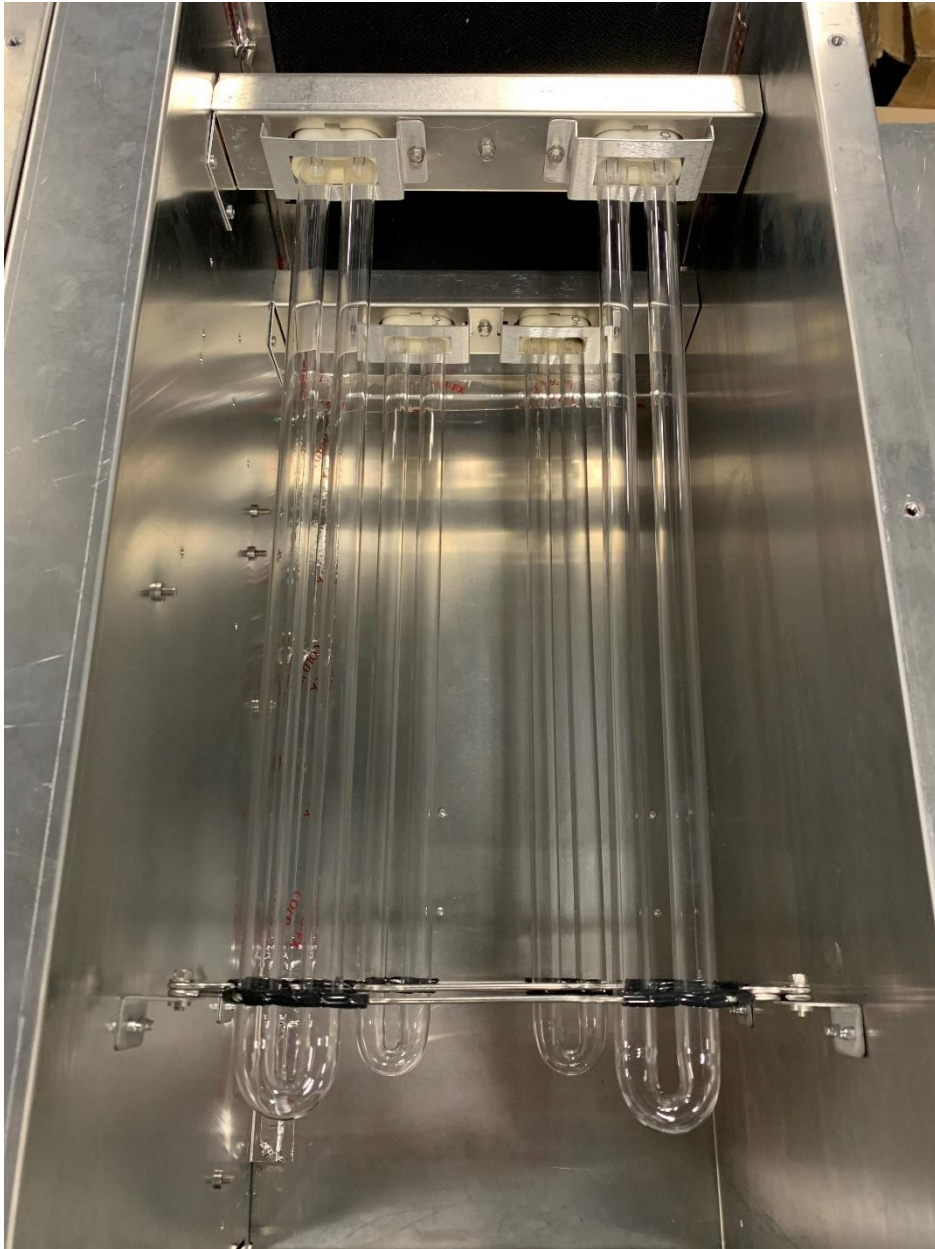

**Figure 15: Install Bulb Clips**





**Figure 16: Install Bulb Support Wires**



**Figure 17: Completed Assembly**

## Model 450 Muffler Installation Instructions

Materials needed:

- Bluezone Model 450 Muffler
- ¼" hex nut driver

1. Remove (4) ¼" drive screws from the fan end of the Bluezone Model 450 as shown in Figure 18

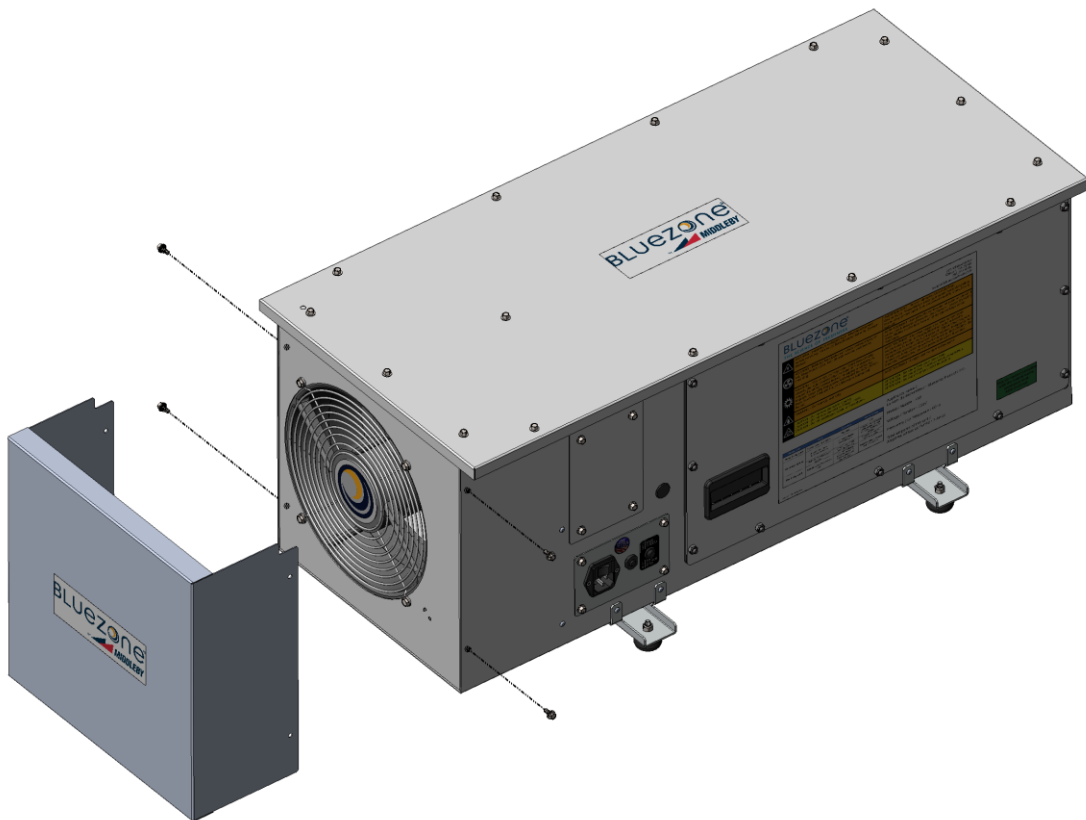

Figure 18: Screw Removal for Muffler Installation

2. Place Muffler over end of Bluezone Model 450
3. Reinstall (4) 1/4" drive screws to secure the muffler in place.

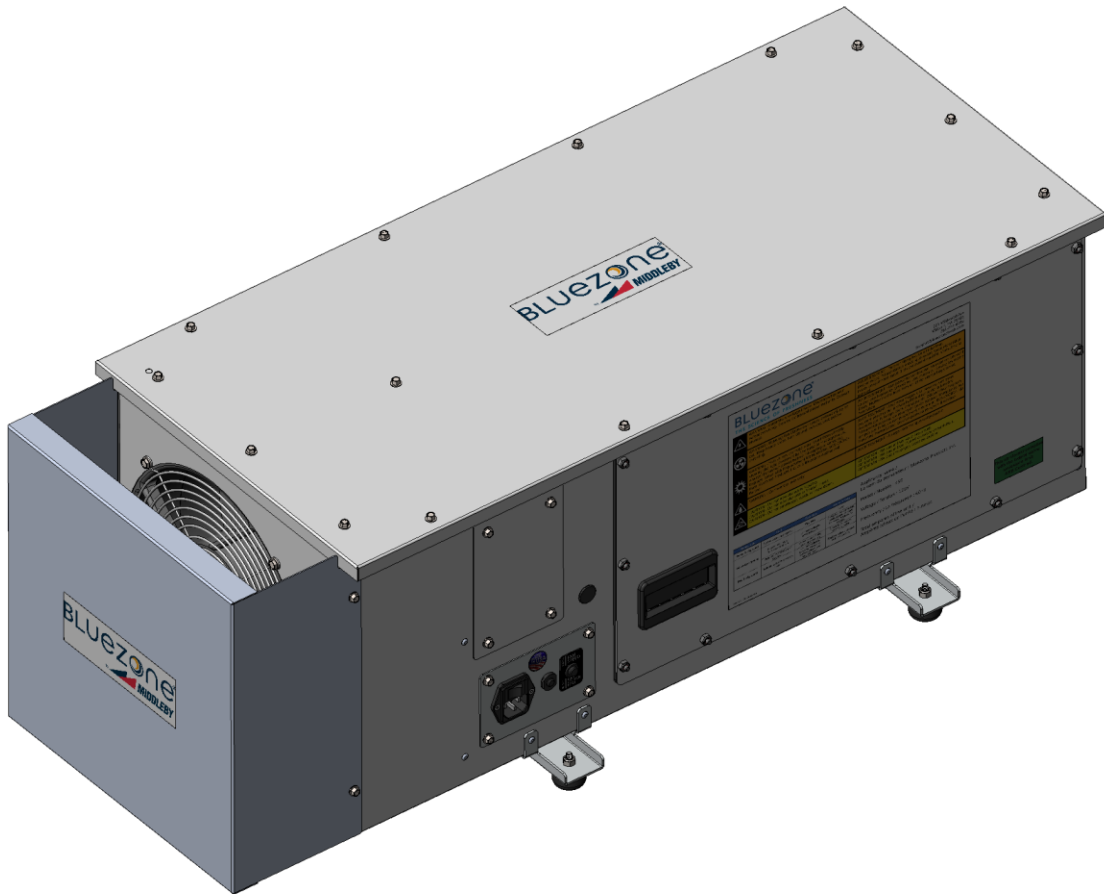

Figure 19: Installed Muffler

**Technical Support is provided by:**

Evo America, LLC  
A Middleby Company  
Our Ventless and Air Purification Experts

20360 SW Avery Court  
Tualatin, OR 97062  
USA

503-626-1802  
866-626-1802 Toll-Free  
support@evoamerica.com

**BLUEzone**<sup>®</sup>

BY  **MIDDLEBY**