

# USER GUIDE & SERVICE MANUAL



Model: UCBF632-SS12A

# USER GUIDE & SERVICE MANUAL

---

**[Click on any section below to jump directly there](#)**

## Table of Contents

Intro

## Safety

Safety and Warning

Disposal And Recycling

## Installation

Environmental Requirements

Electrical

Cutout & Product Dimensions

General Installation

Interior Adjustments

## Maintenance

Cleaning

Cleaning Condenser

Extended Non-Use

## Operating Instructions

Control Operation

## Service

Troubleshooting

Wire Diagram

Product Liability

Parts

Ordering Replacement Parts

R600a Specifications

System Diagnosis Guide

Compressor Specifications

Warranty

---

# USER GUIDE

---

## WELCOME TO U-LINE

Congratulations on your U-Line commercial purchase. Your product comes from a company with over five decades of premium modular ice making, refrigeration, and wine preservation experience. U-Line continues to be the American leader in refrigeration, delivering versatility and flexibility for multiple applications, including: residential, commercial, outdoor and marine use. U-Line's commercial collection includes reach-in refrigerators and freezers, dispensers, ice machines, undercounter refrigeration and wine, back bar refrigeration, blast chillers and shock freezers, base refrigerators and freezers, and pizza and food prep tables.

U-Line has captivated those who have an appreciation for the finer things combined with exceptional functionality, style, inspired innovations, and attention to even the smallest details. We are known and respected for our unwavering dedication to product design, quality, and selection. Headquartered in Milwaukee, Wisconsin, U-Line has shipped product to five continents for over two decades and is proud to have the opportunity to ship to you.

## U-LINE — RIGHT PRODUCT. RIGHT PLACE. RIGHT TEMPERATURE.®

### PRODUCT INFORMATION

Looking for additional information on your product? User Guides, Spec Sheets, CAD Drawings, and Product Warranty information are available digitally on [u-line.com](http://u-line.com)

### PROPERTY DAMAGE / INJURY CONCERNS

In the unlikely event property damage or personal injury is suspected related to a U-Line product, please take the following steps:

1. U-Line Customer Care must be contacted immediately at +1.414.354.0300.
2. Service or repairs performed on the unit without prior written approval from U-Line is not permitted. If the unit has been altered or repaired in the field without prior written approval from U-Line, claims will not be eligible.

### GENERAL INQUIRIES

U-Line Corporation  
8900 N. 55th Street  
Milwaukee, Wisconsin 53223 USA  
Monday – Friday 8:00 am to 4:30 pm CST  
T: +1.414.354.0300  
Email: [sales@u-line.com](mailto:sales@u-line.com)  
[u-line.com](http://u-line.com)

### SERVICE & PARTS ASSISTANCE

Monday – Friday 8:00 am to 4:30 pm CST  
T: +1.414.354.0300  
Service Email: [onlineservice@u-line.com](mailto:onlineservice@u-line.com)  
Parts Email: [onlineparts@u-line.com](mailto:onlineparts@u-line.com)



### CONNECT WITH US

## Safety and Warning

### NOTICE

**Please read all instructions before installing, operating, or servicing the appliance.**

Use this appliance for its intended purpose only and follow these general precautions with those listed throughout this guide:

### SAFETY ALERT DEFINITIONS

Throughout this guide are safety items labeled with a Danger, Warning, or Caution based on the risk type:

### DANGER

**Danger means that failure to follow this safety statement will result in severe personal injury or death.**

### WARNING

**Warning means that failure to follow this safety statement could result in serious personal injury or death.**

### CAUTION

**Caution means that failure to follow this safety statement may result in minor or moderate personal injury, property, or equipment damage.**



**Caution: risk of fire, flammable refrigerant, and blowing gas used.**

### GENERAL PRECAUTIONS

Use this appliance for its intended purpose only and follow these general precautions along with those listed throughout this guide.

This appliance is not intended for use by persons (including children) with reduced physical, sensory or mental capabilities, or lack of experience or knowledge, unless they have been given supervision or instruction concerning use of the appliance by a person responsible for their safety.

Children should be supervised to ensure that they do not play with this appliance.

### WARNING

**Failure to follow all the instructions in this manual can cause property damage, injury, or death.**

### WARNING

**The user must read the information given in this Manual, very carefully, with particular attention to the appropriate precautions for Safety listed in this chapter. The user must follow this list:**

- **Keep the refrigerator clean and tidy**
- **Do not remove or alter plaques placed by the Manufacturer**
- **Do not remove or bypass safety systems**
- **Do not touch the equipment with damp or wet hands or feet**
- **Do not touch the equipment with bare feet**
- **Do not insert screwdrivers or anything else between the protective cover and the moving parts**
- **Do not pull the power cable to disconnect the appliance from the power supply**
- **Before cleaning or performing maintenance, disconnect the appliance from the electric power supply by switching off the main switch and removing the plug**

### WARNING

**Keep all ventilation openings clear of obstruction in the appliance enclosure.**

## WARNING

Do not store explosive substances, such as aerosol cans, with a flammable propellant in this appliance.

## WARNING

Comply with local regulations regarding disposal of the appliance for its flammable refrigerant and blowing gas. Before disposing of the appliance, remove the doors to prevent child entrapment.

## WARNING

Do not use mechanical devices or other means to accelerate the defrosting process, other than those recommended by the manufacturer.

## WARNING

The refrigerator must not be used:

- For purposes differing from its intended use
- In an explosive, aggressive atmosphere, or where there is a high concentration of oily substances or powders suspended in the air
- In an atmosphere with a fire risk
- When exposed to bad weather
- With adapters, multiple sockets, or extension leads

## WARNING

If repairs or maintenance have to be carried out requiring the removal of the safety devices, all power sources must be switched off. Deactivate the electric plant, turning off the main switch and pulling out the plug. After the work is finished, all safety devices must be re-activated.

## WARNING

Do not damage the refrigerating circuit.

## WARNING

Do not use electrical appliances inside the food/ice storage compartments unless they are of the type recommended by the manufacturer.

## NOTICE

Never install or operate the unit behind closed doors. Be sure front grille is free of obstruction. Obstructing free airflow can cause the unit to malfunction and will void the warranty.

## NOTICE

This appliance is intended to be used in commercial and similar applications such as: Communities, restaurants, hotels, retail providers, and similar applications.

### GENERAL SAFETY

## WARNING

Do not operate this equipment without properly placing and securing all covers and access panels. Failure to comply with this procedure can cause property damage, injury, or death.

## WARNING

Do not use or store gasoline or other flammable vapors or liquids in the vicinity of this or any other appliance. Failure to comply can cause property damage, injury, or death.

## WARNING

In the event of a power failure, do not attempt to operate this appliance. Failure to comply can cause property damage, injury, or death.

## WARNING

U-Line accepts no responsibility for any situation resulting from work carried out in an unprofessional manner, or from the incorrect interpretation or application of regulations.

## WARNING

Repair work must only be performed by U-Line's approved distributors or one of its authorized representatives. U-Line accepts no responsibility for any situation resulting from work performed by untrained and/or unauthorized technicians.

## Disposal and Recycling



**RISK OF CHILD ENTRAPMENT. Before you throw away your old refrigerator or freezer, take off the doors and leave shelves in place so children may not easily climb inside.**

If the unit is being removed from service for disposal, check and obey all federal, state, and local regulations regarding the disposal and recycling of refrigeration appliances, and follow these steps completely:

1. Remove all consumable contents from the unit.
2. Unplug the electrical cord from its socket.
3. Remove the door(s)/drawer(s).

## Environmental Requirements

This unit is designed to operate between 45°F (7°C) and 77°F (25°C). For example, this unit will be effective whether you operate it in a cold room or hot kitchen.

Higher ambient temperatures may reduce the unit's ability to reach low temperatures.

For best performance, keep the unit out of direct sunlight and away from heat generating equipment.

In climates where high humidity and dew points are present, condensation may appear on outside surfaces. This is considered normal. The condensation will evaporate when the humidity drops.



**Damages caused by ambient temperatures of 40°F (4°C) or below are not covered by the warranty.**

## Electrical

### ELECTRICAL WARNINGS

#### WARNING

Never remove the round grounding prong from the plug and never use a two-prong grounding adapter.

#### WARNING

Altering, cutting or removing power cord, removing power plug, or direct wiring can cause serious injury, fire, loss of property and/or life, and will void the warranty.

#### WARNING

Never use an extension cord to connect power to the unit.

#### WARNING

Always keep your working area dry.

#### WARNING

Electrical connections should be performed only by a certified professional. Electrical and grounding connections must comply with the applicable portions of the National Electric Code and/or all local electric codes. Failure to comply with this procedure can cause property damage, injury, or death.

#### WARNING

Make sure all facility electrical connections comply with all local and federal electrical code regulations.

#### WARNING

Electrical connections or any work required on the electrical circuits inside the appliance must be performed by certified technicians in compliance with local, state, and federal regulations.

#### WARNING

Before connecting the unit to the electrical supply, verify that the electrical and grounding connections comply with the applicable portions of the National Electric Code and/or other local electrical codes. Failure to comply with this procedure can cause property damage, injury, or death.

#### WARNING

Before connecting the unit to the electrical supply, verify that the electrical connection agrees with the specifications on the data plate. Failure to comply with this procedure can cause property damage, injury, or death.

#### WARNING

Appliance must be connected to a grounded, metal, permanent wiring system. Or an equipment-grounding conductor must be run with the circuit conductors and connected to the equipment-grounding terminal or lead on the appliance. Failure to comply with this procedure can cause property damage, injury, or death.

#### WARNING

Appliances equipped with a flexible electric supply cord, are provided with a three-prong grounding plug. This plug must be connected into a properly grounded three-prong receptacle. Failure to comply with this procedure can cause property damage, injury, or death.

#### WARNING

If the receptacle is not the proper grounding type, contact an electrician. Do not remove the grounding prong from the plug. Failure to comply with this procedure can cause property damage, injury, or death.

#### NOTICE

Electrical installation must observe all state and local codes. This unit requires connection to a grounded (three-prong), polarized receptacle that has been placed by a qualified electrician.



## ELECTRICAL LOCKOUT/TAGOUT PROCEDURE

### **WARNING**

**Before removing any sheet metal panels, always perform the Electrical LOCKOUT/TAGOUT Procedure. Be sure all circuits are disconnected. Failure to comply with this procedure can cause property damage, injury, or death.**

### **WARNING**

**Before performing any service that involves electrical connection or disconnection and/or exposure to electrical components, always follow the Electrical LOCKOUT/TAGOUT Procedure. Disconnect all circuits. Failure to comply can cause property damage, injury or death.**

**The Electrical LOCKOUT/TAGOUT Procedure is used to protect personnel working on an electrical appliance. Before performing any maintenance or service that requires exposure to electrical components, follow these steps:**

- 1. In electrical box, place appliance circuit breaker into OFF position.**
- 2. Place a lock or other device on electrical box cover to prevent someone from placing circuit breaker ON.**
- 3. Place a tag on electrical box cover to indicate that appliance has been disconnected for service and power should not be restored until tag is removed by maintenance personnel.**
- 4. Disconnect appliance power cord from electrical outlet.**
- 5. Place a tag on the cord to indicate that unit has been disconnected for service and power should not be restored until tag is removed by maintenance personnel.**

The unit requires a grounded and polarized 208 – 220 VAC, 60 Hz, 30A power supply (normal household current). An individual, properly grounded branch circuit or circuit breaker is recommended. A GFCI (ground fault circuit interrupter) is usually not required for fixed location appliances and is not recommended for your unit because it could be prone to nuisance tripping. However, be sure to consult your local codes.

See CUTOUT & PRODUCT DIMENSIONS for recommended receptacle location.

## Cutout & Product Dimensions

### PREPARE SITE

Your U-Line product has been designed for free-standing installation. The free-standing units require specific clearances to run most efficiently.

**NOTE: Measurements in inches (mm).**



**Unit can NOT be installed behind a closed door.**

### CUTOUTS

This unit does not require cutout dimensions.

### PRODUCT DIMENSIONS

Refer to Figure 1, Figure 2, and Figure 3, for the dimensions of the unit.

### CLEARANCES

Maintain the following clearances when installing this unit:

- Make sure the unit is not installed near the following sources of heat (and similar):
  - Ovens
  - Radiator
  - In the path of direct sunlight
- Allow for a space of at least 11-13/16" (300 mm) between the back of the unit and any wall. This distance helps to avoid condensation forming
- Make sure the motor is free of any obstacle which could hinder or limit the circulation of the condensing unit
- Allow for a space of at least 19-11/16" (500 mm) between the top of the unit and the ceiling (see Figure 4)
- Make sure the environment allows for adequate airflow to guarantee cooling for the condenser and the compressor unit (see Figure 5)

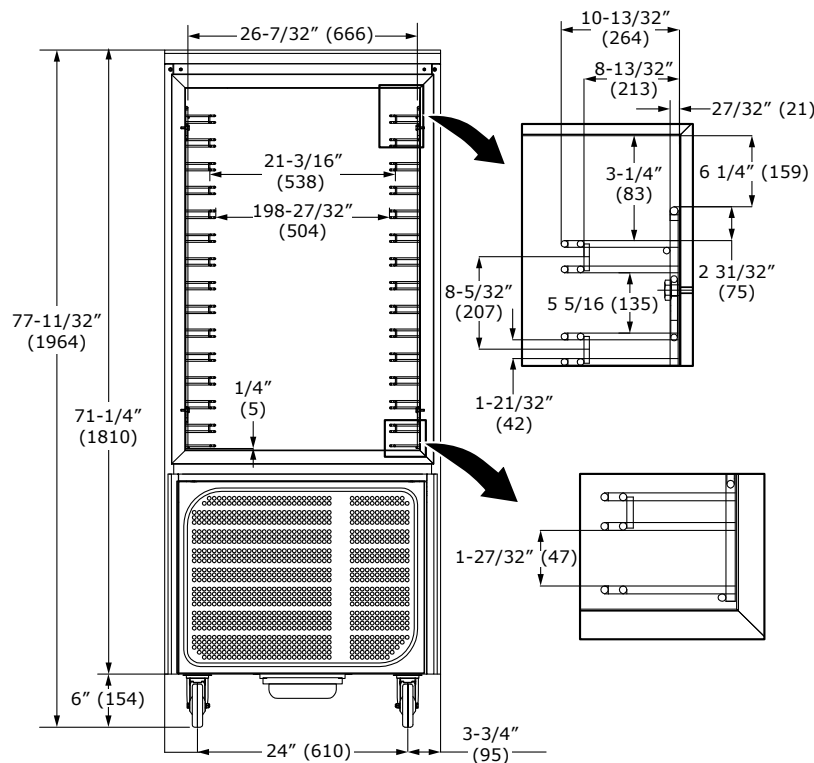

Figure 1: Front View of Dimensions

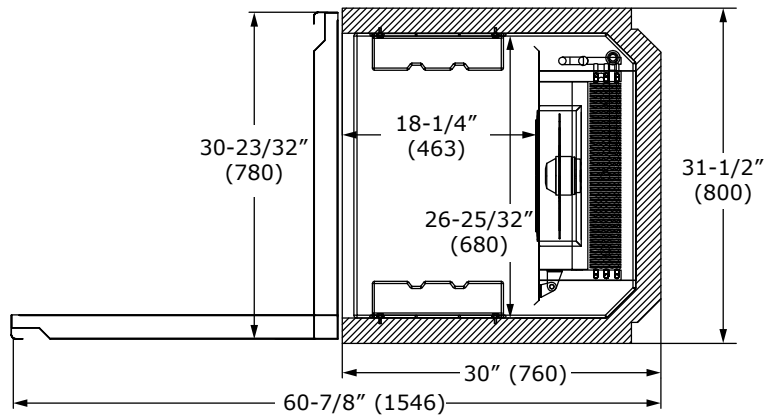

Figure 2: Top View of Dimensions

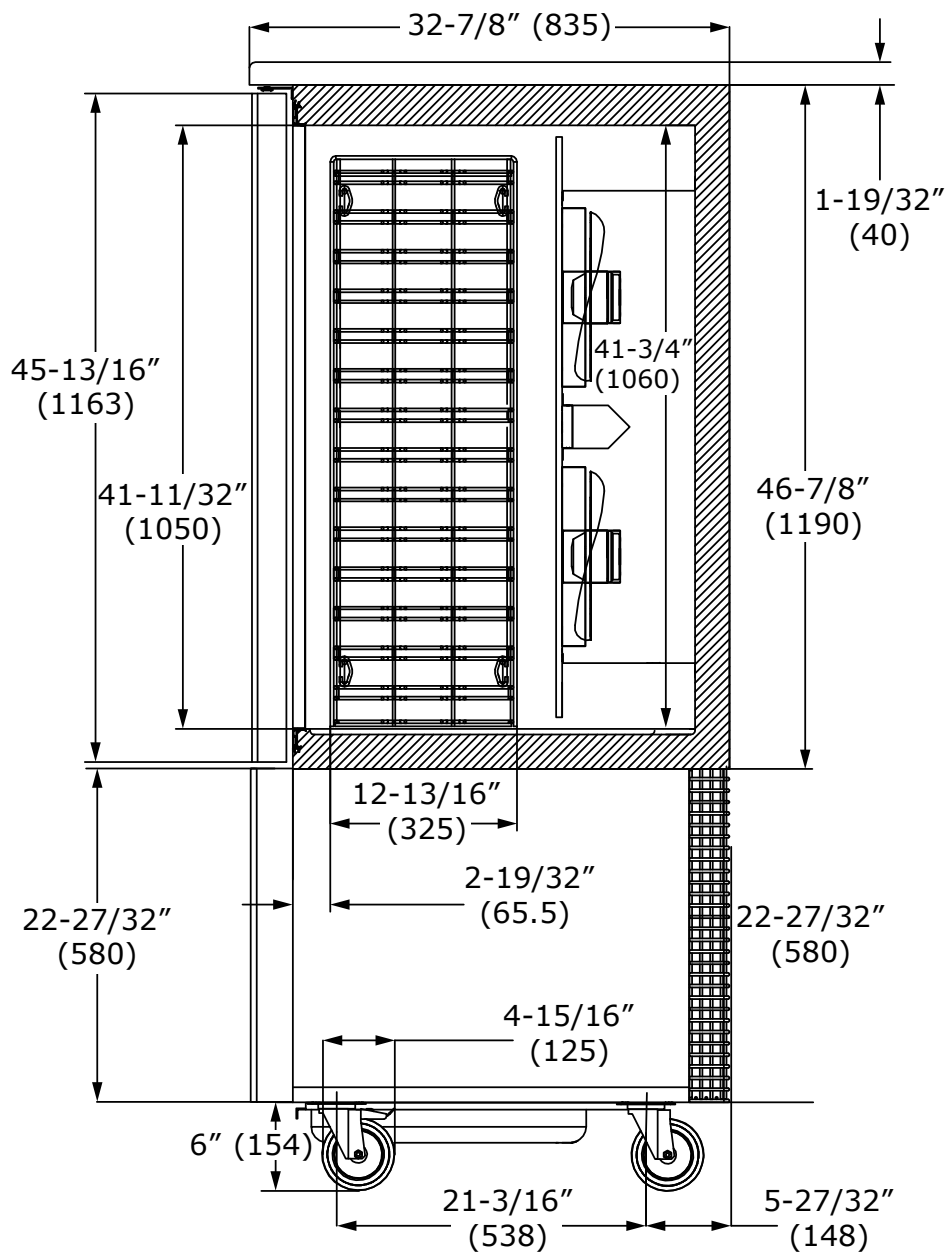

Figure 3: Side View of Dimensions

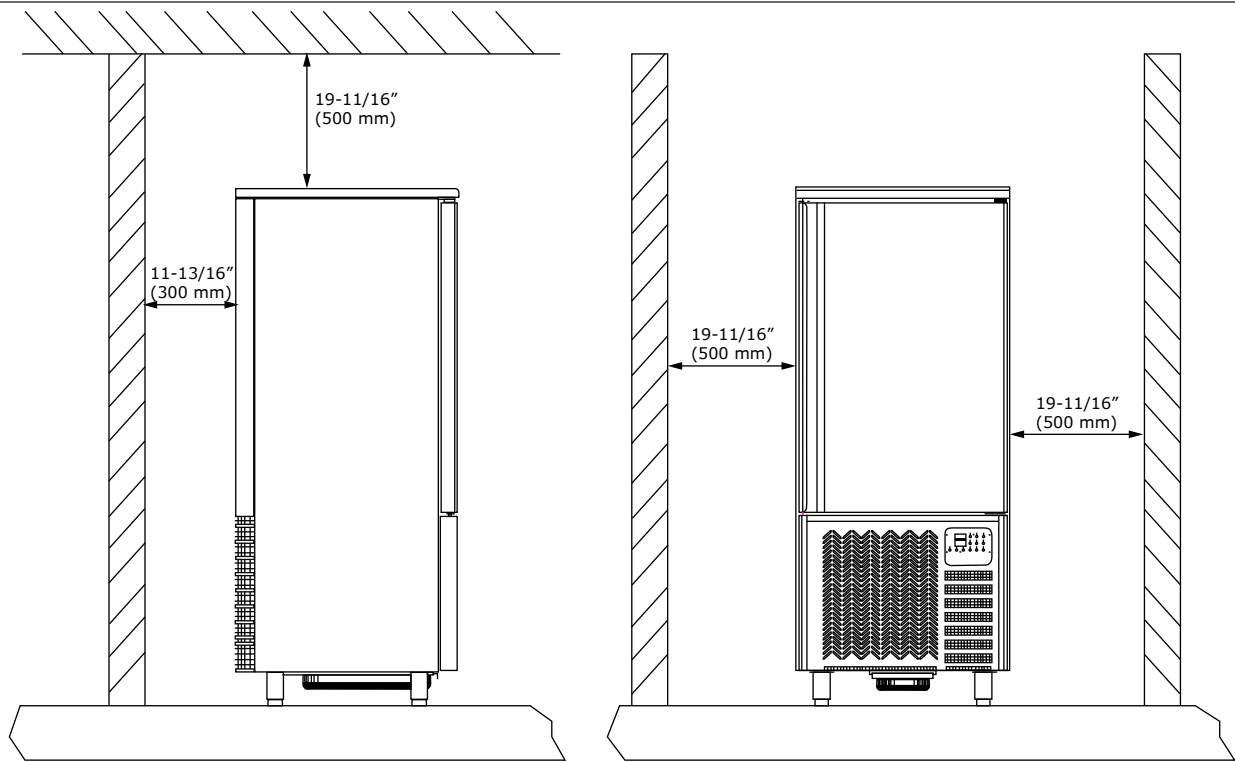

Figure 4: Required Clearance

## Remote—Air Flow Requirements

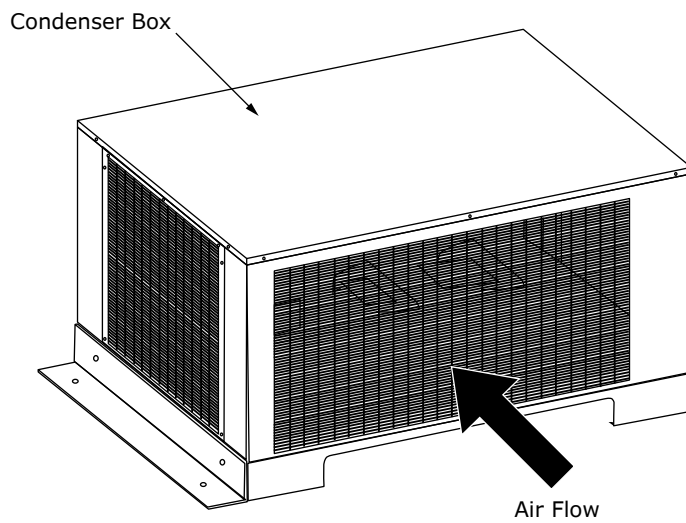

Figure 5: Required Air Flow for Condenser Box

# USER GUIDE

## Installation Requirement

In most of the cases the condenser box is installed in a false ceiling. Better than a minimum clearance, an extraction fan is recommended for those ambient where the temperature may exceed 110°F (43°C) (see Figure 6 and Figure 7).

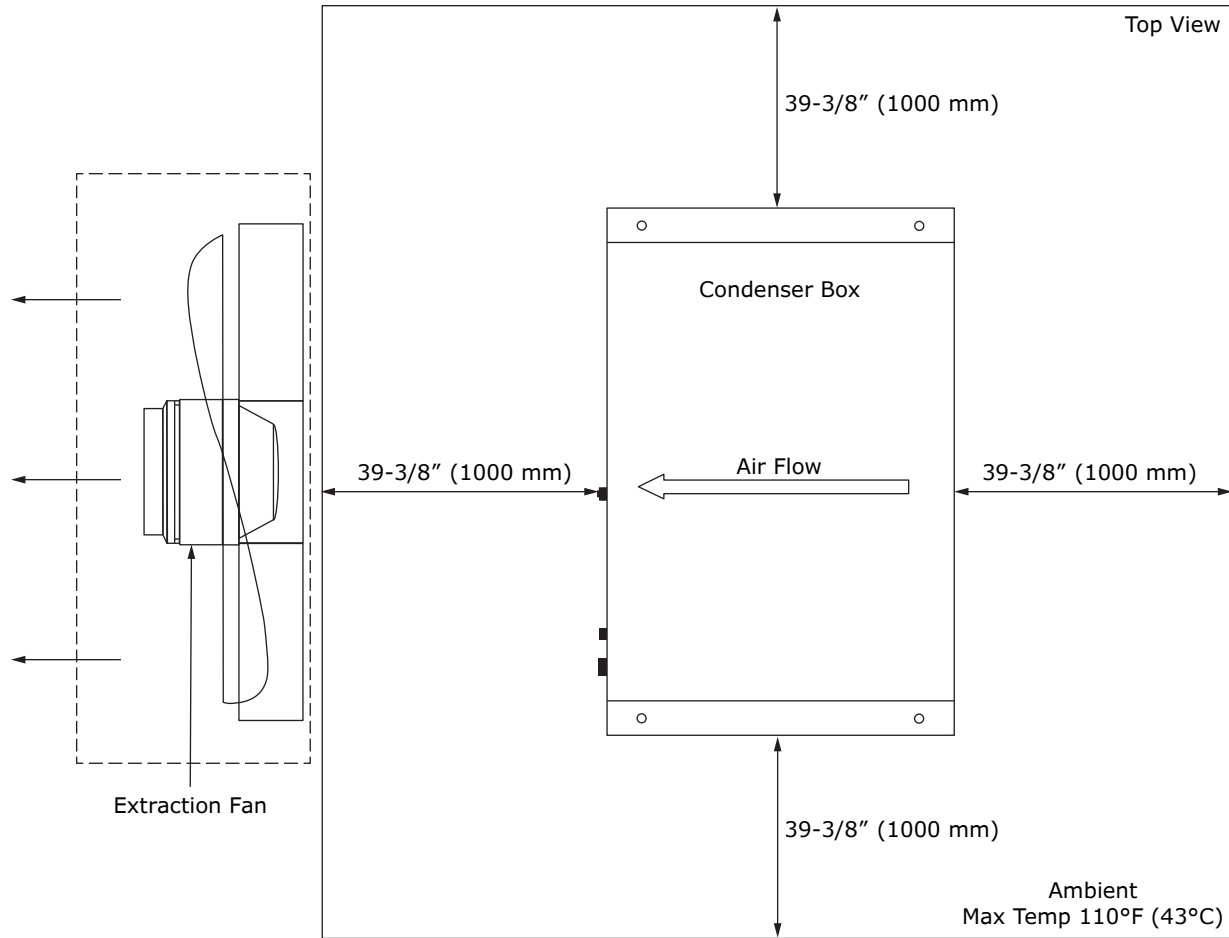

Figure 6: Top View with Extraction Fan

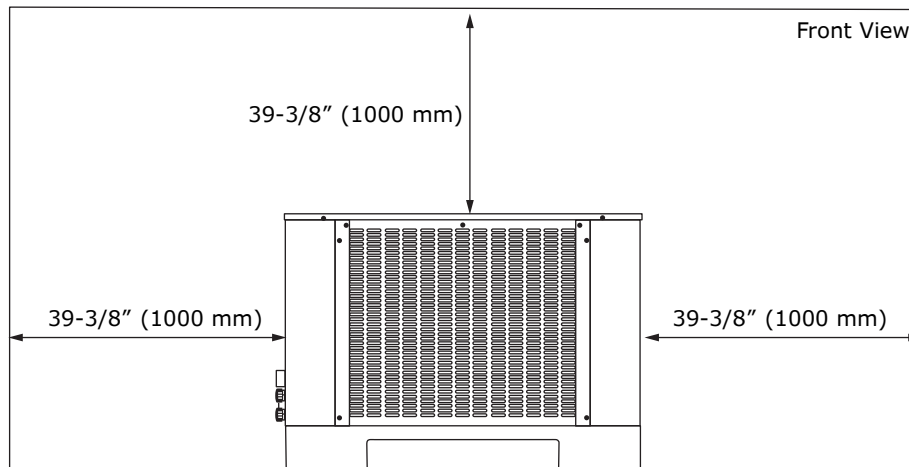

Figure 7: Front View with Extraction Fan

## General Installation

### **WARNING**

**Improper installation, adjustment, alteration, service or maintenance can cause property damage, injury, or death.**

### **WARNING**

**Incorrect installation or any modifications made to the appliance may damage property or result in injury or death.**

### **WARNING**

**Appliance maintenance must be carried out by only by suitably trained personnel.**

### **WARNING**

**All replacement parts that are not supplied by U-Line must be preapproved before installation.**

### **WARNING**

**Before any maintenance work is performed, the appliance must be disconnected from the electrical supply. Apply a lockout tag to the electrical supply connection.**

## PERSONNEL

Staff who use and install the appliance must possess (or acquire through adequate training) the following skills and must understand the Manual instructions and all relevant Safety information:

- General technical knowledge to understand the Manual's instructions
- Awareness of the main hygiene, accident prevention, and technological regulations

## PUTTING INTO OPERATION

If the equipment has been placed in a horizontal position during transport, it cannot be put in operation immediately. Put the unit in a vertical position, then wait about two (2) hours to operate it.

## SET UP

Initial startup requires no adjustments. If the unit was turned off, press  to turn unit on. See "Control Operation" section for more details.

### **NOTICE**

**Temperature displayed reflects actual temperature inside unit.**

**If the temperature displayed is different than selected, the unit is progressing towards the selected temperature. Time to reach set point varies based upon ambient temperature, temperature of product loaded, door openings, etc. U-Line recommends allowing the unit to reach set points before loading.**

To continue to set up the unit, perform the following steps:

1. Remove the packaging from the refrigerator. Assess the area:
  - if the vertical space is high enough, lift the box up
  - if the vertical space is not high enough, cut away the cardboard in sections and pull them away

**NOTE: Make sure the unit stays vertical.**

2. Remove the white PVC protection film from the stainless steel and all other protection used by the company to reduce the risk of damage during transport
3. Place the refrigerator on a flat level surface.
4. Before use, clean the refrigerator with a clean, soft cloth and appropriate spray product.

**NOTE: Use minimal water because it contains minerals that leave traces of dirt, which are difficult to remove.**

5. Wash the tray and all internal parts, using commercial anti-bacterial detergents.
6. Remove the detergent with a soft sponge soaked in water and dry with a clean, soft cloth.

**NOTE: Do not use abrasive detergents or powders, which could cover the finish with a film.**

# USER GUIDE

---

**NOTE: Use minimal water for cleaning. Too much water can damage electric parts; a damp sponge is sufficient.**

7. Install the shelf supports where needed.
8. Insert each support into the holes at the base of the refrigerator.
9. Insert the side tab in the appropriate place on the sides or on the table supports.
10. Slide the shelf into the supports.

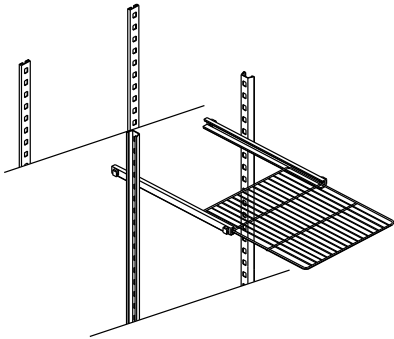

*Figure 1: Shelf Sliding into Supports*

11. On the lower part of the refrigerator, slide the condensation waste tray into the appropriate runner.

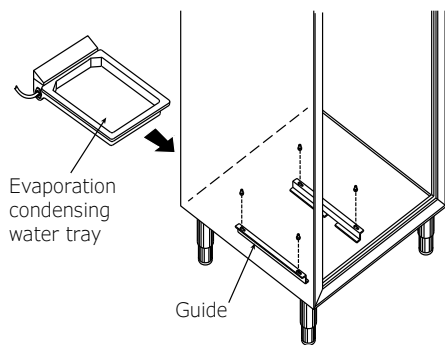

*Figure 2: Tray Guides*

12. For appliances that have automatic trays, connect the connector.

See the "Cutout and Product Dimensions" and "Control Operation" sections for more details.

## Control Operation

### POWERING UP THE TOUCH SCREEN CONTROL

To begin on the Stand-By screen, press and hold the Power Button for 5 seconds (see Figure 1), until you see the Status Bar move to the right and it says "Please wait".



Figure 1: Stand-by Screen

After control is initialized and the software begins to load, allow 15 seconds for it to complete.

From the Home screen, select CHILLING, FREEZING, or MORE (see Figure 2). To turn off the controller, press the ON/OFF button on the bottom right side.



Figure 2: Home Page

### THE BLAST CHILLING MODE

The Blast Chilling function allows you to quick chill food down to 37°F (3°C), using a probe, in 90 minutes or less, provided that:

- the total product weight matches the Blast Chiller Specification
- the initial temperature is lower than or equal to 195°F (90°C)
- the product thickness is less than or equal to 2 inches (5 cm)
- the food is evenly distributed in the chamber

- a pre-chill initial step is done to improve the chiller performance in the heaviest conditions

### Product temperature before and after a Chilling Cycle

To comply with HACCP regulation, the target internal temperature at the end of the cycle is 37°F (3°C) and cannot be changed. The starting temperature of the food products can vary depending on the cooking, or finishing, process which the food originally went through. For example, chicken has a higher internal temperature while pizza dough begins at a lower internal temperature.

### Air Temperature

The air temperature is the temperature of the cabinet where the food is being chilled. The range for a Blast Chilling process is from -13°F (-25°C) to 48°F (9°C) degrees and the holding range is from 14°F (-10°C) to 50°F (10°C).

### Time or Temperature based Cycles

Use automatic (select food icons) or manual mode to chill items. Depending on the mode and options selected, choose to chill items by time, or by using the food probe to set core temperature.

If time mode is selected, the Blast Chilling cycle terminates by elapsed time. The product may or may not reach the desired core temperature.

In food probe mode, the food probe controls the Blast Chilling and may take more or less time. This time varies based on the product weight, density, thickness, starting temperature, etc., to reach the target temperature.

In either mode, after the time has elapsed or the food probe temperature is reached, the machine switches to hold mode automatically and maintains the product at the storage temperature. Determine which mode you prefer, based on your knowledge of food temperatures and the time allotment. Select a core temperature-based cycle that gets the food temperature to match food safety guidelines at 37°F (3°C), before entering hold mode.

### Automatic Defrost

Evaporator defrosts automatically between the chilling and hold modes, and stops after the ice on the evaporator is melted.



## Blast Chilling Cycle Activation

When CHILLING mode is selected, the machine automatically pre-chills the cabinet to 23°F (-5°C) (see Figure 2). After reaching the pre-chill temperature, the manual cycle, or recipe, can be started.

Press the green arrow (Play) to go directly to the recipe selection screen and skip the pre-chill cycle.

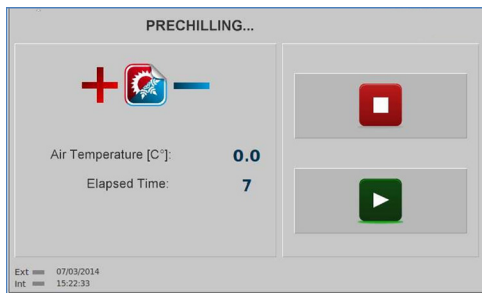

Figure 3: Pre-chilling Screen

Select the appropriate food category or manual cycle.



Figure 4: Food Categories Available

## Blast Chilling Automatic OEM Recipes

The pre-programmed recipes do not require cycle setting. These recipes come with pre-determined settings that give the best chilling process for the selected type of food (see Figure 4).

Every recipe has four categories to suit variations of the selected food.

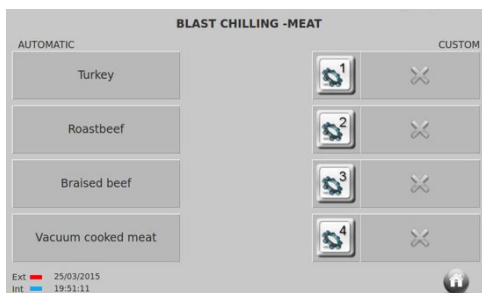

Figure 5: Meat Chilling Recipe Options

The pre-programmed Meat Recipe categories are set up for different proteins. Press the desired button (buttons on the left side of the screen), which immediately starts the cycle (see Figure 5).

The Food Probe Insertion screen appears.

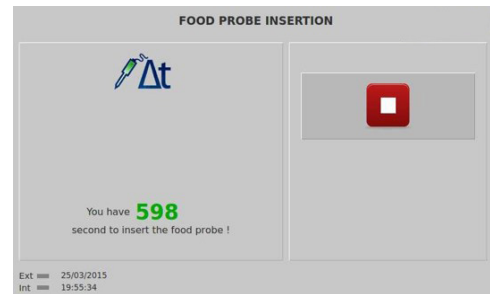

Figure 6: Food Probe Insertion Screen

**NOTE: When selecting an automatic recipe, you must use the food probe.**

A time counter runs until the needle probe is inserted in the food. The electronic system recognizes the probe insertion and initiates the cycle (see Figure 7).



Figure 7: Cycle Initiated

The Blast Chilling in Progress screen appears. A graph shows the food core temperatures (from the food probe) and the air temperature in real time. The right side of the display shows the food selected, the type of cycle (Chilling or Freezing icon), and the fan speed. The bottom of the display shows real time values and cycle setpoint values, which appear from left to right:

- Food °F – Current core temperature (it takes the warmest value)
- Air °F – Current air temperature
- Time min. – Elapsed time
- End cycle °F – Food target temperature in an automatic recipe. When core temperature is reached, the cycle switches to the next step

# USER GUIDE

- Air set °F – Desired air temperature of the current step
- End cycle min. – Time the cycle will end (e.g., three dashes indicates a core temperature-based cycle, so time is not available)
- Food scan – Status of the four core temperatures.

The system monitors the four cores of the food thickness in the first five minutes of the cycle. Cores can be excluded from the algorithm, which means the food measured with the excluded will not be measured. The warmest core will determine the end of the total cycle 37°F (3°C). Each core contributes to regulate the internal cycle's steps, varying the air set temperature and fan speed. The following indicators show core status:

- Blue – Warmest core
- Green – Core is positioned in the food thickness
- Grey – Excluded core

While scanning the food, the cycle runs through four steps with different settings. The goal is to chill the food in the shortest possible time, while saving the product integrity. For example, a piece of cooked meat with an internal temperature of 90°C (194°F) runs through the initial step at very low temperature. The meat reaches the highest air temperature at the end to prevent freezer burn. Conversely, bread is chilled at a warmer air temperature (above the freezing point) from the start, in order to not affect the product surface.

**NOTE: Automatic OEM recipes are set up in the factory and guarantee the best combination of steps for a chilling cycle.**

## Blast Chilling Manual Program

Press the Manual button on the Food Selection screen (see Figure 4).

The Manual Program screen appears (see Figure 8). To set the time, press the TIME button and set the time of the cycle. Press the AIR TEMPERATURE button to set the cabinet air temperature. Push the FAN speed button to set the fan speed—the default is always High or 10. Press the HOLD TEMPERATURE button to set the temperature at the end of the cycle. Press OK to start the cycle.

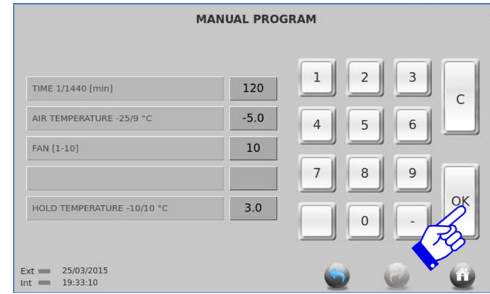

Figure 8: Manual Program Screen

## Blast Chilling Custom Recipes

Every food category (icon) allows the creation of four custom recipes (press the Gear icon on the screen) (see Figure 5). Custom configuration allows you to choose the core probe option, the cycle time length (if the core probe is not selected), the air temperature, the fan speed, and the air temperature for the holding cycle. To disable or enable the food probe, press the green check mark or red X.

**NOTE: Similar to the Manual Program, the custom configuration is related to a food category (icon).**

Press the TIME (1/1440 min), AIR TEMPERATURE -25/9°C, FAN (1-10), and HOLD TEMPERATURE -10/10°C buttons to enter the correct values (see Figure 9).



Figure 9: Updating Values

Pressing the button for a specific mode highlights it in blue (see Figure 10).

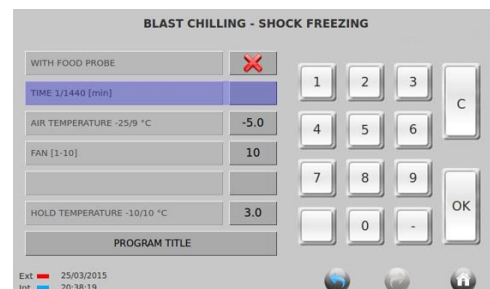

Figure 10: Blue Highlight

# USER GUIDE

Type the correct range for each mode.

If the chosen option is outside the range, or not applicable, that mode is highlighted in red. If any mode is in red, select a valid number within the range (see Figure 11).



Figure 11: Red Highlight

After all modes are set up, press the PROGRAM TITLE button to name the custom recipe (see Figure 12).



Figure 12: PROGRAM TITLE Screen

Press the TITLE button, which highlights the button in green (see Figure 13). Name the program.



Figure 13: TITLE Field Highlighted

Press the DESCRIPTION button to add information to that recipe (see Figure 14). Press Ok to start the cycle.



Figure 14: DESCRIPTION Field Highlighted

If you select probe mode, the screen prompts you to insert the probe. The system displays a 10-minute countdown (shown in seconds) to insert the probe (see Figure 15). The system recognizes the probe immediately after it is inserted, and starts the process.

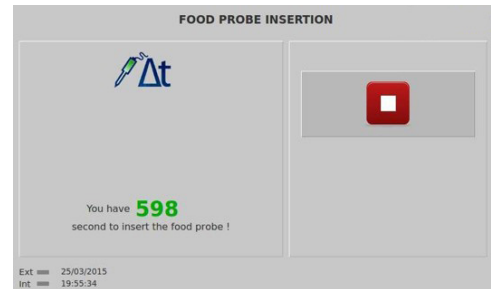

Figure 15: Blast Chilling Cycle Screen

**NOTE: Manual Programs and the Custom Recipes do not provide the same advantages of the Automatic OEM Recipes. However, these programs allow a one single step chilling process during all the cycle—where air temperature and fan speed are always the same value.**

## Cycle Graph and other functions

For an automatic or manual cycle, the graph shows the air set temperature, actual air temperature, and set temperature during a chilling or freezing cycle. The timer counts up until it reaches the cycle set time or until the target temperature is reached (when using the insert probe). After the set time or temperature is reached, the unit switches to hold mode, which can be stopped at any time by pressing the stop button (see Figure 16). If the doors are opened, the fans and compressor turn off. The compressor has a one minute delay on start up.



Figure 16: Hold Mode Screen

If the graph is touched while the BLAST CHILLING IN PROGRESS cycle is in progress, a parameters screen appears (see Figure 17). Select which temperature value is used by enabling or disabling the green checkmarks.



Figure 17: Blast Chilling Cycle Screen

Press the PARAMETERS icon to check all the control parameters settings. On the PARAMETERS 1/4 screen, parameters cannot be changed and are for reference only (see Figure 18). Press the Return icon to return to the previous screen.



Figure 18: Parameters Screen

Press the ALARM button to display any alarms that occur during the cycle (see Figure 19).

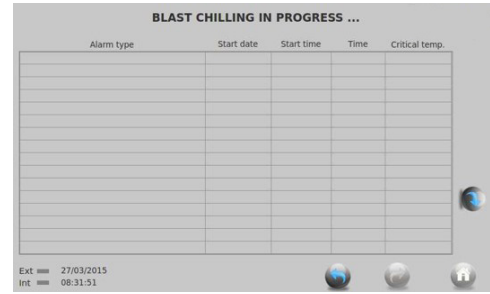

Figure 19: Blast Chilling Cycle Alarm Screen

Press the I/O (Input/Output) button to monitor the probe readings (input values) in real time, including the four insert probe cores, and the door status. Additionally, the I/O function shows output values (see Figure 20).



Figure 20: Output Values from I/O Functions

Use the ENERGY button to monitor the actual voltage, absorption power, etc.

## Cycle End

When the cycle is complete, the CYCLE ENDED screen appears. The flag icon shows the exact time the target was reached (see Figure 21).

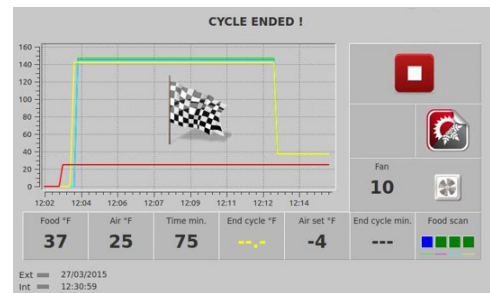

Figure 21: Checkered Flag for Target Reached

## Automatic Holding Cycle

The Holding mode starts automatically (see Figure 22). From left to right, the screen displays the following parameters:

- High limit – upper temperature limit to trigger a high temperature alarm

# USER GUIDE

- Air °F – current temperature during the chilling mode
- Consumption W – energy usage at this time
- Low limit – low limit to trigger a low temperature alarm
- Air set °F – set air temperature for the holding cycle
- Time min. – time elapsed during the holding cycle
- Defrost – unit is in defrost

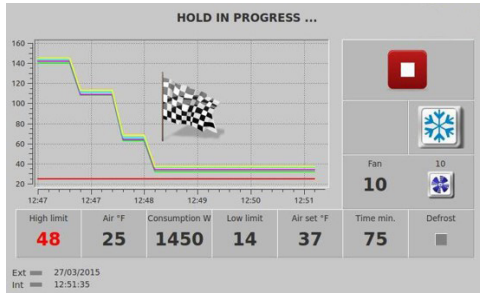

Figure 22: Automatic Holding Cycle Screen

Press the red stop button to stop the holding cycle and return you to the Home screen.

## The Blast Freezing Mode

The Shock Freeze cycle (FREEZING button) is identical to the Blast Chilling cycle (CHILLING button) regarding programming, operation, and modes. These two cycles have the following exception: they run at lower temperatures and hold at lower temperatures. The pre-determined food target temperature in a freeze cycle is 0°F (-18°C) and HACCP states that this temperature should be reached within 240 minutes. The air temperature can be set at a minimum of -40°F (-40°C). For the CHILLING and FREEZING buttons, select a probe-based cycle (food at the correct temperature at the end of the cycle) or a time-based cycle (switches to the holding mode after a given time regardless of the food temperature) (see Figure 2).

## THE OTHER SCREEN (MORE)

Access the OTHER screen via the MORE button.

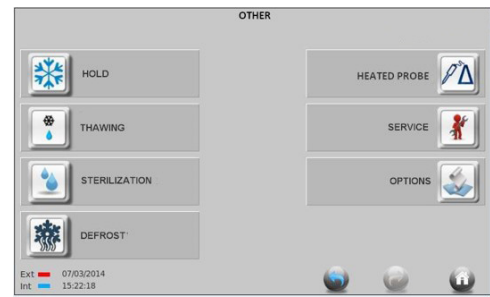

Figure 23: OTHER Screen

The OTHER screen allows you to do any of the following actions (see Figure 23):

- HOLD – put the chiller in Hold-only mode
- THAWING – start the Thawing cycle (if applicable)
- STERILIZATION – activate a UV Lamp Sterilization cycle (if applicable)
- DEFROST – start a Manual Defrost Cycle
- HEATED PROBE – turn on the Optional Heated Probe
- SERVICE – access the Service menu
- OPTIONS – access the Options menu

### Hold

To select the HOLD option, press the HOLD button (see Figure 23).

Press the AIR TEMPERATURE -40/48 °F button to change the hold temperature. The button turns blue and you can select a temperature from -40°F (-40°C) to 46°F (8°C). If the air temperature is outside the range, or not entered, that button is highlighted in red. If it is red, select a valid number within the range (see Figure 24).

Type the temperature and press OK to start the cycle.

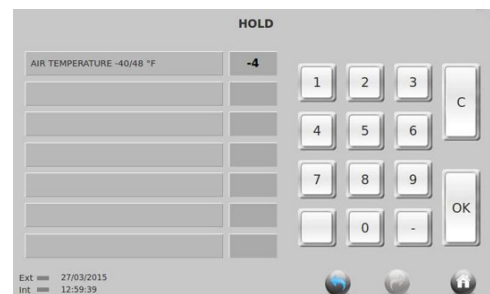

Figure 24: Type Temperature Parameters for Hold

A graph with the title HOLD IN PROGRESS appears during the HOLD cycle (see Figure 25).

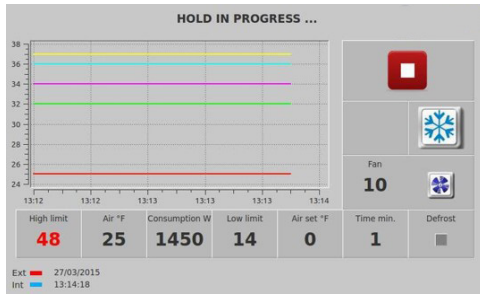

Figure 25: HOLD IN PROGRESS Screen

This cycle runs until it is stopped manually by pressing the red stop button.

## Thawing

The THAWING function provides mild heating in the cabinet with a low fan speed and a special heating system, allowing quick thawing of a frozen product (see Figure 23).



Figure 26: Initial THAWING IN PROGRESS Screen

The air temperature can be set between 32°F (0°C) and 48°F (9°C) (see Figure 26). The insert probe can run a product temperature-based cycle and obtains a notification from the display when the product is ready to rethermalize [i.e., -37°F (3°C)] (see Figure 27). If necessary, set a time-based cycle to run the thawing process for a predetermined time.

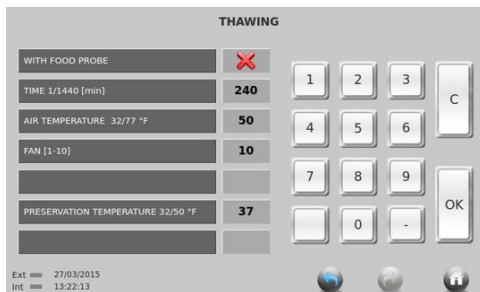

Figure 27: Set Parameters for Thawing



Figure 28: Blast Chilling Cycle Screen

## Manual Defrost

Press the DEFROST button to select Manual Defrost from the OTHER screen (see Figure 23).

The Manual Defrost cycle is programmed to run for 10 minutes or until the evaporator temperature reaches 46°F (8°C).



Figure 29: Defrosting Cycle Screen

The fans run at high speed for the air defrost cycle. After Manual Defrost is complete by time or temperature, the screen returns automatically to the Home screen (terminate it at any time by pressing the red stop button).

## Heated Probe

The Heated Probe function is available upon request and must be installed and activated at the factory. Press the Heated Probe button to activate this function. Press HEATED PROBE option will heat the food probe slightly for one minute, which allows the probe to be removed from the frozen product without damaging it (see Figure 23). After the probe times out, press the red stop button to return to the OPTION screen or push the Home icon to return to the Home screen.

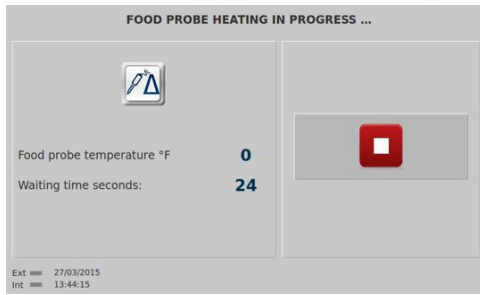

Figure 30: FOOD PROBE HEATING IN PROGRESS Screen

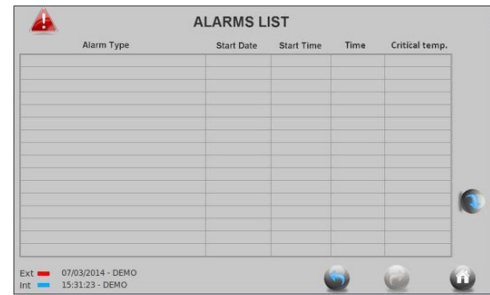

Figure 32: Alarms List

## Options



Figure 31: OPTIONS Screen

The OPTIONS button gives access to the following advanced functions:

- ALARM LIST
- DEFROST LIST
- HACCP
- I/O (Input/Output)
- PASSWORD
- HELP
- LANGUAGE
- DATE/TIME
- USB
- DISPLAY

## ALARM List

Alarm List stores any alarms that occur during operation and is useful for diagnosing an issue with the equipment. This function provides a description of each alarm, and date and time it occurred.

## DEFROST LIST

DEFROST LIST stores any defrost cycles that have occurred during operation. This function provides a description of the defrost cycle, and date and time it occurred.

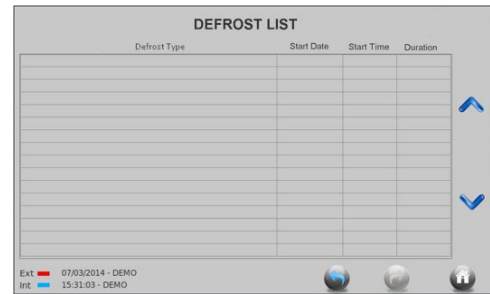

Figure 33: Defrost List

## HACCP List

The HACCP List screen provides you with a graph showing the HACCP data for the cycles made on the selected date. After date is selected (using the European order DD/MM/YY) on the HACCP screen, press SEARCH DATA to display the windows cycle graphs.

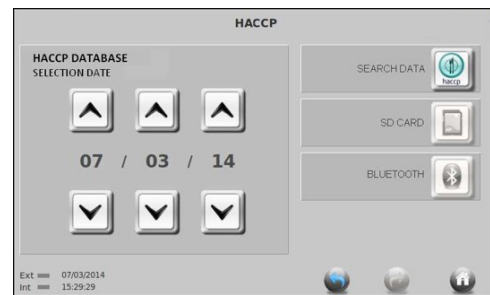

Figure 34: HACCP List

## I/O List

Use the I/O (Inputs/Outputs) menu to check all incoming signals, such as temperature sensors, door switch status, and relay status.

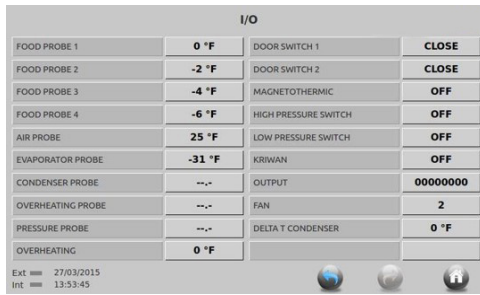

Figure 35: I/O Menu

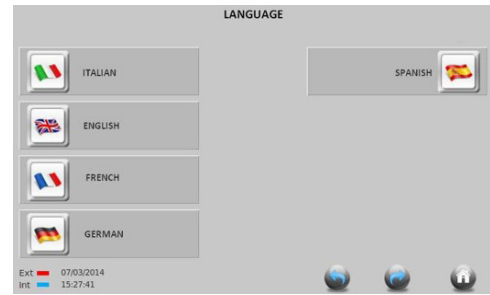

Figure 37: Languages Available on LANGUAGE Screen

## PASSWORD

You can change the password from the factory default (see Figure 31). The chef can also set a password to protect the recipes (see Figure 36).



**If the password is changed or a chef's password is set up, the factory cannot access this control if diagnostic service is required. You must secure the password in a safe place. If the changed passwords are lost, the software must be reloaded and all saved recipes will be lost. To set a new password, select which type of password you wish to enter, ENTRY or CHEF, that tab will be highlighted. Enter the password and press OK. After changing the password, it will be needed to access the programs.**



Figure 36: Changing a Password

## HELP

Use the HELP button to access videos, manuals, parts lists, or maintenance information (see Figure 31).

## LANGUAGE

Press the LANGUAGE button to change the language (see Figure 31). Select one of the following languages: Italian, English, French, Spanish, or German (see Figure 37).

## How to set the time and date

Time and Date settings are important for tracking the HACCP data correctly. Press the Date/Time icon to show the TIME setting screen (see Figure 31).

Set the date using the European model: Day, month, and year (DD/MM/YY). Press the up and down arrows to change the date and time (see Figure 38).

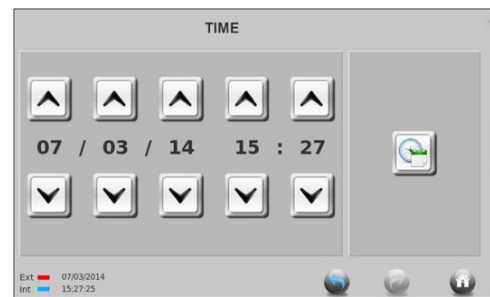

Figure 38: Setting Date and Time

After the date and time is set, press the Return arrow for the Options screen or press the Home icon for the Home screen.

## How to adjust the display

Press the DISPLAY button to adjust the screen brightness, maximum, minimum, and to set the screen saver message (see Figure 31).

Press the button for the settings you need to change, enter a new value, and save it.



Figure 39: Setup Options



# USER GUIDE

Press the Return arrow to return to the Options screen, or press the Home icon to return the Home screen.

## USB functions

Access the USB port from behind the sliding panel frame on the right side of the Touch Screen. Using this port, you can import and export data to/from a USB stick (see Figure 40). This type of USB does not require special hardware; however, an empty formatted USB (flash drive) with a minimum of 2 Gigabytes is recommended (see Figure 31).

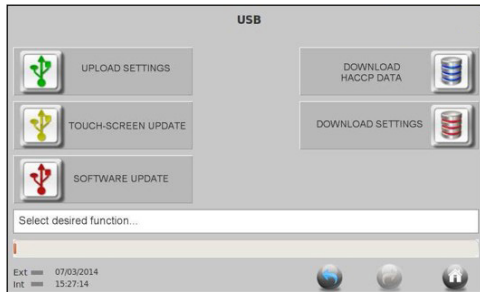

Figure 40: USB Options

The main active USB functions are:

- Touch Screen Update
- Software Update (only software, only parameter, both software and parameters)
- Download HACCP Data

## DOWNLOAD HACCP DATA AND TRACE CYCLE DIAGRAMS

This Touch Screen Controller can export HACCP information to a USB key. Press the related button in the USB menu and the controller will transfer the data to the USB.

The file will be exported as a zipped file named “haccp.zip”. When you connect the USB to a PC, the file will appear as a zipped file in a style similar to those seen in Figure 41)



Figure 41: Different Zipped File Icons Displayed

The icon depends on the zip software installed on the PC. Use any zip software (such as PKZIP, unzip, winrar, G7, or similar) to extract the file to a folder (see Figure 41).

The folder will be named “haccp” as well. Cycle data is stored at the following path: haccp\home\root\haccp and is contained as .csv files (Comma Separated Values) (see Figure 42). CSV files are associated with Excel:

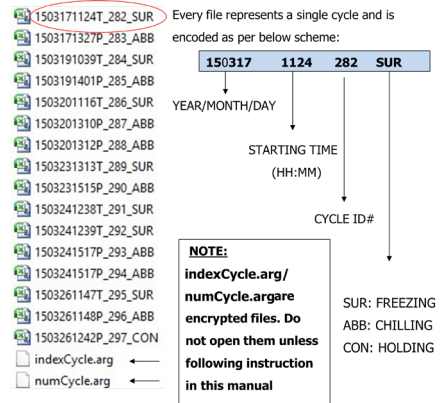

Figure 42: File Types

## Using a Proprietary Software to trace HACCP data

Load and trace the .csv files via a proprietary software called Blast Chiller Tracer. Your customer service representative has the following necessary files:

- ICON db (folder)
- lib ICON (folder)
- ICON BlastChillerTracer (Java executable file)

These files can be stored anywhere on your PC, but all files must stay in the original folder.

### NOTE: Do not open db and lib folders. Only run BlastChillerTracer.

The Tracer is a Java executable file. Java virtual machine (JVM) is normally preinstalled on a Windows-based OS, to run games or other graphical interactive application. When Java is on the PC, the file BlastChillerTracer links to the program via the JAVA icon automatically. If this does not happen, install JVM.

Contact your Administrator or install the JVM directly from the following link: <http://www.java.com/it/download/>

JVM is safe and free of charge. Once it is installed, run the executable file BlastChillerTracer—it has a .jar extension. The main window appears.

Click OPTIONS to adjust settings.

Select the language and scale of temperature, press Set to confirm and exit.

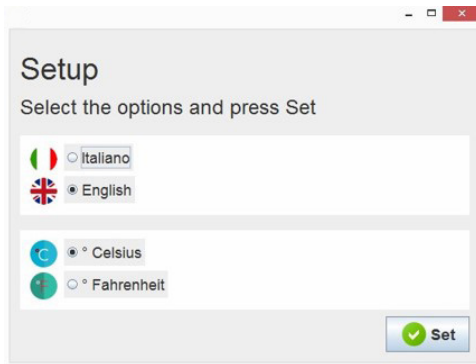

Figure 43: Setup Options

Press the Load File tab on the right top of the screen (see Figure 43).

A file window appears, allowing you to find the file `indexCycle.arg` in the `haccp` folder. This is the folder extracted from the `haccp.zip` file downloaded from the USB Touch Screen (see Figure 44). Click on the folder name to go to the path `haccp\home\root\haccp`

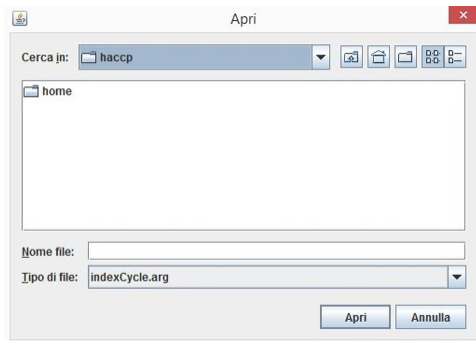

Figure 44: Home Folder

After the `.arg` files appear in the box, double click on `indexCycle.arg`

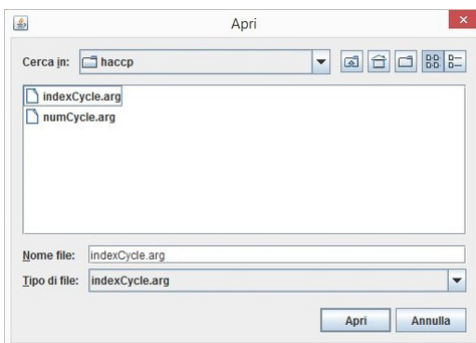

Figure 45: Files Display Box

Select the cycle to graph from the Load file column, based on the date, starting hour and cycle code (see encoding scheme). See an example of cycle graph in Figure 48. Right click on the graph to print or save a `.png` file. Scroll up or

down to zoom in and out. To zoom in a specific area of the graph, just select the area with the mouse.

### Access the source HACCP files for own purpose

The tracer software is a powerful tool that can graph the cycles stored in the Blast Chiller memory. However, it is possible to open the `.csv` source files to check data (see Figure 46). Access the `.csv` files directly from the `haccp` extracted folder. Open the desired cycle with Excel or an equivalent spreadsheet software. The data appears similarly to this table:

	A	B	C
1	2,60315E+11	53.1	40.4
2	2,60315E+11	59.4	51.4
3	2,60315E+11	60.3	55.1
4	2,60315E+11	60.5	56.5
5	2,60315E+11	60.1	57.2
6	2,60315E+11	59.8	57.4
7	2,60315E+11	59.4	57.2
8	2,60315E+11	59.1	57.1
9	2,60315E+11	58.8	56.9
10	2,60315E+11	58.4	56.6
11	2,60315E+11	58.1	56.4
12	2,60315E+11	57.6	56.1
13	2,60315E+11	57.2	55.6
14	2,60315E+11	56.8	55.3
15	2,60315E+11	56.4	55.0
16	2,60315E+11	56.1	54.7
17	2,60315E+11	55.7	54.4
18	2,60315E+11	55.3	54.1
19	2,60315E+11	54.9	53.7
20	2,60315E+11	54.5	53.3
21	2,60315E+11	54.2	53.0
22	2,60315E+11	53.8	52.7
23	2,60315E+11	53.4	52.3
24	2,60315E+11	53.0	52.0
25	2,60315E+11	52.8	51.7

Figure 46: Data Displayed

Data at column A represents date/hour/minutes/second. Change the cell format to "Number" to show the time properly (see Figure 47). Reduce decimal places to 0.

	A	B	C	D	E	F	G	H	I
1	260315114853	53.1	40.4	35.6	17.0	-5.9	1	0	0
2	260315114903	59.4	51.4	48.0	35.6	-5.6	1	0	0
3	260315114913	60.3	55.1	53.0	45.3	-5.6	1	0	0
4	260315114924	60.5	56.5	55.5	50.9	-5.7	1	0	0
5	260315114933	60.1	57.2	56.6	54.1	-6.0	1	0	0
6	260315114943	59.8	57.4	57.4	55.9	-6.3	1	0	0
7	260315114953	59.4	57.2	57.5	57.0	-7.0	1	0	0

DD/MM/YY
HH/MM/SS
FOOD PROBE
FOOD PROBE
FOOD PROBE
FOOD PROBE
AIR PROBE
NOT USED

Figure 47: Types of Data Defined

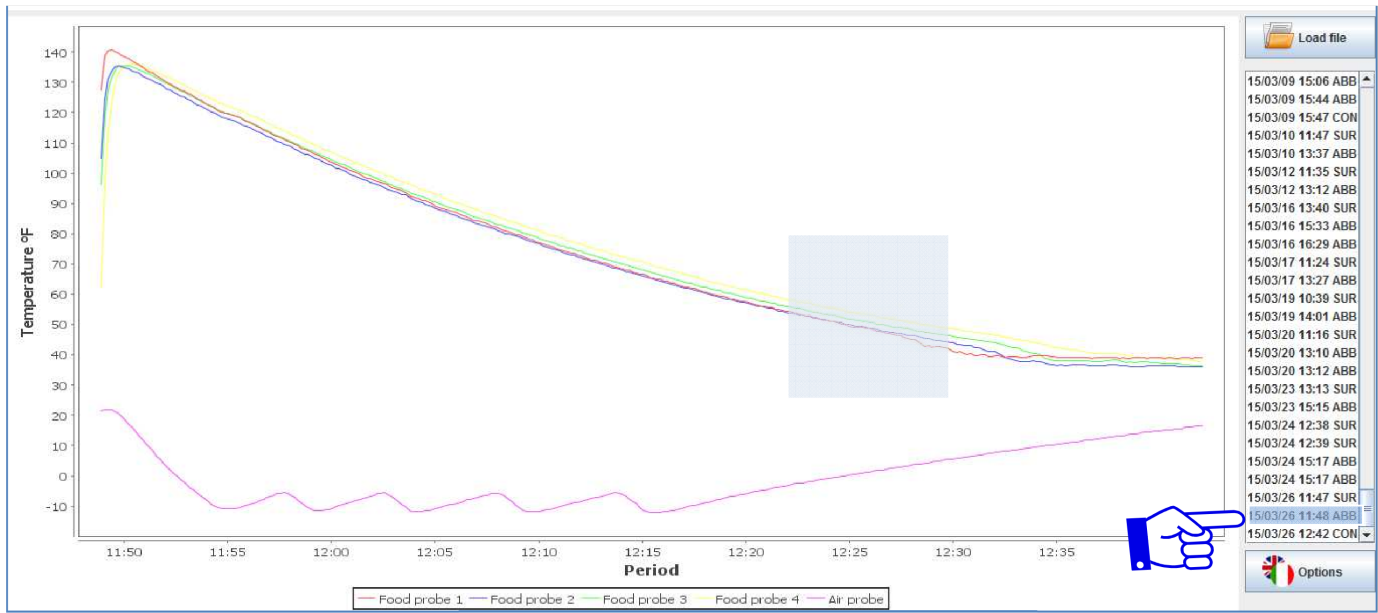

Figure 48: Cycle Graph

## Interior Adjustments

### BRACKETS

#### Interior Pans and/or Trays

Units have permanent racks that do not need to be installed, removed, or adjusted. These racks support trays at regular intervals.

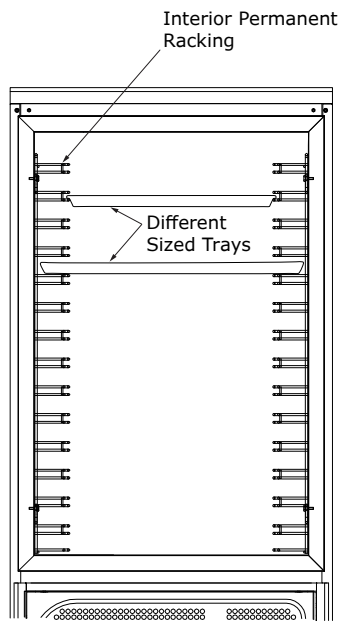

*Figure 1: Permanent Interior Racking with Trays*

## Cleaning

### STAINLESS STEEL SURFACES

Do not expose stainless steel door panels, handles, and frames to chlorine gas, pool chemicals, saltwater, or cleaners with bleach. These agents can discolor stainless steel surfaces.

Keep your stainless steel unit looking new by cleaning with a good quality food-grade stainless steel cleaner and polish monthly.

**NOTE: Do not clean with steel wool pads.**

**NOTE: Do not use cleaners not specifically intended for stainless steel on stainless steel surfaces (this includes glass, tile, and counter cleaners).**

**NOTE: Do not use abrasive pads, such as ScotchBrite™, they will cause the graining in the stainless steel to become blurred.**

**NOTE: Rust not cleaned up promptly can penetrate the surface of the stainless steel and complete removal of the rust may not be possible.**

### CLEAN INTERIOR COMPONENTS

Use warm or hot water with a food-grade cleaner to clean all removed components and interior surfaces.

### CLEAN EXTERIOR SURFACES

The following guidelines are recommended for cleaning external parts and surfaces:

- Cleaning products: water and neutral non-abrasive detergents (do NOT use solvents)
- Cleaning methods: waster with a cloth or a sponge
- Frequency: weekly

#### NOTICE

**Do not use any solvent-based or abrasive cleaners. These types of cleaners may transfer taste and/or odor to the interior products and damage or discolor the interior.**

### DEFROSTING

This unit has both automatic and manual Defrost options.

#### Automatic Defrost

See the “Control Operation” section for information on the Defrost option on the control panel.

#### Manual Defrost

#### WARNING

**Do not use medical devices or other means to accelerate the defrosting process other than those recommended by the manufacturer.**

#### CAUTION

**DO NOT use an ice pick or other sharp instrument to help speed up defrosting. These instruments can puncture the inner lining or damage the cooling unit.**

#### CAUTION

**DO NOT use any type of heater to defrost. Using a heater to speed up defrosting can cause personal injury and damage to the inner lining.**

#### NOTICE

**The drain pan was not designed to capture the water created when manually defrosting. To prevent water from overflowing the drain pan and possibly damaging water sensitive flooring, the unit must be removed from cabinetry.**

To defrost the unit manually, perform the following steps:

1. Disconnect power to the unit.
2. Remove all products from the interior
3. Prop the door in an open position (2 in. [50 mm] minimum).
4. Allow the frost to melt naturally.
5. After the frost melts completely, clean the interior and all removed components. (See INTERIOR COMPONENTS).
6. When the interior is dry, reconnect power and turn unit on.

## Cleaning Condenser

### INTERVAL—WEEKLY

#### NOTICE

**Failure to clean the condenser regularly can cause the unit to malfunction. This could void the warranty.**

The efficiency of the condenser unit is compromised by the condenser being blocked. This configuration requires that the condenser is cleaned weekly.

#### WARNING

**Disconnect electric power to the unit before cleaning the condenser.**

Before cleaning the condenser, perform the following steps:

1. Switch off the unit
2. Disconnect electric power to the unit
3. Use an air jet or dry brush with rigid bristles, in a vertical motion, to eliminate the dust and down from the wings

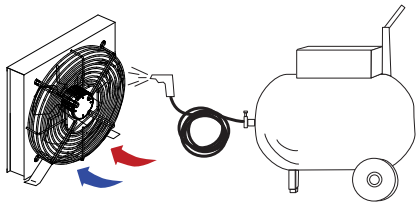

Figure 1: Air Jet Cleaning the Condenser

4. For oily deposits, use a brush soaked in mineral spirits or isopropyl alcohol, or similar. After completing that cleaning process, start the unit normally

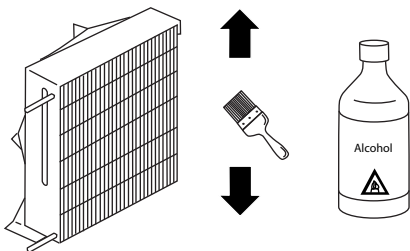

Figure 2: Brush Cleaning the Condenser

#### WARNING

**DO NOT touch the condenser fins. The condenser fins are SHARP and can be easily damaged.**

#### NOTICE

**DO NOT use any type of cleaner on the condenser unit.**

### CLEANING THE CONDENSER FILTER

Clean the removable condenser air filter with an air jet or a vacuum. You can also wash it with warm water, or run it through a dishwasher cycle.

**NOTE: It is recommended to dry it properly after having washed it.**

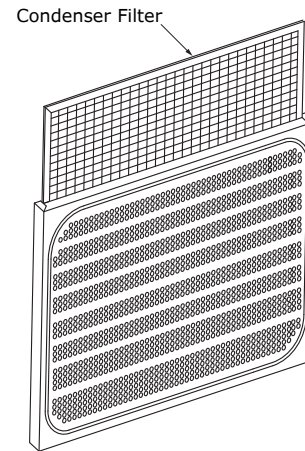

Figure 3: Removing the Condenser Filter

## Extended Non-Use

### PROLONGED SHUTDOWN

The following steps are recommended for periods of extended non-use:

1. Remove all consumable content from the unit.
2. Power the unit down while the Control Panel displays "Standby".
3. Disconnect the power cord from its outlet/socket and leave it disconnected until the unit is returned to service.
4. Clean and dry the interior of the unit. Ensure all water has been removed from the unit.
5. Clean the system. (See the "Cleaning" section)
6. The door must remain open to prevent formation of mold and mildew. Open door a minimum of 2" (50 mm) to provide the necessary ventilation.

### STORAGE

In the case of long periods of inactivity, the upright and/or table refrigerators must be stored with attention to the relevant storage place and time:

- Store the upright refrigerator in an enclosed area
- Protect upright refrigerator from bumps or stress
- Protect upright refrigerator from high thermal variation
- Prevent upright refrigerator from coming into contact with corrosive substances

#### CAUTION

**If the unit will be exposed to temperatures of 40°F (5°C) or less, the "Prolonged Shutdown" and "Storage" steps must be followed.**

#### CAUTION

**Damage caused by freezing temperatures is not covered by the warranty.**

**For questions regarding winterization, please call U-Line at 414.354.0300.**

## Troubleshooting

### **⚠ WARNING**

**Before performing any service that involves electrical disconnection and/or exposure to electrical components, always follow the Electrical LOCKOUT/TAGOUT Procedure. Disconnect all circuits. Failure to comply can cause property damage, injury, or death.**

Perform thorough troubleshooting if the cause of a problem is not obvious. To test the internal components, unplug or remove the unit from the power supply.

### PROBES

The Blast Chiller is equipped with several temperature sensing probes. These probes are Negative Temperature Coefficient (NTC) thermoset sensors (see Figure 1 and Figure 2). The chamber and evaporator probes have the same configuration. The Touch Screen version has a special multicore needle probe (5 cores, but only 4 being read from the board).



Figure 1: Room/Evaporator Probe Type



Figure 2: NTC Needle Probe Types

The needle probe has a different sensing element (see Figure 3). Both types of probes have the same resistance to temperature correlation.



Figure 3: Pt1000 Needle Probe Types (Multicore)

### Checking the Probes

A Probe alarm occurs when something is wrong with the sensor reading. The problem may be either the sensor wires or the sensor itself. Probe alarms Er0, Er1, and Er3 are commonly due to an interrupted (open) circuit in the wires.

Another cause may be a short to the chassis or the two leads shorting together.

To find the cause of the alarm, disconnect the indicated probe and check the resistance between the two wires (or between any of the 5 wires of a multiprobe type).

If the Ohm reading is 0	Probe circuit is shorted between the two wires	Replace the probe
Ohm reading is infinity, $\infty$	Probe is open	Replace the probe
Reading matches the resistance chart at a known temperature	Probe is good	Another problem is the cause
Reading is not 0 or $\infty$ and does not match the resistance chart	Probe is out of range	Replace the probe

If none of the choices is the issue: Ohm out each wire to the chassis. If the reading is 0 or less than  $\infty$ , the probe is shorted to the chassis and must be replaced.

**NOTE: Use a spare probe instead of the suspected one. If the alarm continues, the problem is not the probe.**

Search for additional Probe Alarm issues in the probe to board terminal connection. Check for rust, water, humidity, loosen/lost connections on the probe terminal block (see Figure 4).



# USER GUIDE

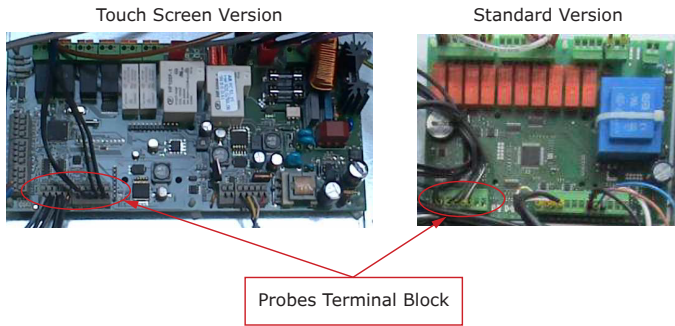

Figure 4: Probes Terminal Block Location

If none of the above causes is found, the problem may exist in the main board internal circuits or in the mother board processor (see Figure 5 and Figure 6). The main board should be replaced.

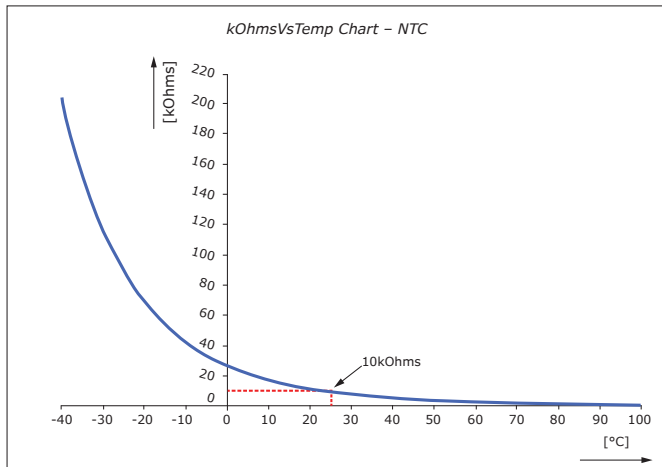

Figure 5: 3.1.2. NTC (10kOhms@25°C/77°F) Diagram

NTC (10kOhms@25°C/77°F) Chart Table

°C	°F	kOhms	°C	°F	kOhms	°C	°F	kOhms
-40	-40	205,20	7	44,6	20,47	54	129,2	3,66
-39	-38,2	193,80	8	46,4	19,63	55	131	3,54
-38	-36,4	183,10	9	48,2	18,83	56	132,8	3,43
-37	-34,6	173,10	10	50	18,06	57	134,6	3,33
-36	-32,8	163,60	11	51,8	17,34	58	136,4	3,22
-35	-31	154,80	12	53,6	16,64	59	138,2	3,12
-34	-29,2	146,50	13	55,4	15,98	60	140	3,03
-33	-27,4	138,70	14	57,2	15,35	61	141,8	2,93
-32	-25,6	131,30	15	59	14,74	62	143,6	2,85
-31	-23,8	124,40	16	60,8	14,17	63	145,4	2,76
-30	-22	117,90	17	62,6	13,62	64	147,2	2,68
-29	-20,2	111,80	18	64,4	13,09	65	149	2,60
-28	-18,4	106,00	19	66,2	12,59	66	150,8	2,52
-27	-16,6	100,60	20	68	12,11	67	152,6	2,44
-26	-14,8	95,51	21	69,8	11,65	68	154,4	2,37
-25	-13	90,69	22	71,6	11,21	69	156,2	2,30

°C	°F	kOhms	°C	°F	kOhms	°C	°F	kOhms
-24	-11,2	86,15	23	73,4	10,79	70	158	2,23
-23	-9,4	81,86	24	75,2	10,38	71	159,8	2,17
-22	-7,6	77,81	25	77	10,00	72	161,6	2,11
-21	-5,8	73,99	26	78,8	9,63	73	163,4	2,05
-20	-4	70,37	27	80,6	9,28	74	165,2	1,99
-19	-2,2	66,96	28	82,4	8,94	75	167	1,93
-18	-0,4	63,74	29	84,2	8,62	76	168,8	1,87
-17	1,4	60,69	30	86	8,31	77	170,6	1,82
-16	3,2	57,80	31	87,8	8,01	78	172,4	1,77
-15	5	55,07	32	89,6	7,73	79	174,2	1,72
-14	6,8	52,49	33	91,4	7,45	80	176	1,67
-13	8,6	50,04	34	93,2	7,19	81	177,8	1,63
-12	10,4	47,72	35	95	6,94	82	179,6	1,58
-11	12,2	45,52	36	96,8	6,70	83	181,4	1,54
-10	14	43,44	37	98,6	6,47	84	183,2	1,49
-9	15,8	41,46	38	100,4	6,25	85	185	1,45
-8	17,6	39,59	39	102,2	6,03	86	186,8	1,41
-7	19,4	37,81	40	104	5,83	87	188,6	1,37
-6	21,2	36,13	41	105,8	5,63	88	190,4	1,33
-5	23	34,53	42	107,6	5,44	89	192,2	1,30
-4	24,8	33,00	43	109,4	5,26	90	194	1,26
-3	26,6	31,56	44	111,2	5,08	91	195,8	1,23
-2	28,4	30,19	45	113	4,92	92	197,6	1,19
-1	30,2	28,88	46	114,8	4,75	93	199,4	1,16
0	32	27,64	47	116,6	4,60	94	201,2	1,13
1	33,8	26,46	48	118,4	4,45	95	203	1,10
2	35,6	25,33	49	120,2	4,30	96	204,8	1,07
3	37,4	24,26	50	122	4,17	97	206,6	1,04
4	39,2	23,24	51	123,8	4,03	98	208,4	1,01
5	41	22,27	52	125,6	3,90	99	210,2	0,98
6	42,8	21,35	53	127,4	3,78	100	212	0,96

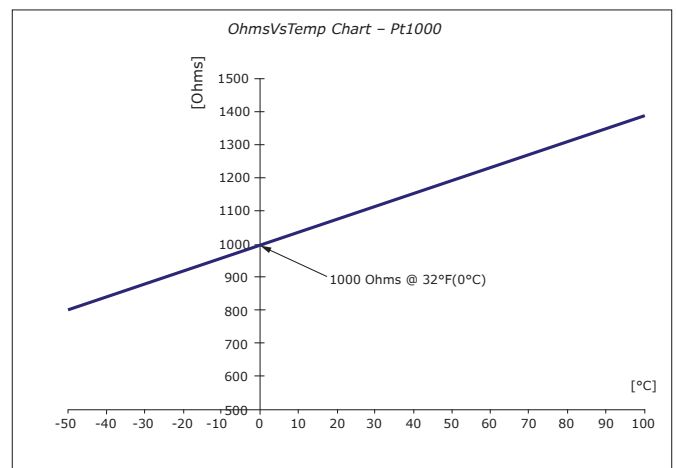

Figure 6: Pt1000 (1kOhms@0°C/32°F) Diagram

°C	°F	Ohms	°C	°F	Ohms
-50	-58	803,10	35	95	1136,10
-45	-49	822,90	40	104	1155,40
-40	-40	842,70	45	113	1174,70
-35	-31	862,50	50	122	1194,00
-30	-22	882,20	55	131	1214,90
-25	-13	901,90	60	140	1232,40
-20	-4	921,60	65	149	1251,60
-15	5	941,20	70	158	1270,70
-10	14	960,90	75	167	1289,80
-5	23	980,40	80	176	1308,90
0	32	1000,00	85	185	1328,00
5	41	1019,50	90	194	1347,00
10	50	1039,00	95	203	1366,00
15	59	1058,50	100	212	1385,00
20	68	1077,90	105	221	1403,90
25	77	1097,30	110	230	1422,90
30	86	1116,70	150	302	1573,10

## DOOR SWITCH

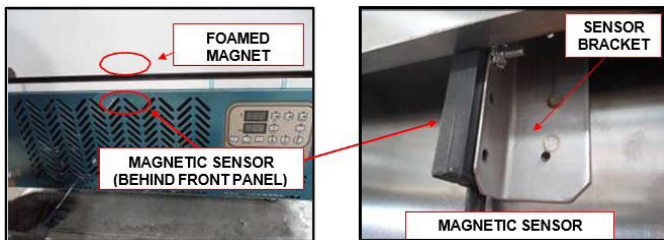

Figure 7: Door Switch

### Checking the door switch

If the magnetic sensor is faulty or if the wires are broken or shorted, the display will show “d-r” continuously. To check the switch, disconnect the wires from the Main Board at terminals 48 and 49 (see Figure 7 and Figure 8). Ohm out the switch between the two wires. Close the switch should be closed when a magnet is present and open it when it is not. If the switch tests OK, check for corroded, loose, or missing connections on the terminals. If no problem is found in the switch or wires, replace the Main Board.

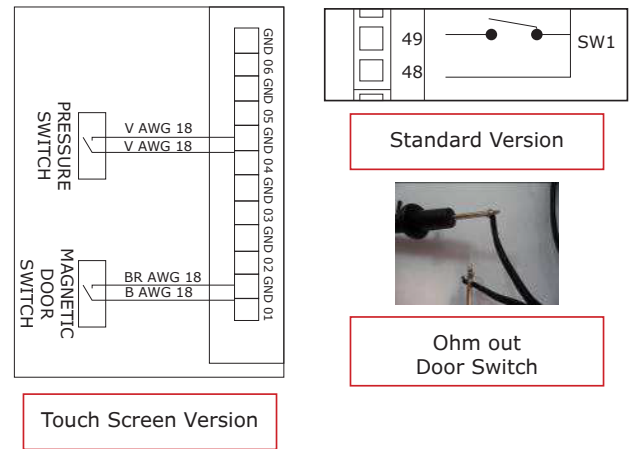

Figure 8: Door Switch Diagrams

## PRESSURE SWITCH

A pressure-regulating switch is installed to prevent compressor failures or improper operation due to high discharge pressure. Self-contained models have a high pressure switch only, while remote units have a double switch, like the one shown in Figure 9. In older models both types of applications had a double switch, triggering the alarm “hp” for either a low or high pressure event. In some recent remote applications, the pressure switch is used for pump down purposes also.

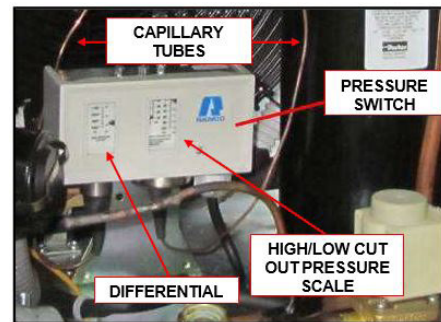

Figure 9: Pressure Switch

### Pressure Switch Working Principles – Alarm Connection

The pressure switch has normally closed contacts that open if the High or Low pressure limits are exceeded. The switch is connected to the Main Board at terminals 48 and 50 in case of standard controller (48 is a shared connection with the door switch), and terminals GND and D1 in the Touch Screen version. When the pressure switch opens from either a high or low pressure condition, the display will show the error code “hp” (or message “HIGH PRESSURE” in the Touch screen version) (see Figure 10).

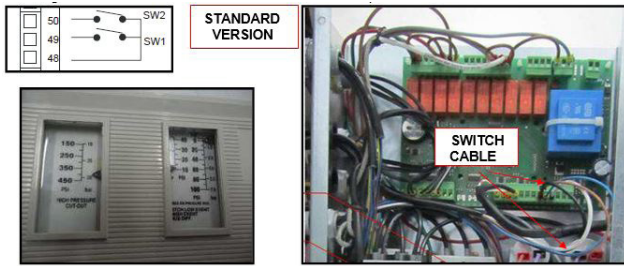

Figure 10: Alarm Connection to the Pressure Switch

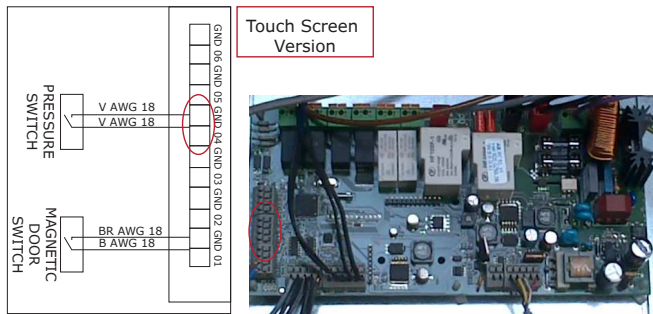

Figure 11: Pressure Switch

Current models only have a high pressure switch. After the pressures return to the normal range, the pressure switch resets automatically. Current remote applications do not have an alarm connection with the pressure switch, but will be used to pump down by low pressure, or to cut out compressor in case of high pressure (see Figure 10 and Figure 11).

### Pressure Switch Working Principles – Pump Down

Remote applications have a double pressure switch. A solenoid valve feeds refrigerant to the evaporator. This valve is closed when setpoint temperature is reached in the cabinet, allowing the compressor to pump down until pressure switch trips due to low suction pressure. The pressure switch will cut out the compressor contactor’s coil in this case, either for low pressure (pump down) or high pressure (safety).

**NOTE: No high pressure alarm message will be displayed from the controller if the remote chillers are working in pump down configuration.**

### Pressure Switch Factory Setting

The pressure switch factory settings appear in the following list:

**NOTE: Do not change these settings!**

- High pressure limit = 29 barg (425 psig)

- Low pressure limit = 0 barg (0 psig)
- Differential = 1,2 barg (18 psig)

### DOOR FRAME HEATER

Both Shock Freezer and Blast Chiller units come equipped with a door frame heater to prevent frost build-up on the door gasket. The heater may be either 115V or 220V depending on the model/rating. For 220V 3-phase units (or 220V single-phase units with no neutral), the door frame heater is connected between two live mains. The heater runs around the frame, under a plastic strip cover (see Figure 12). Electrical connections run through the lower cabinet panel to the electrical component box.

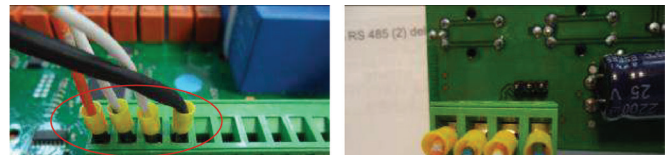

Figure 12: Door Frame Heater Components

### Heater cable features

Heater Cable Specifications

	115V	220V
Length	2.4 m	2 m (Heated)
Resistance	1.4 kΩ	2.4 kΩ
Current	80 mAmps	90 mAmps

### MAIN BOARD – STANDARD CONTROLLER

Each unit is equipped with a Main Board where the electrical components are connected. The board has 10 outputs (10 relays) as shown below. The relays control various components.

RELAY	RELATED COMPONENT
K1 (Load1)	COMPRESSOR CONTACTOR COIL
K2 (Load2)	PUMP-DOWN VALVE
K3 (Load3)	EVAPORATOR FAN MOTOR CONTACTOR COIL
K4 (Load4)	DEFROST VALVE
K5 (Load5)	UV LAMP
K6 (Load6)	HEATED NEEDLE PROBE
K7 (Load7)	CONDENSER FAN MOTOR CONTACTOR COIL
K8 (Load8)	DOOR FRAME HEATER
K9 (Load9)	LIGHT
K10 (Load10)	ALARM

# USER GUIDE

Depending on the unit's voltage rating, each load is directly connected to either L1 or Neutral. L2 is switched by the dedicated relay.

## Checking Relay Outputs

When a component is not running, determine if the related relay output is working properly. The relays should cut in and off according to the logic sequences of the controller (see Figure 13). To check an output, disconnect the input line to the relay and the output wire (e.g., to check K10, disconnect both wires on 19 and 20 terminals). Ohm out the relay terminals and check if the contact is closed when the relay is activated. Replace the board when a faulty relay stays open or becomes shorted.

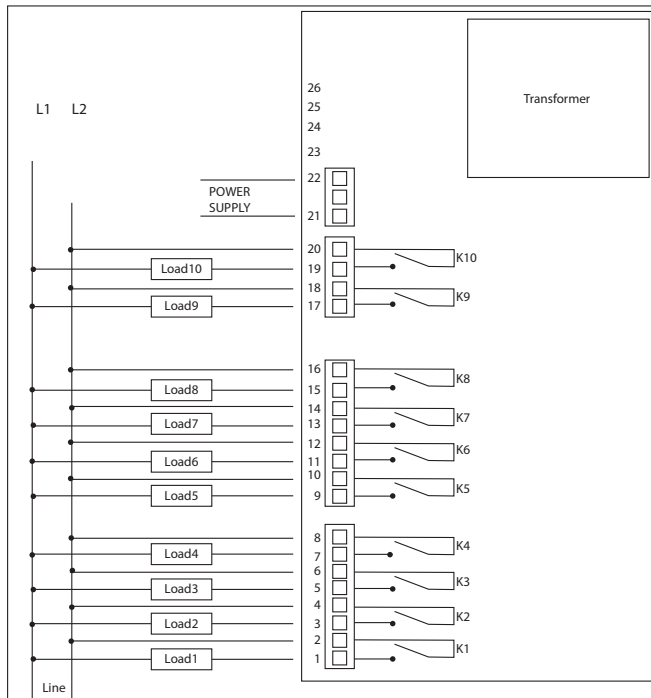
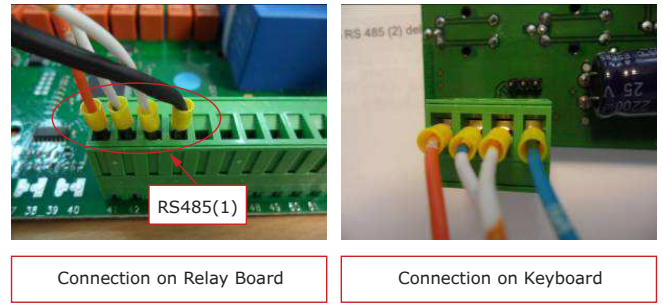

Figure 13: Relay Outputs Diagram

## KEYPAD – STANDARD CONTROLLER

The RS485(1) port on the relay board is used to connect the keyboard (see Figure 14).



Connection on Relay Board

Connection on Keyboard

Figure 14: Port Connecting Relay Board to Keyboard

## Keypad Troubleshooting

Problems with the Keypad may include:

Ground Connection Missing	Display flashes and dims
Negative (-) connection missing	Display may work without specific alarm
Positive (+) connection missing	Error Code "Err" is displayed
12V Connection missing	Display does not light.
Keypad faulty	All connections are present but display does not work.

## MAIN BOARD – TOUCH SCREEN CONTROLLER

Each unit is equipped with a Main Board where the electrical components are connected. The board has 9 outputs (8 relays plus one PWM output for evaporator variable speed). The relays control various components.

RELAY	RELATED COMPONENT
U1-N	COMPRESSOR CONTACTOR COIL
U2-N	THAWING
U3-N	DEFROST
U4-N	THAWING
U5-N	NONE
U6-N	PUMP DOWN VALVE
U7-N	DOOR FRAME HEATER
U8-N	CONDENSER FAN
PWM	EVAPORATOR FAN

## Checking Relay Outputs

The Touch Screen Controller is able to show actual state of relays through I/O menu (see Figure 15).

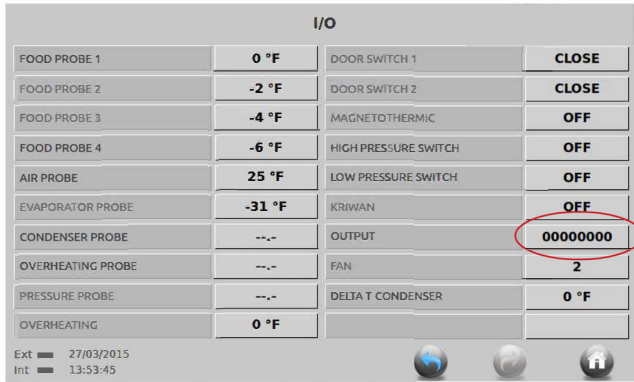

Figure 15: Output Displayed on the I/O Menu

Furthermore, the controller is able to force relay to activate and check if they are actually closing: press SERVICE/ SCANNER (see Figure 16)

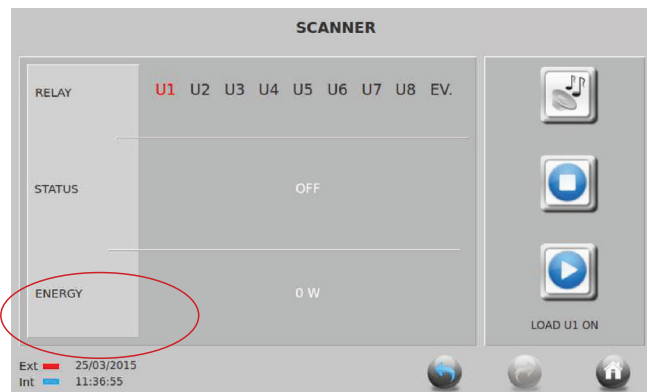

Figure 16: Scanner Selection on the Service Menu

Press the PLAY button to activate relay 1 (U1) (see Figure 17).

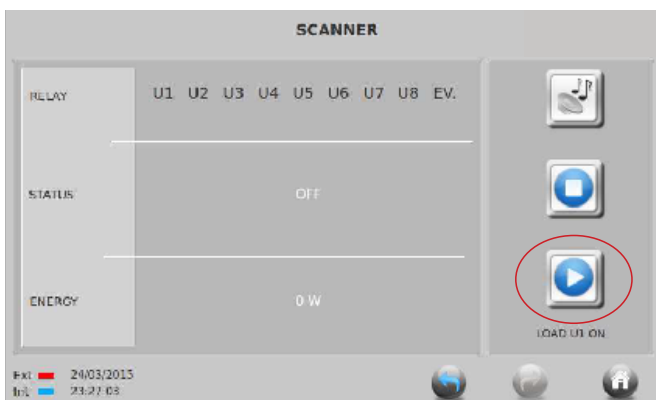

Figure 17: Press Play to Activate Relay 1

After pressing the PLAY button, "LOAD U1 ON" appears (see Figure 18).

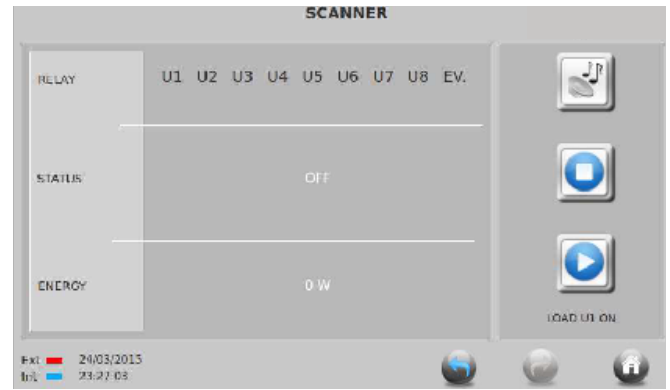

Figure 18: Relay Status Display

The relay #1 (output N-U1 on the relay board) is turned on. Wait a few seconds until the power board feeds a signal back to the display to prove that the relay is actually closed (U1 will become red and STATUS will change to ON) (see Figure 19).

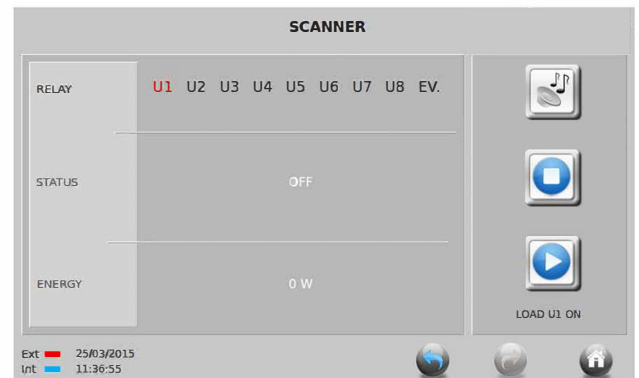

Figure 19: U1 Relay Appears Red

Meanwhile the power consumption on that relay output appears in the ENERGY row, to monitor any absorption by the component supplied by relay 1 and how much the absorption is.

**NOTE: When using an additional contactor or power relay connected on the power board, the power absorption will not show the actual power pulled by the electrical load connected with that contactor or power relay.**

Press the PLAY button again to activate relay #2, or STOP to de-activate the relay (see Figure 20). Press the music icon to test the buzzer.

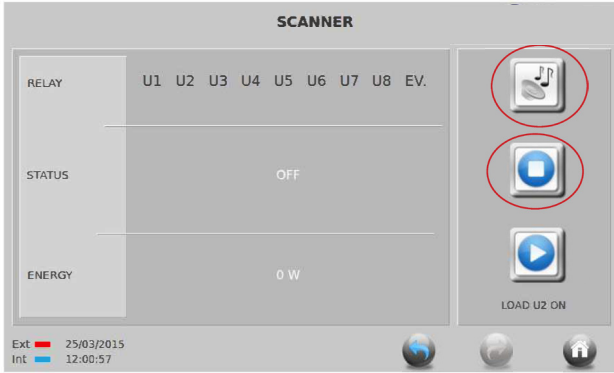

Figure 20: Activating Relay #2

## DISPLAY – TOUCH SCREEN VERSION



Figure 21: USB Port

The RS485 port on the relay board is used to connect the keyboard (see Figure 22).

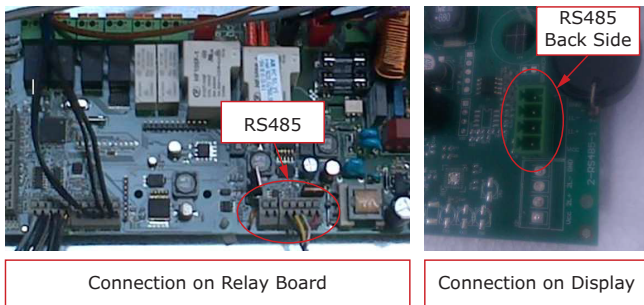

Figure 22: RS485 Port Connection

## Touch Screen Display Troubleshooting

Monitor the communication between the Display and Power Boards by looking at signals Ext/Int on the bottom left side of the Display. Both signals blink “Blue” if communication

is good. One or both will blink “Red” if an error is occurs (see Figure 23). Check the connection cable for continuity to find a cable issue, or troubleshoot the Display or Power Boards.



Figure 23: Ext/Int Indicators

## REFRIGERANT PRESSURES CHECKS

High or Low refrigerant pressure levels are dependent on:

- Ambient temperature
- Heat load in the cabinet (Full or Empty)
- Status of the cycle (hot food, frozen food, etc.)
- Cabinet temperature
- TX valve regulation
- Evaporator coil air flow
- Condenser coil air flow

Checking High and Low pressures on the unit cannot determine if the unit is operating correctly. Careful analysis, based on the conditions listed, is necessary to properly diagnose a problem.

For example: Checking the suction pressure results in a reading of 0.1 barg. This pressure could be correct if the cabinet temperature is at the minimum (-40°C) and the evaporator temperature is at -45°C.

If this is not the case, the evaporator may not be getting sufficient refrigerant and the actual evaporator temperature could be much higher than -45°C. It is not recommended to base any troubleshooting conclusions solely on the pressure readings.

### SUCTION PRESSURE: 0.1/0.2 barg

Measure this pressure when the cabinet temperature is at -40°C with the compressor running.

### DISCHARGE PRESSURE: 16 barg

This pressure can vary greatly and reach up to 25 barg psig, depending on the ambient temperature and heat load inside the cabinet. Very high discharge pressures can cause the pressure switch to signal an alarm.

# USER GUIDE

## Wire Diagram

### SCHEME OF COMPONENTS

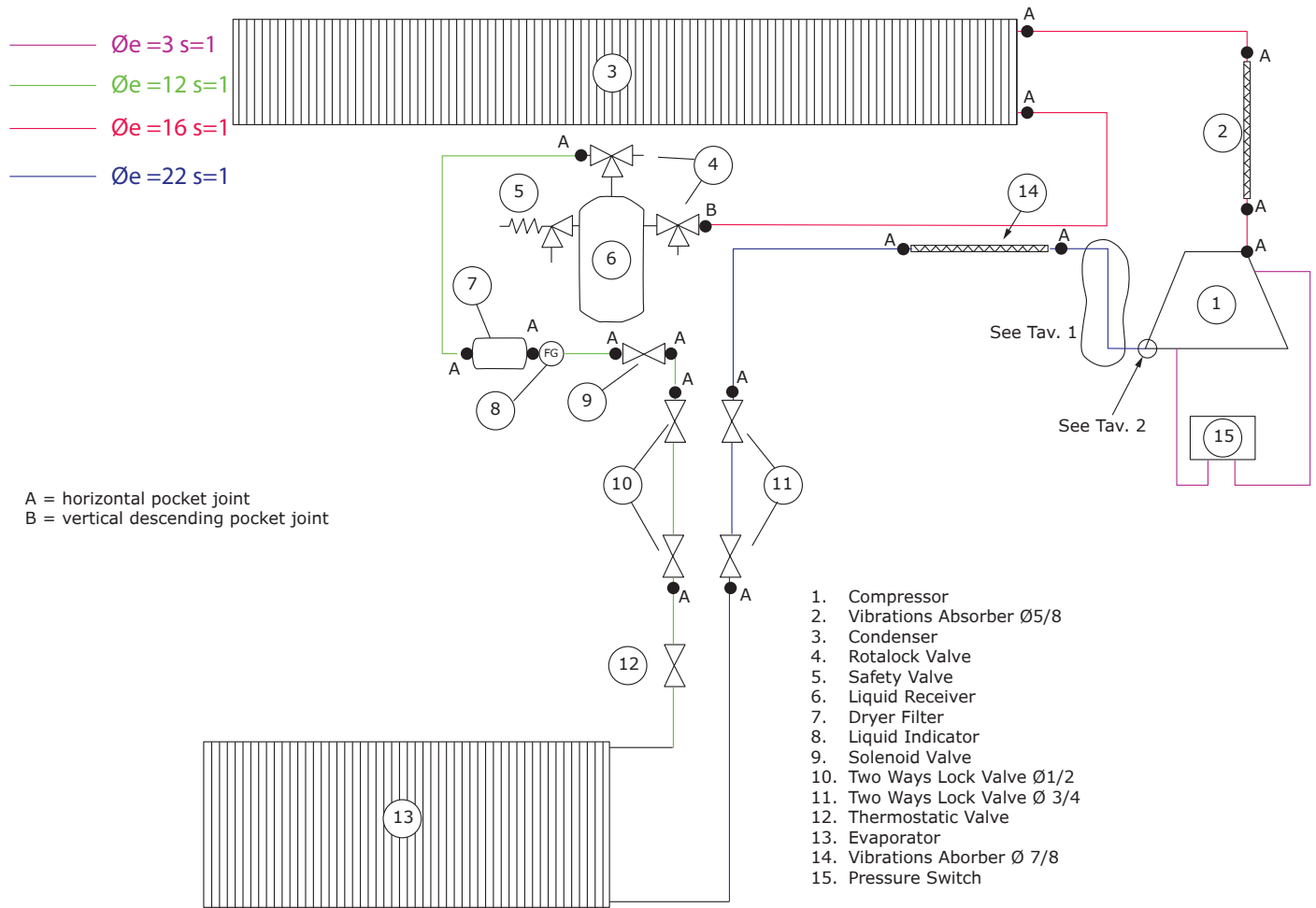

# USER GUIDE

## HOOK ELECTRICAL POWER TO THE UNIT

The Blast Chiller cabinet requires electrical power for the evaporator fans (4 or 5 for a single rack model), electronics controller, feeding valve, frame heater and similar. All the mentioned components are single phase, therefore the unit requires only two hot lines (or 1 line and neutral, depending on the mains voltage). The voltage among lines must be 208V or 220-240V, either 50 or 60 Hz. To hook the power to the cabinet just open the electrical metal box on the top of the cabinet and connect L1 and L2 on the power block.

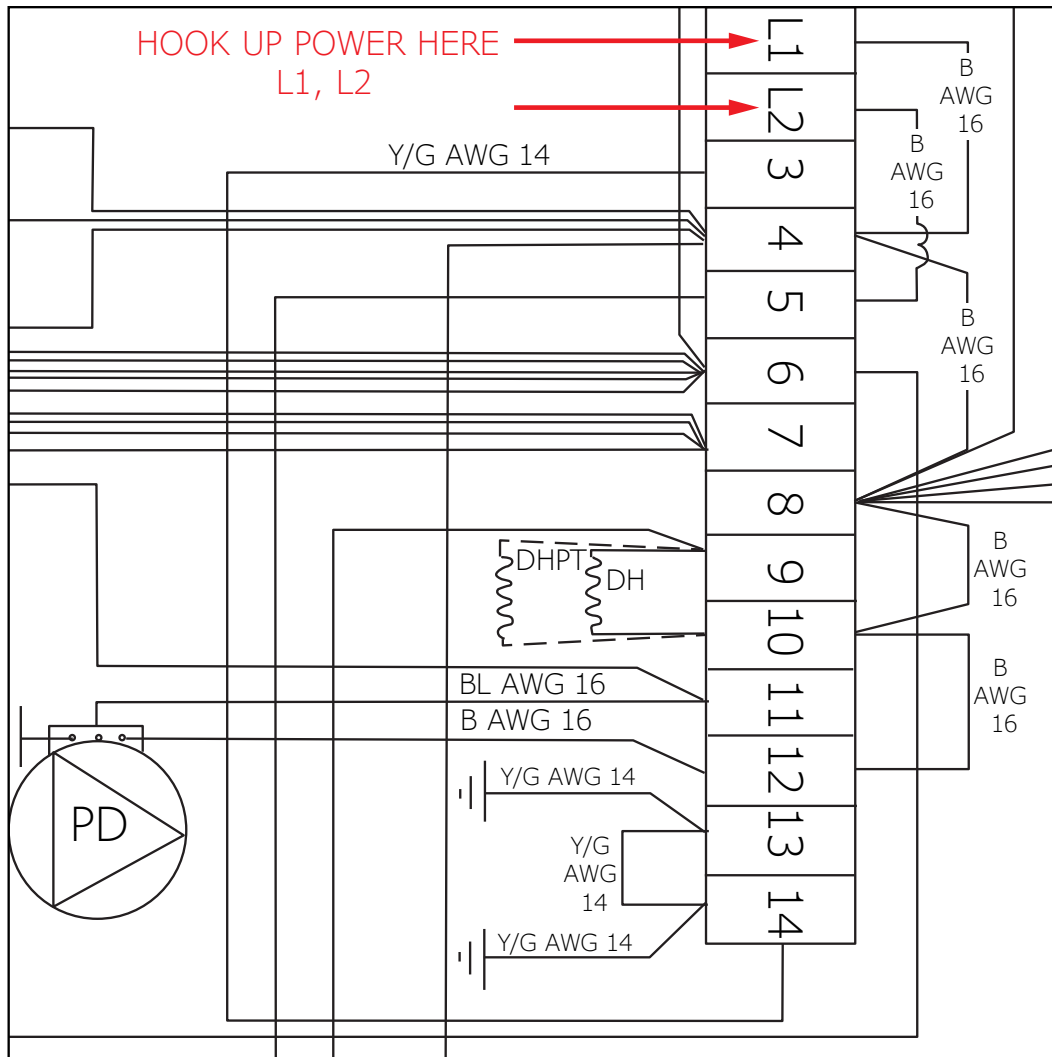



# USER GUIDE

The wiring diagram is provided in a plastic bag in the electrical box.

## Remote Blast Chiller - No Condensing Unit 220/3/60 PE

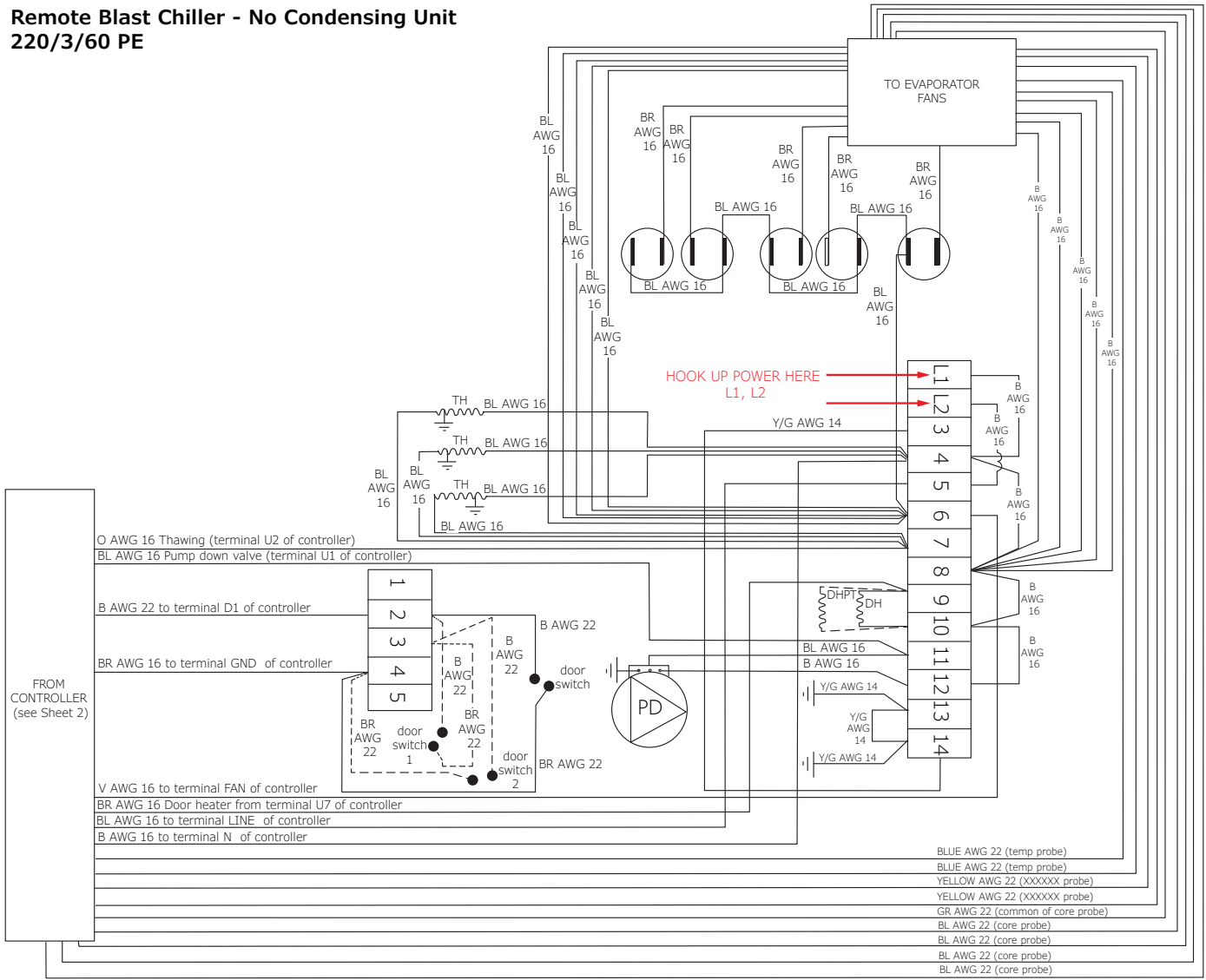

## Product Liability

Field service technicians are authorized to make an initial assessment in the event of reported damages. If there are any questions about the process involved, the technician should call U-Line for further explanation.

While inspecting for defects or installation issues, photos should be taken to document any damages or issues found.

During the assessment, if the service technician is able to find the source of the damage and it can be resolved by replacement of a part, the servicer is authorized to replace the part in question. The part that caused the damage must be returned to U-Line in its entirety. The part must be clearly labeled with the serial number of the unit it was removed from, the date, and the servicer who removed the part.

If the service technician determines the damage is the result of installation issues (water connection/drain, etc.), the consumer would be notified and the issues shall be resolved at the direction of the consumer.

If damage is evident and the service technician is unable to find the source, U-Line must be contacted at +1.414.354.0300 for further direction.

8900 N. 55th Street • Milwaukee, WI 53223

T: +1.414.354.0300 • F: +1.414.354.5696

Website: [www.u-line.com](http://www.u-line.com)

**Right product. Right place.  
Right temperature Since 1962.**

# USER GUIDE

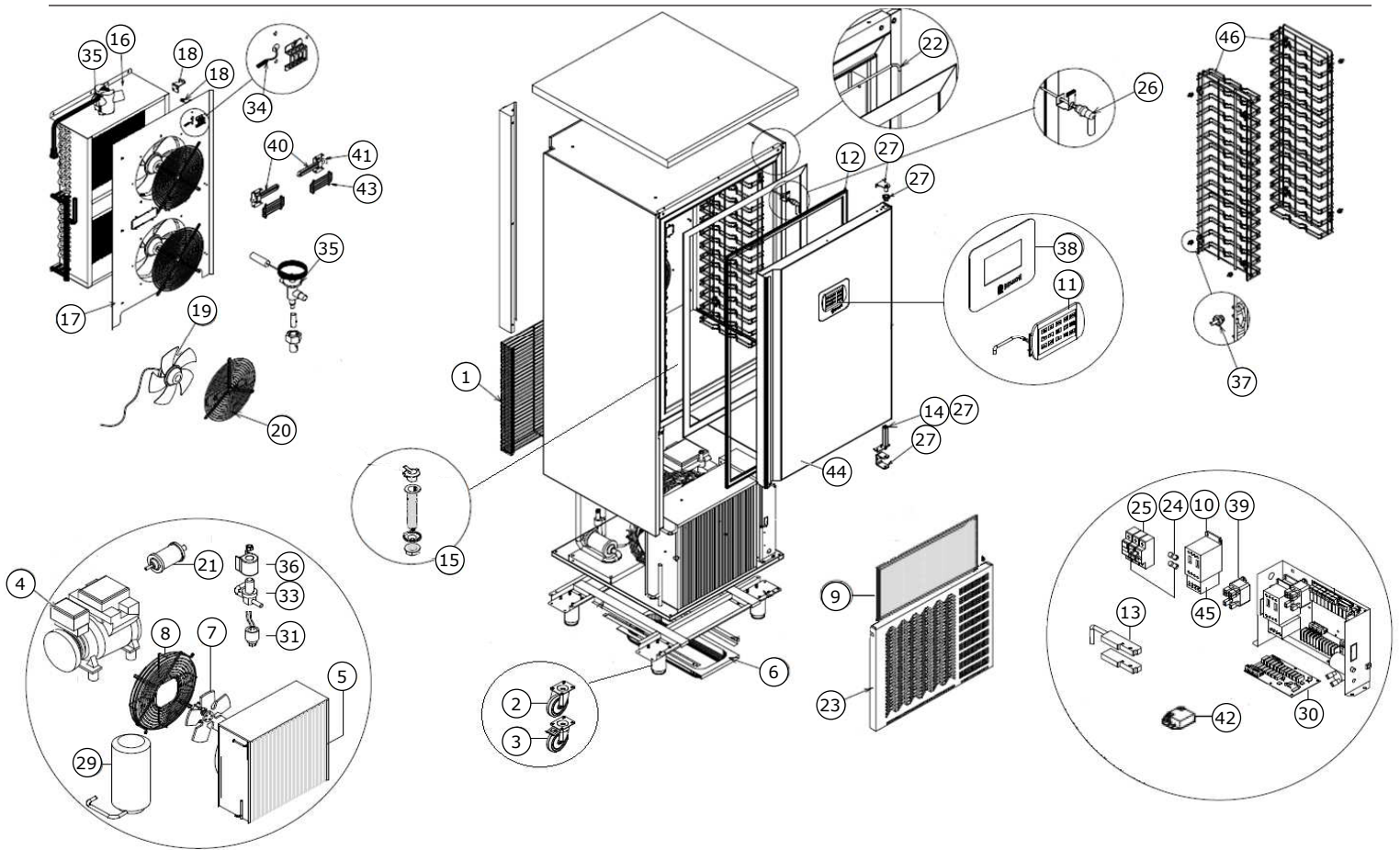

1	BACK PANEL, MOTOR COMP.	80-55654-00
2	CASTOR, FIXED	80-55649-01
3	CASTOR, SWIVEL W/BRAKE	80-55649-00
4	COMPRESSOR	80-55622-07
5	CONDENSER COIL	80-55623-06
6	CONDENSATE PAN	80-55623-07
7	CONDENSER FAN MOTOR 400MM	80-55663-35
8	CONDENSER FAN PRTCN GRID 400MM	80-55663-34
9	CONDENSER FILTER	80-55623-08
10	CONTACTOR	80-55647-00
11	DISPLAY, TOUCH SCREEN	80-55644-00
12	DOOR GASKET 730X1098MM	80-55663-32
13	DOOR MAGNETIC SWITCH	80-55651-01
14	DOOR SPRING HINGE KIT	80-55627-00
15	DRAINAGE FITTING ASSEMBLY	80-55652-00
16	EVAPORATOR COIL	80-55629-01
17	EVAPORATOR COVER&FAN HOLDER	80-55663-33
18	EVAPORATOR COVER HINGE ASSY	80-55630-08
19	EVAPORATOR FAN	80-55630-03
20	FAN FINGER GUARD, EVAP	80-55630-06
21	FILTER DRIER	80-55631-02
22	FRAME HEATER, 230V	80-55651-04
23	FRONT PANEL	80-55663-36

24	FUSE, 660V	80-55638-02
25	FUSE HOLDER	80-55638-03
26	HEATED NEEDLE PROBE	80-55632-00
27	HINGE ASSEMBLY	80-55651-05
28	KING VALVE ASSEMBLY *	80-55623-09
29	LIQUID RECEIVER	80-55623-12
30	POWER BOARD	80-55638-00
31	PRESSURE SWITCH	80-55641-01
32	PRESSURE VALVE	80-55641-03
33	SOLENOID VALVE BODY	80-55623-13
34	TEMPERATURE PROBE, NTC	80-55643-00
35	TX EXPANSION VALVE	80-55645-02
36	VALVE COIL DESMON	80-55646-02
37	SHELF RACK HOOK	80-55655-01
38	STICKER G7 TOUCH SCREEN CNTRL	80-55663-11
39	TRANSFORMER 230/12VAC 20VA	80-55663-15
40	UV LAMP MOD. G23 9W	80-55663-17
41	UV LAMP HOLDER MOD. G23	80-55663-18
42	UV LAMP BALLAST 5/7/9/11W 230V	80-55663-19
43	UV LAMP PROTECTION GRID	80-55663-31
44	DOOR PANEL W/TOUCH SCREEN	80-55663-37
45	OVERLOAD RELAY RF38	80-55663-38
46	SHELF RACK MOD. GBF-15	80-55663-39

## Ordering Replacement Parts

**Parts may be ordered online at [www.U-Line.com](http://www.U-Line.com)**

See our contact information below:

[www.U-LineService.com](http://www.U-LineService.com) (with service login)

Phone Number: +1.414.354.0300

### **NOTICE**

**Use only genuine U-Line replacement parts. The use of non-U-Line parts can reduce speed of ice production, cause water to overflow from ice maker mold, damage the unit, and void the warranty.**

Warranty parts will be shipped at no charge after U-Line confirms warranty status. Please provide the model, serial number, part number and part description. Some parts will require color or voltage information.

If U-Line requires the return of original parts, we will inform you when the parts order is taken. This requirement will be noted on your packing list. A prepaid shipping label will be emailed to you. Please enclose a copy of the parts packing list and be sure the model and serial numbers are legible on the paperwork. Tag the part with the reported defect.

Customers and non-authorized servicers may order non-warranty parts at [www.u-line.com](http://www.u-line.com). Authorized servicers with a servicer login may order non-warranty parts at [www.u-lineservice.com](http://www.u-lineservice.com).

# USER GUIDE

## R290/R600A Specifications

For R290/R600a refrigerant service tips and more videos, go to: [www.u-line.com/videos](http://www.u-line.com/videos).

### **⚠ WARNING**

**Flammability warnings for a pure-iso-butane/propane refrigerant.**



**Gloves and Eye Protection must be used.**



**R290/R600a is considered non-toxic, but is flammable when mixed with air.**

**Keep a dry powder type fire extinguisher in the work area.**



**R290/R600a is heavier than air, do not allow any leakage/migration to low areas such as basements and stairs.**

**Never use a torch on a fully charged refrigeration system.**

**Never substitute U-Line OEM replacement parts or methods of construction.**

**R290/R600a must be stored and transported in approved containers.**

## **WARNING**

**Only skilled and well trained service technicians permitted to service R290/R600a equipped products.**

**All tools and equipment must be approved for use with R290/R600a refrigerant.**

**Local, state and federal laws, standards must be observed along with proper certification and licensing.**

**Ventilation is required during servicing.**

**No conversions to R290/R600a from any other refrigerants. OEM R290/R600a equipped unit only.**

**Service area must be free of ignition sources.**

**No smoking is allowed in the service area.**

**All replacement electrical components must be OEM and installed properly (sealed and covered).**

**If the evaporator is cold prior to service, it must be thawed prior to service.**

**When using a vacuum pump, start pump before opening refrigeration system.**

**Vacuum pump and recovery equipment should be at least 10 feet from the work area.**

**It is recommended that a simple LPG gas detector is on site during service.**

**Ensure that all R290/R600a is removed from the system prior to brazing any part of the sealed system.**

**Only a clean, dry, leak-free system should be charged with R290/R600a.**

## **R290/R600a SPECIFICATIONS/LABELING**

R290/R600a equipped products are labeled (both the unit and the compressor).

R290/R600a is colorless and odorless.

R290/R600a is considered non-toxic, but is flammable when mixed with air.

Do not remove or alter any R290/R600a labeling on the product.

Use only a refrigerant grade R290/R600a from a properly labeled container.

## **RECOVERING/RECLAIMING R290/R600a**

(R290/R600a has been exempted from recovery/reclaiming requirements by the US EPA)

Recovery/Reclaiming equipment must be approved for use with R290/R600a.

Ensure the evaporator is at room temperature prior to recovery/reclaiming R290/R600a.

Use a common piercing pliers or piercing valve to remove R290/R600a from the compressor process tube. (Note: Piercing devices must not be left on the system and must be replaced with a Schrader type valve.)

# USER GUIDE

---

Evacuate/reclaim via the piecing pliers to ensure the system is empty of R290/R600a before any system work is performed.



The recovery cylinder must be evacuated (no air inside) prior to accepting R290/R600a.

The recovery cylinder must not be filled more than 45% safe fill level and refrigerants must not be mixed.

The recovery cylinder must be clearly marked with R290/R600a and Flammable Warning labels.

Ensure proper ventilation during recovery/reclaiming of R290/R600a.

Start vacuum pump/recovery pump prior to piercing the compressor process tube.

Follow recovery/reclaim OEM instructions for the specific equipment used.

## SYSTEM REPAIR

Ensure no residual R290/R600a refrigerant is left within the system prior to repair (simple venting is not sufficient).

Evacuate and charge with dry nitrogen for leak checks.

Repair leaks or replace system parts as required.

When re-brazing, the system must be purged with dry nitrogen and at least one access point open to the atmosphere.

When re-brazing, proper ventilation is required along with constant monitoring for the presence of R290/R600a refrigerant.

The filter dryer must be replaced any time the sealed system is serviced.

No system should be open to the atmosphere for longer than 15 minutes to avoid moisture migration into the system components.

## LEAK DETECTION

After removal of the R290/R600a, the unit can be charged with dry nitrogen or helium.

Electronic leak detection or soap solution can be used to check for nitrogen/helium leaks. Evacuate and charge with dry nitrogen for leak checks.



Never use a halide torch or lighted match to check the system for leaks at any time.

The high side of the refrigeration system (compressor discharge to outlet of drier) must be leak tested with the compressor running.

# USER GUIDE

---

The low side of the refrigeration system (evaporator, compressor and suction line) must be leak tested with the compressor off (equalized pressure).

## RECHARGING

No air is ever to be allowed inside the refrigeration system (R-600a refrigerant or dry nitrogen only).

Never use a torch on a fully charged refrigeration system.

Install a Schrader Type access port on the compressor process stub.



Evacuate the system to 100 microns prior to charging. Weigh in the R290/R600a charge using a refrigerant scale. (run compressor an extra two minutes to clear the charging hoses).

Seal the Schrader Type access port, a proper cap and seal must be used to close the system.

No system should be open to the atmosphere for longer than 15 minutes to avoid moisture migration into the system components.



## SUMMARY

Safely handling R290/R600a requires proper procedures and training.

R290/R600a approved service tools must be used.

R290/R600a labeling must not be removed or altered.

Proper ventilation during service is required.

Never apply a torch to a charged R290/R600a refrigeration system.

Use OEM replacement service parts and do not alter the construction of the unit.

No air is ever to be allowed inside the refrigeration system (R290/R600a refrigerant or dry nitrogen only).

Never use a torch on a fully charged refrigeration system. Install a Schrader Type access port on the compressor process stub.

The filter dryer must be replaced any time the sealed system is serviced.

No system should be open to the atmosphere for longer than 15 minutes to avoid moisture migration into the system components.

## LEAK DETECTION

After removal of the R290/R600a, the unit can be charged with dry nitrogen or helium.

Electronic leak detection or soap solution can be used to check for nitrogen/helium leaks. Evacuate and charge with dry nitrogen for leak checks.



# USER GUIDE

## BASIC SERVICE DIAGNOSTIC (TOUCH SCREEN CONTROLLER)



The Touch Screen Controller displays alarms that identify the cause of a problem and the components and circuits involved. In addition, a diagnostic service menu allows technicians to quickly check the temperature sensors (such as the needle probe, the chamber probe or the evaporator probe), the relay status, the door switch input, and many other things.

### Alarm/Failure List

ALARM MESSAGE	NOTES/CONSEQUENCES
DOOR	The door is open for too long during a cycle.
MAINTENAINCE	Perform a regular service inspection and preventive maintenance. Call service for more information.
CONDENSER HIGH TEMPERATURE	The condenser temperature is too high if compared to a normal working condition, defined by a temperature threshold. For this version of Blast Chiller, the alarm is not enabled, because the condenser probe is not installed.
HIGH PRESSURE	Head pressure is too high, exceeding 29 barg (425 psig). Check for a clogged condenser, condenser fan motor not running or pump down valve not opening when the compressor is running.
EVAPORATOR LOW TEMPERATURE	The evaporator temperature is too low when compared to the current setpoint temperature. A differential parameter LBT states the maximum gap should exist between setpoint temperature and evaporator temperature. The alarm may occur the setpoint temperature changes during a multistep automatic recipe, but the evaporator temperature remains low. Avoid this non-critical alarm by setting the LBT as high as possible (i.e., 72°F [40°C]).

ALARM MESSAGE	NOTES/CONSEQUENCES
DEFROSTING TIME	The defrost process did not stop within the maximum defrosting time. The defrost ends by coil temperature (DTE). If the stop does not happen within DTO minutes, then the alarm triggers. Check the evaporator coil icing status; if one defrost is not enough, repeat the defrost. If the alarm occurs during the holding cycle, the problem may be with the defrost device (hot gas valve). Using the Blast Chiller as a holding cabinet for too long may cause this alarm.
ELECTRICAL FEEDING	The voltage supply is not within the safety range. The parameter MRV Main Reference Voltage determines the range by plus or minus 20%. Check the voltage actual reading from the Energy section during a cycle. Call Service if low or high voltage is suspected.
LOW TEMPERATURE	Occurs during the holding cycle, if the air temperature goes below the lower temperature limit, parameter ALL. This parameter is differential to the setpoint.
HIGH TEMPERATURE	Occurs during the holding cycle, if the air temperature goes above the higher temperature limit, parameter ALH. This parameter is differential to the setpoint.
AIR PROBE (S1)	Air probe failure. Call Service.
EVAPORATOR PROBE (S2)	Evaporator probe failure. Call Service.
CONDENSER PROBE	(S3) (Not applicable in this version of Blast Chiller) Condenser probe failure. Call Service.
FOOD PROBE (PT1)	Insert probe core 1 failure. Call Service.
FOOD PROBE (PT2)	Insert probe core 2 failure. Call Service.
FOOD PROBE (PT3)	Insert probe core 3 failure. Call Service.
FOOD PROBE (PT4)	Insert probe core 4 failure. Call Service.
RELAY 1,2,...,8 BROKEN	The electronic board detected a failure on Relay 1,2,...8. Call Service.
TRIAC BROKEN	The electronic board detected a failure on the PWM output for evaporator fan variable speed. Call Service.
BLACK OUT	The system recorded a power interruption without switching off the display.

**NOTE: This version of touch screen controllers has no high/low pressure alarms. The high/pressure switch will cut out contactor coil for safety or pull down purpose.**

# USER GUIDE

**NOTE: Monitor correct communication between display and power board from signals ext/int on the left bottom side of the display. Both signals blink "blue" if communication is good. One or both blink "red" if an error occurs. Check the connection cable for continuity.**



## Failure Code Details

When an alarm occurs, an Alert icon blinks on the screen and the buzzer activates. Click on the Alarm icon to see details (see Figure 1 and Figure 2).

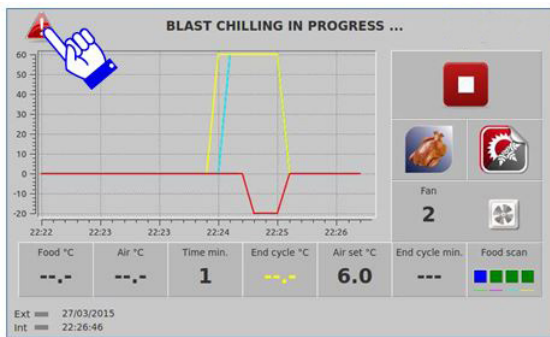

Figure 1: Alarm Icon

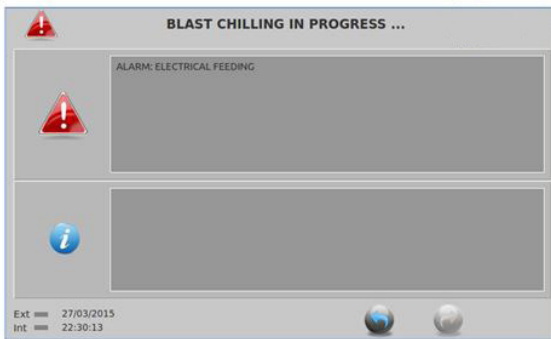

Figure 2: Alarm Message

## Service Menu – Configuration Parameters

Entering the configuration parameter

From the HOME screen, press MORE, then SERVICE (see Figure 3 and Figure 4).

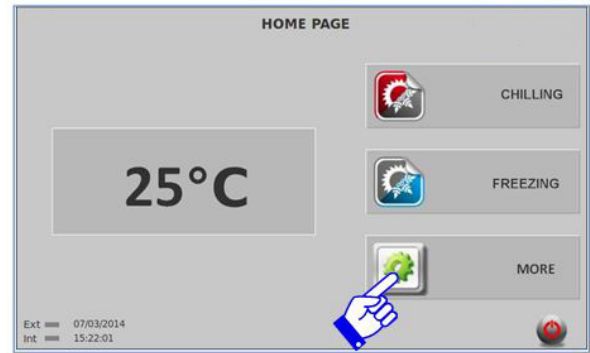

Figure 3: More Icon



Figure 4: Service Icon

Insert the 4-digit password and hit OK to enter the menu (see Figure 5).

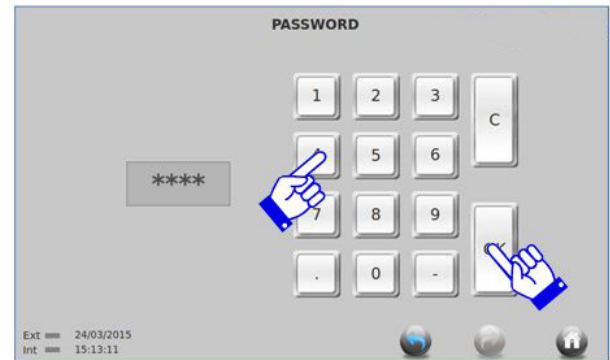

Figure 5: Password Screen

Press PARAMETERS (see Figure 6).



Figure 6: Parameters Icon

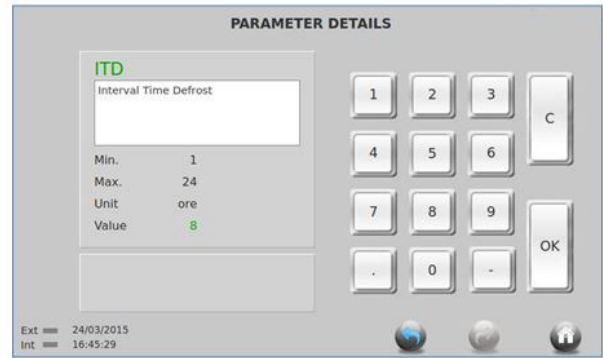

Figure 9: Parameter Details Display

Press the left or right arrow to scroll pages (see Figure 7).

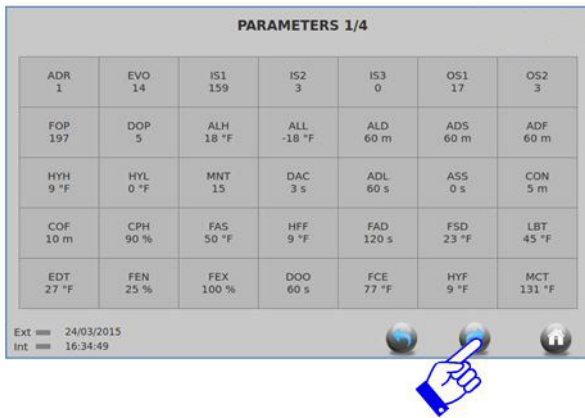

Figure 7: Left and Right Arrows

Press the specific parameter to check or change the value.

Use the keyboard to change the parameter value and press OK to confirm the change (see Figure 8 and Figure 9).

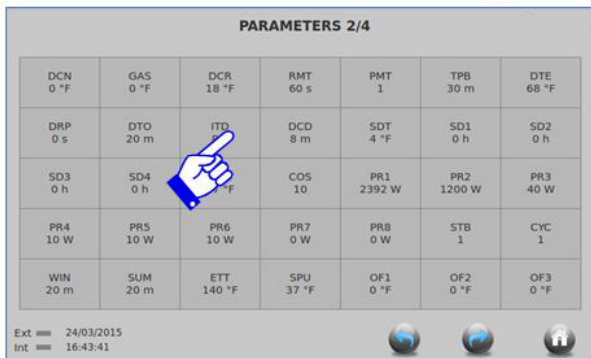

Figure 8: Parameter Values Displayed

## Parameter List (factory settings)

Parameter	Description	5 PANS 115V	5 PANS 230V	Self Contained 230v	Trolley
ADR	serial address [num]	1	1	1	1
EVO	alarm intervention super-parameter [num]	0	0	0	0
IS1	probes and door input configuration super-parameter [num]	155	155	155	155
IS2	digital input configuration super-parameter [num]	8	8	8	8
IS3	not used	0	0	0	0
OS1	additional output super-parameter [num]	0	0	0	0
OS2	additional output super-parameter [num]	0	0	0	0
FOP	fans mode super-parameter [num]	131	131	131	135
DOP	defrost mode super-parameter [num]	7	7	7	5
ALH	upper temperature alarm limit [°C/°F]	50	50	50	50
ALL	lower temperature alarm limit [°C/°F]	14	14	14	14
ALD	temperature alarm delay [min]	60	60	60	60
ADS	temperature alarm delay after start [min]	180	180	180	180
ADF	temperature alarm delay after defrost [min]	120	120	120	120
HYH	upper differential cooling action [°C/°F]	4	4	4	4

# USER GUIDE

Parameter	Description	5 PANS 115V	5 PANS 230V	Self Contained 230v	Trolley
HYL	lower differential cooling action [°C/°F]	0	0	0	0
MNT	number of trays of blast chiller [num]	15	15	15	15
DAC	compressor stop delay [sec]	3	3	3	3
ADL	minimum time of stop compressor [sec]	60	60	60	60
ASS	start compressor delay at power on [sec]	30	30	30	30
CON	compressor on time in probe faulty [min]	5	5	5	5
COF	compressor off time in probe faulty [min]	10	10	10	10
CPH	not used	90	90	90	90
FAS	evaporator fan set point [°C/°F]	50	50	50	50
HFF	differential of fan set point [°C/°F]	9	9	9	9
FAD	delay of fan start in evaporator probe faulty [sec]	5	5	5	5
FSD	stop evaporator fan temperature in defrost [°C/°F]	14	14	14	14
LBT	minumum evaporator temperature related to set point [°C/°F]	50	50	50	50
EDT	choking evaporator fan temperature range [°C/°F]	59	59	59	59
FEN	minimum evaporator fan speed % [num]	25	25	25	25
FEX	maximum evaporator fan speed % [num]	95	95	95	95
DOO	max open door time before door alarm [sec]	60	60	60	60
FCE	condenser fan set point [°C/°F]	77	77	77	77
HYF	upper differential condenser fan action [°C/°F]	9	9	9	9
MCT	max condenser temperature [°C/°F]	131	131	131	131
DCN	dirty condenser threshold [°C/°F]	0	0	0	0
GAS	low refrigerant amount alert threshold [°C/°F]	0	0	0	0

Parameter	Description	5 PANS 115V	5 PANS 230V	Self Contained 230v	Trolley
DCR	differential for restarting blast chiller after high condenser temperature [°C/°F]	18	18	18	18
RMT	stop time during high condenser temperature [sec]	180	180	180	180
PMT	max high condenser event before high temp. Alarm [num]	3	3	3	3
TPB	time threshold for high condenser temp. Alarm [min]	30	30	30	30
DTE	defrost ending temp related to evap. Probe [°C/°F]	41	41	41	41
DRP	dripping time after defrost [sec]	60	60	60	60
DTO	defrost timeout [min]	10	10	10	10
ITD	interval between two consecutive defrosts [hours]	8	8	8	8
DCD	max on-time drain heater [min]	8	8	8	8
SDT	ice detecting sensitivity in smart defrost mode [num]	0	0	0	0
SD1	first daily defrost [hour]	0	0	0	0
SD2	second daily defrost [hour]	0	0	0	0
SD3	third daily defrost [hour]	0	0	0	0
SD4	fourth daily defrost [hour]	0	0	0	0
SPX	door frame heater set point [°C/°F]	14	14	14	14
COS	average power factor of equipment [num]	5	5	5	5
PR1	declared power connected to relay1 [num]	0	0	0	0
PR2	declared power connected to relay2 [num]	0	0	0	0
PR3	declared power connected to relay3 [num]	0	0	0	0
PR4	declared power connected to relay4 [num]	0	0	0	0

# USER GUIDE

Parameter	Description	5 PANS 115V	5 PANS 230V	Self Contained 230v	Trolley
PR5	declared power connected to relay5 [num]	0	0	0	0
PR6	declared power connected to relay6 [num]	0	0	0	0
PR7	declared power connected to relay7 [num]	0	0	0	0
PR8	declared power connected to relay8 [num]	0	0	0	0
STB	number of cycles during D test [num]	5	5	5	5
CYC	number of on7off cycles during D test [num]	5	5	5	5
WIN	max pull down time in winter D test [num]	90	90	90	90
SUM	max pull down time in summer D test [num]	120	120	120	120
ETT	set point in heating cycle during D test [°C/°F]	59	59	59	59
SPU	user set point in storage cycle [°C/°F]	37	37	37	37
OF1	cabinet probe offset [num]	-0.7	-0.7	-0.7	0
OF2	evaporator probe offset [°C/°F]	0	0	0	0
OF3	condenser probe offset [°C/°F]	0	0	0	0
OF4	core probe point 1 offset [°C/°F]	0	0	0	0
OF5	core probe point 2 offset [°C/°F]	0	0	0	0
OF6	core probe point 3 offset [°C/°F]	0	0	0	0
OF7	core probe point 4 offset [°C/°F]	0	0	0	0
OF8	core probe point 5 offset [°C/°F]	0	0	0	0

Parameter	Description	5 PANS 115V	5 PANS 230V	Self Contained 230V	Trolley
SLL	not used	-40	-40	-40	-40
SLH	not used	3	3	3	3
RHU	cabinet RH% set point settable [num]	80	80	80	80
MNS	mains voltage alarm limit [%]	20	20	20	20
MAL	voltage alarm delay [hours]	10	10	10	10

Parameter	Description	5 PANS 115V	5 PANS 230V	Self Contained 230V	Trolley
MEV	max number of voltage conditions before voltage alarm [num]	5	5	5	5
MBP	time range in which is performed the mains voltage control [hours]	1	1	1	1
RL1	relay 1 action type [num]	1	1	1	1
RL2	relay 2 action type [num]	13	13	13	13
RL3	relay 3 action type [num]	17	17	17	17
RL4	relay 4 action type [num]	13	13	13	13
RL5	relay 5 action type [num]	0	0	0	0
RL6	relay 6 action type [num]	11	11	11	11
RL7	relay 7 action type [num]	10	10	10	10
RL8	relay 8 action type [num]	1	1	1	1
SRV	remaining time before maintenance [day]	800	800	800	800
PCA	cabinet set point in prechilling [°C/°F]	28	28	28	28
PCF	evaporator fan speed in prechilling [num]	10	10	10	10
PFA	cabinet set point in prefreezing [°C/°F]	-22	-22	-22	-22
PFF	evaporator fan speed in prefreezing [num]	10	10	10	10
DWA	load tolerance on relays [%]	20	20	20	20
STO	max storage time without hot gas defrost [hours]	48	48	48	48
DFS	difference between core probe and cabinet probe to detect core probe inserted [°C/°F]	18	18	18	18
STE	sterilization cycle duration [sec]	300	300	300	300
PRH	heating core probe cycle duration [sec]	60	60	60	60
VOF	mains voltage sensor offset [num]	77	77	77	77
PTE	not used	20	20	20	20

# USER GUIDE

Parameter	Description	5 PANS 115V	5 PANS 230V	Self Contained 230V	Trolley
PTI	not used	12	12	12	12
MRT	max recharging time of battery [hours]	20	20	20	20
FCD	max first recharging time of battery [hours]	12	12	12	12
BTD	max duration of battery test [sec]	3	3	3	3
TBT	consecutive battery test interval time [min]	5	5	5	5
NMT	not used	250	250	250	250
VRS	start battery charging threshold [V/10]	11,1	11,1	11,1	11,1
VRE	end battery charging threshold [V/10]	11,3	11,3	11,3	11,3
VRT	battery voltage at ending charging for max duration [V/10]	9,8	9,8	9,8	9,8
VBR	minimum battery voltage for disabling battery [V/10]	8,6	8,6	8,6	8,6
VAD	battery voltage threshold to show "no battery" message [V/10]	3,3	3,3	3,3	3,3

Parameter	Description	5 PANS 115V	5 PANS 230V	Self Contained 230V	Trolley
VPD	battery voltage threshold to detect presence of battery [V/10]	5	5	5	5
TBK	delay time before safety turn off of battery circuit [sec]	60	60	60	60
BOF	battery voltage offset [V/10]	0	0	0	0
MST	max air temperature during thawing [°C/°F]	50	50	50	50
OFH	not used	3	3	3	3
PAT	air temperature in pre- thawing cycle [°C/°F]	43	43	43	43

Parameter	Description	5 PANS 115V	5 PANS 230V	Self Contained 230V	Trolley
PFT	evaporator fan speed in pre-thawing cycle [%]	10	10	10	10
PAC	air temperature in pre-soft cooking cycle [°C/°F]	43	43	43	43
PFC	evaporator fan speed in pre-soft cooking cycle [%]	6	6	6	6
HHL	lower differential heating action [°C/°F]	5	5	5	5
HHH	upper differential heating action [°C/°F]	5	5	5	5
MRV	nominal mains voltage [V]	115	230	230	220
PRF	evaporator fan declared power [W]	100	100	100	100
CMR	evaporator speed fan index during RH% control [num]	10	10	10	10
CPR	not used	10	10	10	10
CIN	not used	0	0	0	0
SPS	not used	7	7	7	7
TBC	not used	5	5	5	5
LPT	not used	0	0	0	0
POF	not used	0	0	0	0

## Temperature Probes Display

From the HOME screen press MORE, OPTIONS, and I/O (see Figure 10 and Figure 11).



Figure 10: Options Icon



Figure 11: I/O Icon

All relevant temperature values and input/output status appear in Figure 12.

I/O			
FOOD PROBE 1	0 °F	DOOR SWITCH 1	CLOSE
FOOD PROBE 2	-2 °F	DOOR SWITCH 2	CLOSE
FOOD PROBE 3	-4 °F	MAGNETOTHERMIC	OFF
FOOD PROBE 4	-6 °F	HIGH PRESSURE SWITCH	OFF
AIR PROBE	25 °F	LOW PRESSURE SWITCH	OFF
EVAPORATOR PROBE	-31 °F	KRIWAN	OFF
CONDENSER PROBE	--	OUTPUT	00000000
OVERHEATING PROBE	--	FAN	2
PRESSURE PROBE	--	DELTA T CONDENSER	0 °F
OVERHEATING	0 °F		

Ext = 27/03/2015  
Int = 13:53:45

Figure 12: Input/Output Information

## TROUBLESHOOTING PARAMETERS

### Parameters Restore

Restore the original parameter list that was loaded into the controller, at any time, via USB key. Press PARAMETERS RESTORE (see Figure 13).



Figure 13: Service Menu

Press the green checkmark to confirm (see Figure 14).

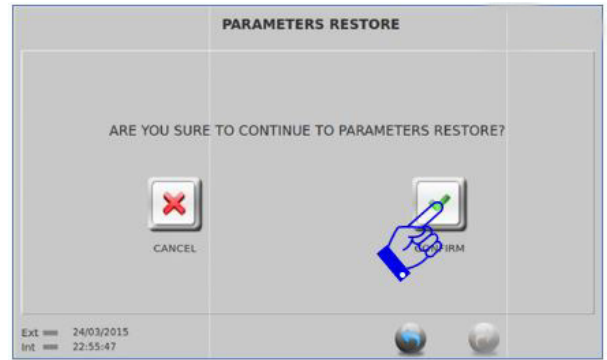

Figure 14: Green Checkmark Confirmation

Wait until the screen returns to the main service options (see Figure 15).



Figure 15: Waiting Display

### 6.4. Door Openings

Use this function to check door opening events, date, opening duration, and critical events in which air temperature exceeded the threshold value (see Figure 16).

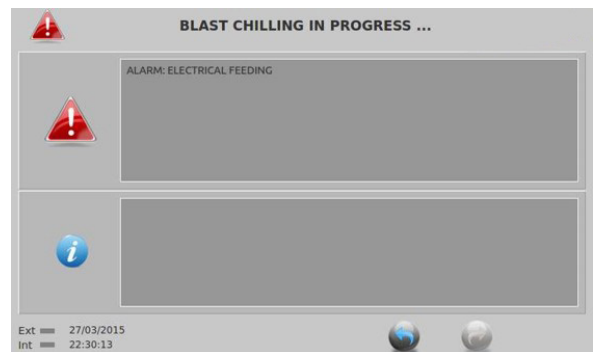

Figure 16: Advanced Service Functions

This is one of the most advanced service functions, which allows to force each board relay to activate and deactivate (see Figure 16).

Press the PLAY button to activate relay 1 (U1) (see Figure 17).

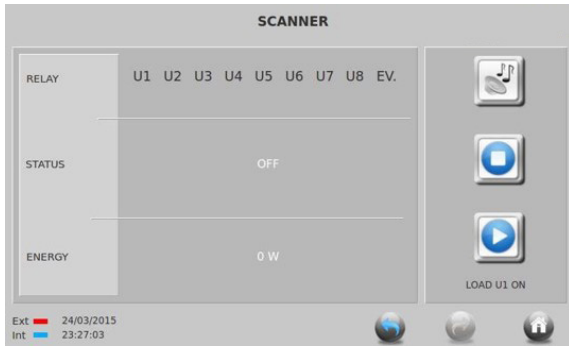

Figure 17: Relay Display

After pressing the PLAY button, below “LOAD U1 ON” will appear.

The relay #1 (output N-U1 on the relay board) gets turned on. After a few seconds, the power board feeds a signal back to the display to prove that the relay is actually closed (U1 becomes red and the STATUS will change to ON) (see Figure 18).

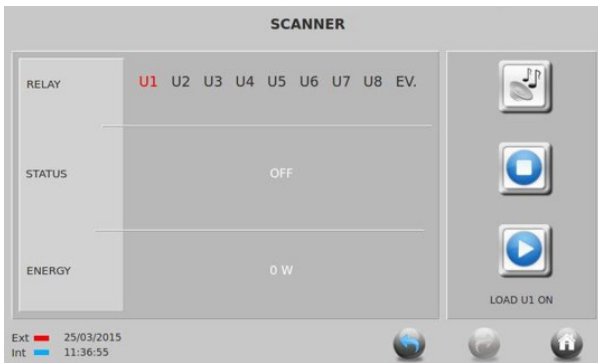

Figure 18: Relay Displayed in Red

Meanwhile the power consumption on that relay output will appear in the row ENERGY, to monitor if there is any absorption by the component supplied by relay 1 and how much the absorption is.

**NOTE: When using an additional contactor or power relay connected on the power board, the power absorption will not show the actual power pulled by the electrical load connected with that contact or power relay.**

Press PLAY button to activate relay #2, or STOP to de-activate the relay (see Figure 17). Press the music icon to test the buzzer.

## Serial Number

Enter the serial number of the Equipment to associate the electronic board to that Equipment (see Figure 19). Press OK to confirm.



Figure 19: Serial Number and Keyboard

## Optional (also written “Option” in some software release)



Figure 20: Optional Menu

This menu enables or disables advanced functions, such as: Core probe heating function, Sterilizer, Heating functions (left side) or Blast freezing cycle, temperature display mode, Celsius [°C] or Fahrenheit [°F] (see Figure 20 and Figure 21).

**NOTE: Disabling the Blast Freezing cycle will only permit to select a Soft Chilling Cycle from the Main selection screen.**



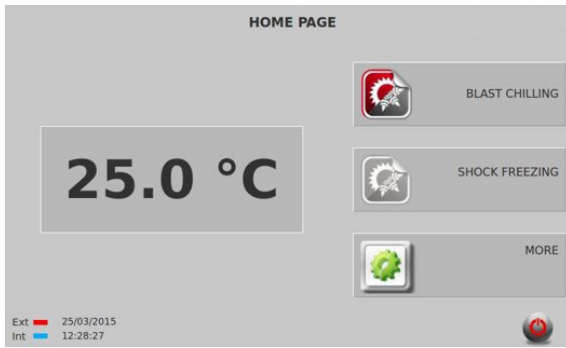

Figure 21: Home Page Display

## Maintenance

Reset either the lifetime counter of the machine or the alarm list. Press the related tab and confirm the reset (see Figure 22).

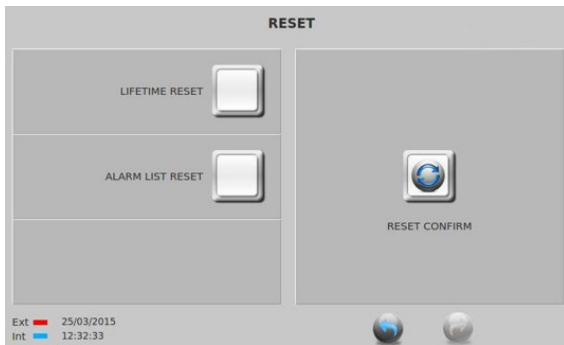

Figure 22: Reset Menu

## Cal (Display Calibration)

The display calibration allows to optimize the touch screen performance, ensuring precise reaction.

Press the CAL tab, locate the red cross in the upper left hand corner and press it, the cross will move to the upper right hand corner, press there and then to the lower left hand corner, press there and finally to the lower right hand corner, press there. Press the green checkmark, and the calibration is completed.



Figure 23: Green Checkmark Confirmation

## Test Cal (Display Calibration Test)

This function allows testing of the current display calibration, verifying that the touch commands are accurately recognized from the display.

Press the 4 targets and verify that target identification in the center of the screen is consistent (see Figure 24).

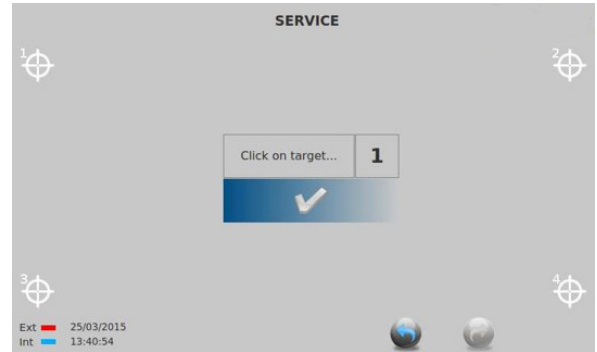

Figure 24: Testing Calibration

## Compressor Specifications



**Electrocution can cause death or serious injury. Burns from hot or cold surfaces can cause serious injury. Take precautions when servicing this unit.**

**Disconnect the power source.**

**Do not stand in standing water when working around electrical appliances.**

**Make sure the surfaces you touch are not hot or frozen.**

**Do not touch a bare circuit board unless you are wearing an anti-static wrist strap that is grounded to an electrical ground or grounded water pipe.**

**Handle circuit boards carefully and avoid touching components.**

	<b>EMX3115Y-115V</b>
REFRIGERANT	R600a
VOLTAGE	100V - 127 VAC
FREQUENCY	50Hz
RUN CAPACITOR	17.5 $\mu$ F/180 VAC
START WINDING	4.20 +/- 8% Q at 25 °C (77°F)
RUN WINDING	2.76 +/- 8% Q at 25 °C (77°F)
LRA	16.70A
FLA	-
STARTING DEVICE	PTC V115
OVERLOAD	T0819/07

\*All resistance readings are  $\pm$  10%

# U-Line Corporation (U-Line) Limited Warranty

## One Year Limited Warranty

For one year from the date of original purchase, this warranty covers all parts and labor to repair or replace any part of the product that proves to be defective in materials or workmanship. For products installed and used for normal residential use, material cosmetic defects are included in this warranty, with coverage limited to 60 days from the date of original purchase. All service provided by U-Line under the above warranty must be performed by a U-Line factory authorized servicer, unless otherwise specified by U-Line. Service provided during normal business hours.

## Two Year Limited Warranty (5 Class Product)

For two years from the date of original purchase, this warranty covers all parts and labor to repair or replace any part of the product that proves to be defective in materials or workmanship. For products installed and used for normal residential use, material cosmetic defects are included in this warranty, with coverage limited to 60 days from the date of original purchase. All service provided by U-Line under the above warranty must be performed by a U-Line factory authorized servicer, unless otherwise specified by U-Line. Service provided during normal business hours.

## Available Second & Third Year Limited Warranty

In addition to the standard one and two year warranties outlined above, U-Line offers a one year extension of the warranties from the date of purchase, free of charge. To take advantage of this extension, you must register your product with U-Line within 60 days from the date of purchase at [u-line.com](http://u-line.com) and provide proof of purchase. Nugget Ice Machine proof of purchase must include the purchase of an in-line water filter and filter head to qualify for this additional limited warranty.

## Five Year Sealed System Limited Warranty

For five years from the date of original purchase, U-Line will repair or replace the following parts, labor not included, that prove to be defective in materials or workmanship: compressor, condenser, evaporator, drier, and all connecting tubing. All service provided by U-Line under the above warranty must be performed by a U-Line factory authorized servicer, unless otherwise specified by U-Line. Service provided during normal business hours.

## Terms

These warranties apply only to products installed in any one of the fifty states of the United States, the District of Columbia, or the ten provinces of Canada. The warranties do not cover any parts or labor to correct any defect caused by negligence, accident or improper use, maintenance, installation, service, repair, acts of God, fire, flood or other natural disasters. The product must be installed, operated, and maintained in accordance with your product's User Guide.

The remedies described above for each warranty are the only ones that U-Line will provide, either under these warranties or under any warranty arising by operation of law. U-Line will not be responsible for any consequential or incidental damages arising from the breach of these warranties or any other warranty, whether express, implied, or statutory. Some states do not allow the exclusion or limitation of incidental or consequential damages, so the above limitation or exclusion may not apply to you. These warranties give you specific legal rights, and you may also have other rights which vary from state to state.

Any warranty that may be implied in connection with your purchase or use of the product, including any warranty of *merchantability* or any warranty *fit for a particular purpose* is limited to the duration of these warranties, and only extends to five years in duration for the parts described in the section related to the five year limited warranty above. Some states do not allow limitations on how long an implied warranty lasts, so the above limitations may not apply to you.

- The warranties only apply to the original purchaser and are non-transferable.
- The second, third, and five year warranties cover products installed and used for normal residential or designated marine use only.
- The warranties apply to units operated outside only if designed for outdoor use by model and serial number.
- U-Line Commercial products are covered by the one year and 5 year limited warranties and are not eligible for the second and third year limited warranties.
- Replacement water filters, light bulbs, and other consumable parts are not covered by these warranties.
- The start of U-Line's obligation is limited to four years after the shipment date from U-Line.
- In-home instruction on how to use your product is not covered by these warranties.
- Food, beverage, and medicine loss are not covered by these warranties.
- If the product is located in an area where U-Line factory authorized service is not available, you may be responsible for a trip charge or you may be required to bring the product to a U-Line factory authorized service location at your own cost and expense.
- Units purchased after use as floor displays, and/or certified reconditioned units, are covered by the limited one year warranty only and no coverage is provided for cosmetic defects.
- Signal issues related to Wi-Fi connectivity are not covered by these warranties.

For parts and service assistance, or to find U-Line factory authorized service near you, contact U-Line:  
8900 N. 55<sup>th</sup> Street, Milwaukee, WI 53223 • [u-line.com](http://u-line.com) • [onlineservice@u-line.com](mailto:onlineservice@u-line.com) • +1.414.354.0300