

Drop-in Self-Leveling Dispensers

Adjust-a-Fit® - Open, Shielded and Heated, ADA Height

Models

90225, 91225, 92225, 93225, 194225
90325, 91325, 92325, 93325, 193225
91425, 92425, 93425, 194425



Model 92225
Open



Model 92325
Shielded



Model 92425
Heated

Adjustable Diameter And Dispensing Height Adjustments Without Tools

Features

- Overall height to ring of 25"
- Five tube sizes, each with a 3¼" diameter adjustment range.
- Thermostatic control with minimum 100°F (38°C) - maximum 175°F (79°C).
- All models have a 22" plate stacking capacity.

Benefits

- Overall height allows for fit into ADA height-compliant counters
- Field-adjustability for spring tension and plate diameter allows for use with multiple size plates



Specifications

Unit shall be of welded stainless steel construction. Dispensers shall hang from surface opening by an 18-gauge flange ring and feature three each 22-gauge vertical side supports welded to 20-gauge bottom plate. Overall height from flange ring to base of 25" to allow for fit into ADA height-compliant counters. Self-leveling dish carriage shall be of welded stainless steel construction and shall travel vertically in dispenser tube with 3 sets of nylon roller guides for smooth operation. Carriage shall have 22-gauge removable dish platform. Unit shall feature flange mounted perimeter extension springs, which are detachable from the dish carriage to provide adjustment without tools for different weight dishes. Unit shall also feature three stainless steel dish guides running the entire height of the dispenser. Dish guides shall pivot to provide diameter adjustability of 3-1/4" (83 mm) without tools or removing components to accommodate various diameter dishes. Unit shall have a vertical plate stacking capacity of 22" (559 mm). Unit shall be NSF and UL listed.

Specifications continued on back.

Lakeside Manufacturing, Inc.

4900 West Electric Avenue • West Milwaukee, WI 53219 U.S.A.

800-558-8565 • 414-902-6400 • Fax 414-902-6446 • info@eLakeside.com • www.eLakesideFoodservice.com

Drop-in Self-Leveling Dispensers

Adjust-a-Fit® - Open, Shielded and Heated

Models

90225, 91225, 92225, 93225, 194225
 90325, 91325, 92325, 93325, 193225
 91425, 92425, 93425, 194425

Specifications Continued

Heated Models Only: Unit shall be 120 VAC 60 Hz and shall have 5' (1524 mm) power supply cable with L15-5P NEMA twist lock plug for 120 VAC. Dispenser tubes shall be fully enclosed in 22 gauge stainless steel, and have a circular bottom mounted 300 or 450 watt heater element to provide convection heat. Heating system shall feature thermostatic control in a tamper protective location with safe high-end shut off. Control shall have infinite settings between low and high temperature cut-outs. Thermostat shall be field adjustable for average interior air temperature between 100° F (38° C) and 175° F (79° C) at middle adjustable thermostatic setting. On-off switch and power indicator light shall be mounted on top flange of dispenser. Average dish temperature rise of 40° F (22° C) above ambient shall be achieved within one hour of initial heating cycle at middle adjustable thermostatic setting. Unit shall be UL listed.

OPTIONAL ACCESSORIES

- Stainless steel dispenser covers
- 208/240 VAC 60Hz (heated models)
- 220 VAC 50 Hz (heated models)

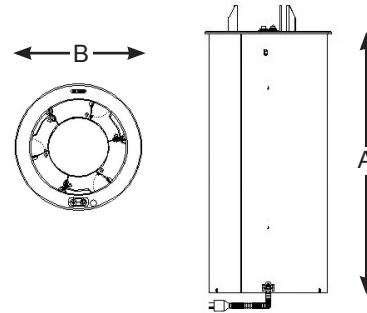

AutoCAD drawings available through KCL CADalog

Model Information

Model	Accommodates Plate Size		Height To Ring (A)		Top Ring Diameter (B)		Counter Cut-Out		Electrical		lbs.	(kg.)
									Watts	Amps		
Open Models												
90225	2-3/4" to 6"	(970 to 152)	24 3/4"	(635)	10"	(254)	9-1/8"	(232)	-	-	13	(5.9)
91225	4-1/4" to 7-1/2"	(108 to 191)	24 3/4"	(635)	11-1/2"	(292)	10-5/8"	(270)	-	-	15	(6.8)
92225	6-1/2" to 9-3/4"	(165 to 248)	24 3/4"	(635)	13-3/4"	(349)	12-7/8"	(327)	-	-	18	(8.2)
93225	8-3/4" to 12"	(222 to 305)	24 3/4"	(635)	16"	(406)	15-1/8"	(384)	-	-	20	(9.1)
194225	10" to 13-1/4"	(254 to 337)	24 3/4"	(635)	17-1/16"	(432)	16-1/4"	(413)	-	-	21	(9.6)
Shielded Models												
90325	2-3/4" to 6"	(970 to 152)	25"	(635)	10"	(254)	9-1/8"	(232)	-	-	20	(9.1)
91325	4-1/4" to 7-1/2"	(108 to 191)	25"	(635)	11-1/2"	(292)	10-5/8"	(270)	-	-	22	(10)
92325	6-1/2" to 9-3/4"	(165 to 248)	25"	(635)	13-3/4"	(349)	12-7/8"	(327)	-	-	27	(12.2)
93325	8-3/4" to 12"	(222 to 305)	25"	(635)	16"	(406)	15-1/8"	(384)	-	-	31	(14.1)
194325	10" to 13-1/4"	(254 to 337)	25"	(635)	17-1/16"	(432)	16-1/4"	(413)	-	-	32	(14.5)
Heated Models												
91425	4-1/4" to 7-1/2"	(108 to 191)	25"	(635)	11-1/2"	(292)	10-5/8"	(270)	300	2.5	25	(11.3)
92425	6-1/2" to 9-3/4"	(165 to 248)	25"	(635)	13-3/4"	(349)	12-7/8"	(327)	450	3.8	30	(13.6)
93425	8-3/4" to 12"	(222 to 305)	25"	(635)	16"	(406)	15-1/8"	(384)	450	3.8	34	(15.4)
194425	10" to 13-1/4"	(254 to 337)	25"	(635)	17-1/16"	(432)	16-1/4"	(413)	450	3.8	35	(15.9)

Measurements in () denote metric millimeters, unless otherwise specified.



Lakeside Manufacturing, Inc.
 4900 West Electric Avenue • West Milwaukee, WI 53219 U.S.A.
 800-558-8565 • 414-902-6400 • Fax 414-902-6446
 info@eLakeside.com • www.eLakesideFooservice.com