



ADA Compliant

This Space for Architect/Engineer Approval

Job Name _____ Date _____

Model Specified _____ Quantity _____

Customer/Wholesaler _____

Contractor _____

Architect/Engineer _____



Volume Control Adjustable w/ Screwdriver

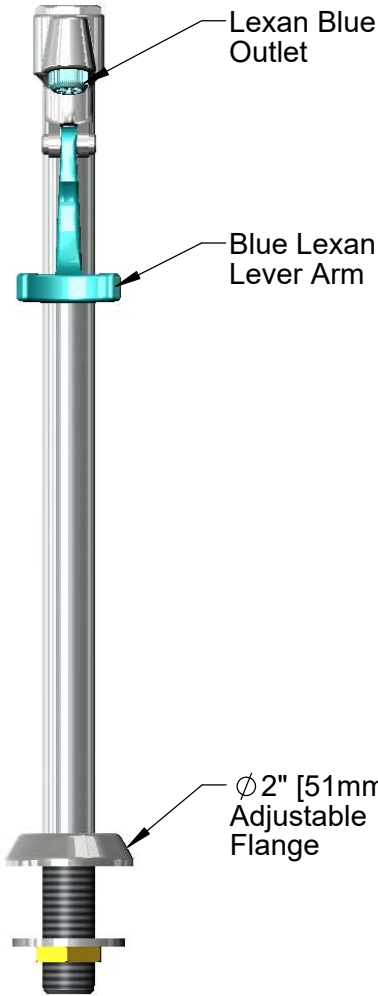

Lexan Blue Outlet

Blue Lexan Lever Arm

Ø 2" [51mm] Adjustable Flange

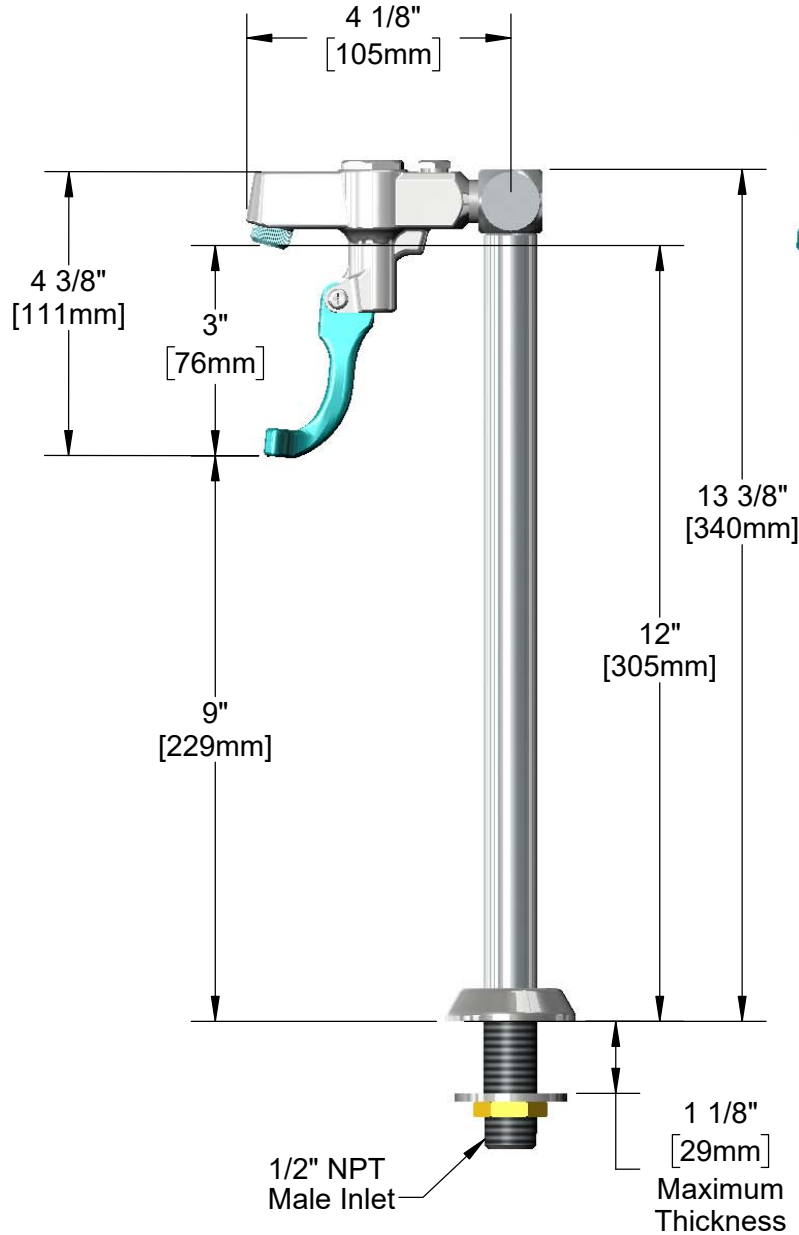

Rough-In Requirement:
Ø 1" [25mm] Hole

Model Number

5GF-12P

Product Specifications:

Pedestal Type Glass Filler, Push Back Design, 1/2" NPT Male Shank, Adjustable Flange, Blue Self-Closing Lexan Arm

Product Compliance:

ASME A112.18.1 / CSA B125.1
NSF 61 - Section 9
NSF 372 (Low Lead Content)
ANSI A117.1 (ADA)

equip
Foodservice
Accessories

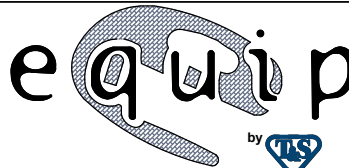

2 Saddleback Cove, P.O. Box 1088
Travelers Rest, South Carolina 29690
Phone: 800.891.4808 Fax: 800.868.0084
equip.tsbrass.com

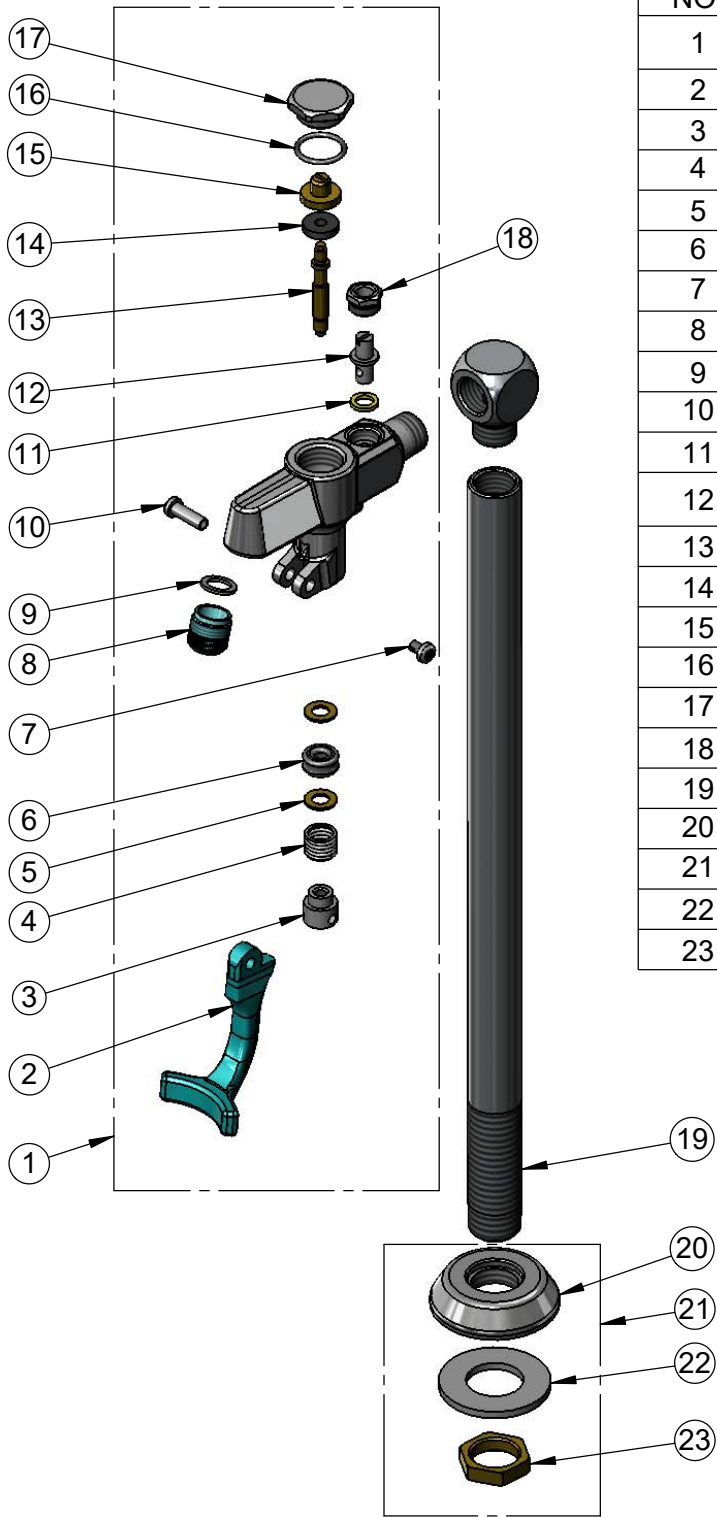

ITEM NO.	SALES NO.	DESCRIPTION
1	5GF-W	Wall Mount, 3/8" Male NPT Retro Glass Filler
2	001145-45	Lever Arm, Retro Glass Filler
3	000752-25	Push Button, Retro Glass Filler
4	000895-25	Spring
5	000974-45	Bonnet Washer
6	001100-45	Packing Seal
7	003199-45	Spray Valve Handle Screw
8	003090-45	Outlet Tip, Retro Glass Filler
9	001030-45	Washer, Retro Glass Filler Outlet
10	003198-45	Spray Valve Handle Nut
11	001031-45	Washer, Volume Control
12	000826-20	Stem, Retro Glass Filler Volume Control
13	000664-20	Stem
14	001094-45	Seat Washer
15	000664-20	Seat Washer Holder
16	001062-45	O-Ring
17	000623-40	Hex Cap
18	000714-25	Nut, Retro Glass Filler Volume Control
19	000430-40	Pedestal
20	000024-40	Deck Flange
21	016783-40	Adjustable Deck Flange
22	001033-45	Pedestal Washer
23	002954-45	Shank Lock Nut

Model Number

5GF-12P

Product Specifications:

Pedestal Type Glass Filler, Push Back Design, 1/2" NPT Male Shank, Adjustable Flange, Blue Self-Closing Lexan Arm

Product Compliance:

ASME A112.18.1 / CSA B125.1
 NSF 61 - Section 9
 NSF 372 (Low Lead Content)
 ANSI A117.1 (ADA)

equip
 Foodservice
 Accessories

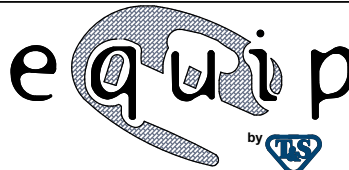

2 Saddleback Cove, P.O. Box 1088
 Travelers Rest, South Carolina 29690
 Phone: 800.891.4808 Fax: 800.868.0084
 equip.tsbrass.com