

Project _____

Item Number _____

Quantity _____

ABDR18



Automatic Bun Divider/Rounder

Model:

➤ ABDR18 4.23oz. to 9.87oz. (120g to 280g)

Features:

- Automatically divides and rounds
- Produces 18 equal weighted and shaped pieces at once
- Can produce 3200 pieces an hour
- Strong hydraulic powered machine
- Simple to use leveling feet
- Simple controls: dual start buttons for safety
- Multiple languages
- Programmable control board

Production estimate is based off a 20 second start-to-finish process with prep time included

Bun Divider/Rounder

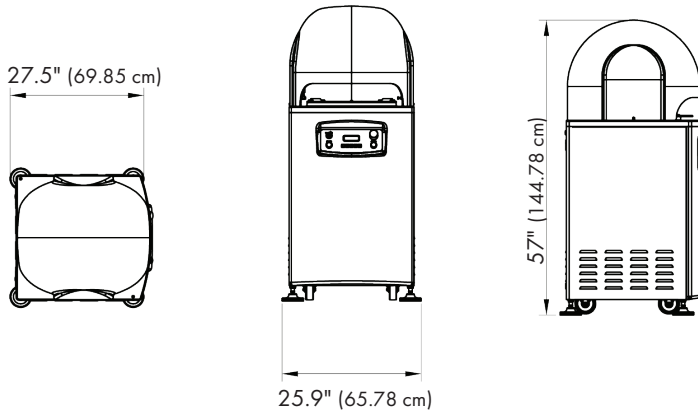

Standard Accessories:

- Three clear 18 division trays

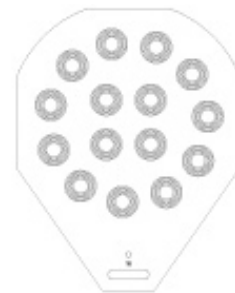

Univex Corporation

NEMA #: L-15-20-P

Electrical Information (60Hz)				
	Voltage	Phase	hp(kW)	Amps
Standard Voltage	208-240	3	1.7 (1.3)	6.87
Optional Voltage	110	1	1.6 (1.2)	20

Warranty:

- One year, on-site parts and labor

Shipping Information

Net Weight	Shipping Weight	Overall Dimensions
451.9 lbs. (205Kg)	563 lbs. (255.4Kg)	65" (165.1cm) H x 29.5" (74.9cm) W x 29.5" (74.9cm) D