

300-HW Series

Waterless Hot Food Well

UL Listed



Unlike traditional steam tables or dry wells, waterless hot food wells from Alto-Shaam feature radiant Halo Heat® technology that evenly surrounds food without the use of extremely hot elements, added humidity or fans. Extend hold times, maintain food quality and reduce operating costs to maximize return on investment.



300-HW

Standard Features

- Extend food holding times with efficient, precise Halo Heat® technology
- Maintain food quality without the use of extremely hot elements, added humidity or fans
- Increase sales with attractive food presentation and quality
- Reduce installation and operating costs with no water or plumbing needed
- Save on maintenance costs, eliminating lime and scale buildup associated with traditional steam tables
- Increase employee and customer safety with elimination of hot water and steam
- Provide optimal holding temperatures with an adjustable thermostat that can be flush-mounted into the counter or a location out of sight from customers
- Set ideal holding temperatures for any dish with an individual well control option
- HWLF models feature a large flange
- HWI and HWILF models are controlled by three (3) separate adjustable thermostats
- 300-HW/D4, 300-HW/D6, 300-HWLF/D4, and 300-HWLF/D6 models include six (6) half/third-size divider bars and two (2) large pan divider bars
- 300-HW/D443 and 300-HW/D643 models include nine (9) half/third-size divider bars and two (2) large pan divider bars
- 300-HWI/D4, 300-HWI/D6, 300-HWILF/D4, and 300-HWILF/D6 models include six (6) half/third-size divider bars
- 300-HWI/D443 and 300-HWI/D643 models include nine (9) half/third-size divider bars

Configurations (select one)

- | | |
|---------------------------------------|---------------------------------------|
| <input type="checkbox"/> 300-HW/D4 | <input type="checkbox"/> 300-HW/D6 |
| <input type="checkbox"/> 300-HW/D443 | <input type="checkbox"/> 300-HW/D643 |
| <input type="checkbox"/> 300-HWLF/D4 | <input type="checkbox"/> 300-HWLF/D6 |
| <input type="checkbox"/> 300-HWI/D4 | <input type="checkbox"/> 300-HWI/D6 |
| <input type="checkbox"/> 300-HWI/D443 | <input type="checkbox"/> 300-HWI/D643 |
| <input type="checkbox"/> 300-HWILF/D4 | <input type="checkbox"/> 300-HWILF/D6 |

Electrical

- | | |
|-------------------------------|-----------------------------------|
| <input type="checkbox"/> 120V | <input type="checkbox"/> 208–240V |
| <input type="checkbox"/> 230V | |

Control box cord location

- Back, standard
- Bottom, optional

Accessories (select all that apply)

- Pan divider bar—half-size/third-size (11318)
- Pan divider bar—full-size (16019)
- Pan divider bar—D443/D643 size (1012405)
- Locking kit (5020849)



- 3** Three full-size or GN 1/1 pans
6 Six half-size or GN 1/2 pans
9 D4: Nine third-size or GN 1/3 pans
12 D443: Twelve third-size or GN 1/3 pans
- D4: 72 lb [33 kg] product maximum; 43.5 qt [42 L] volume maximum
 D443: 96 lb [43,5 kg] product maximum; 56.6 qt [53,3 L] volume maximum

*Based on 4" deep pans. Will also accept 2-1/2" [65mm] deep pans; D6 hot wells will accept 6" [150mm] deep pans.



IP X3



300-HW Series

Specification

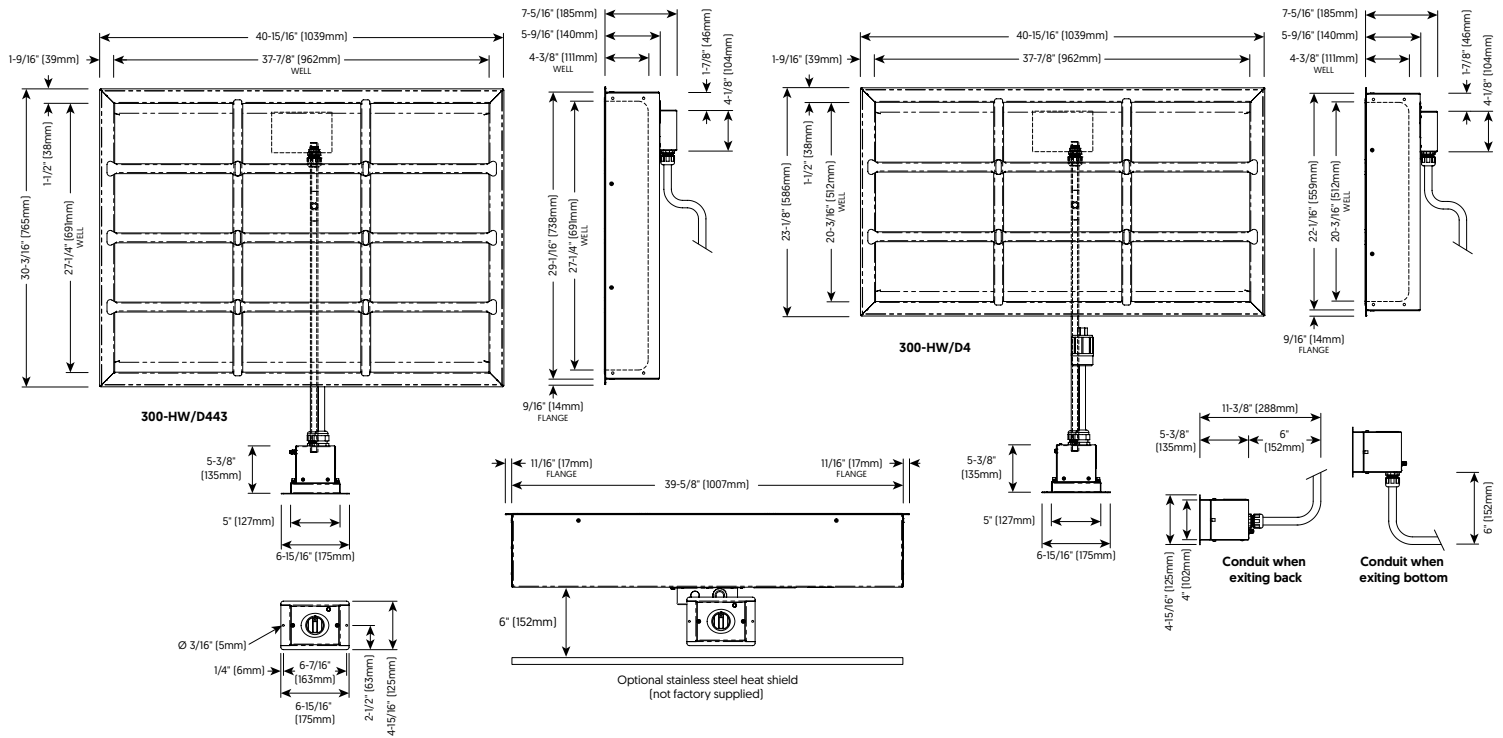

300-HWLF Series

Specification

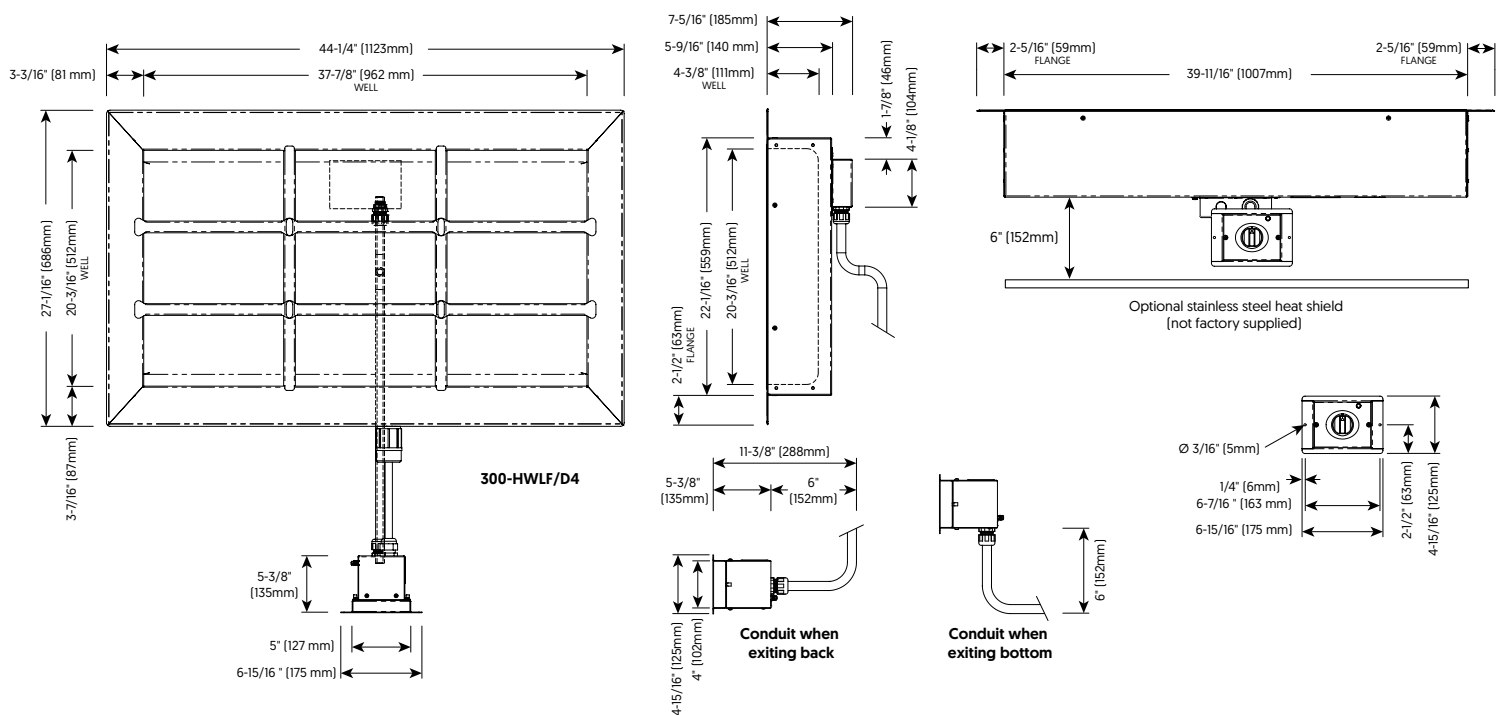

300-HWI Series

Specification

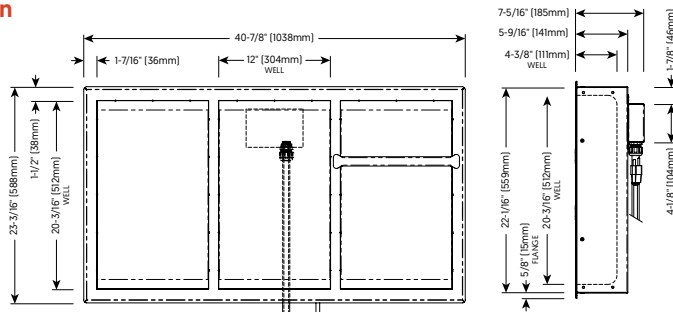

300-HWI/D4

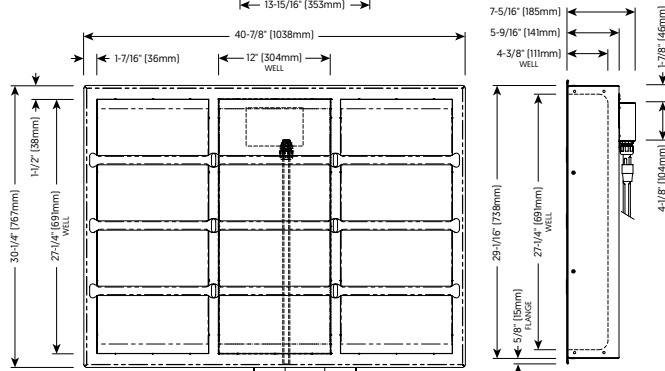
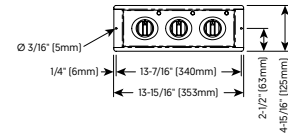
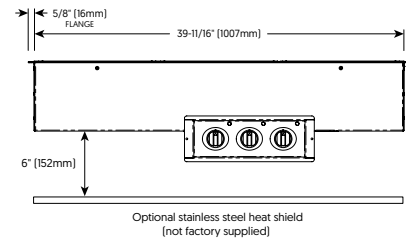
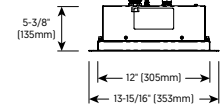

300-HWI/D443

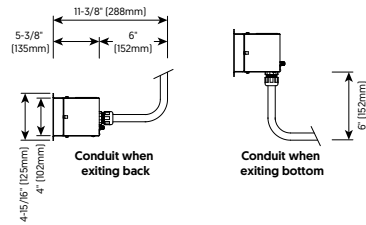
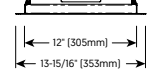

300-HWILF Series

Specification

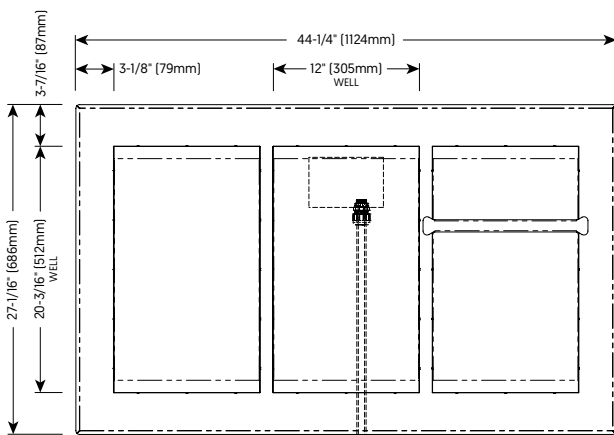

300-HWILF/D4

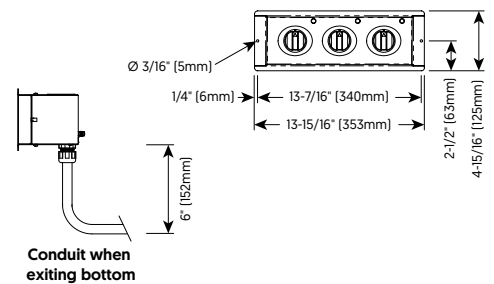
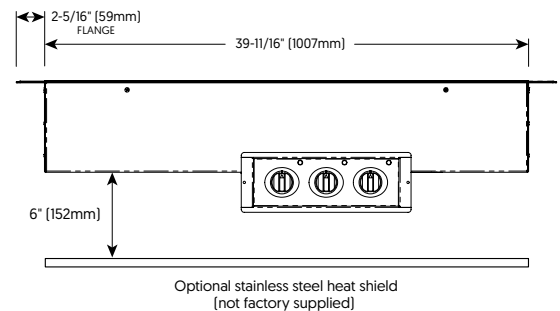
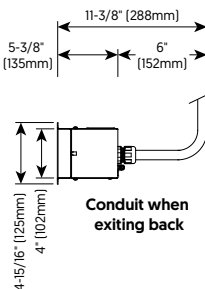
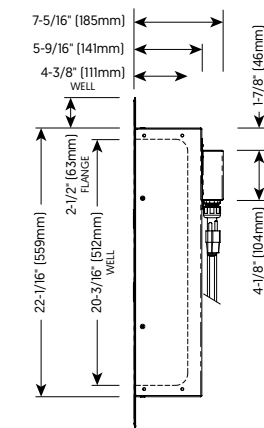
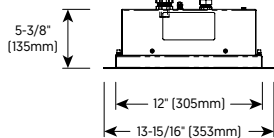

300-HW Series



DIMENSIONS

Model

300-HW/D4	7-5/16" x 40-15/16" x 23-1/8" [185mm x 1039mm x 586mm]
300-HW/D6	9-1/4" x 40-15/16" x 23-1/8" [234mm x 1039mm x 586mm]
300-HW/D443	7-5/16" x 40-15/16" x 30-3/16" [184mm x 1039mm x 765mm]
300-HW/D643	9-3/16" x 40-15/16" x 30-3/16" [233mm x 1039mm x 765mm]
300-HWLF/D4	7-5/16" x 44-1/4" x 27-1/16" [185mm x 1123mm x 686mm]
300-HWLF/D6	9-1/8" x 44-1/4" x 27-1/16" [232mm x 1123mm x 686mm]
300-HWI/D4	7-5/16" x 40-7/8" x 23-3/16" [185mm x 1038mm x 588mm]
300-HWI/D6	9-1/4" x 40-7/8" x 23-3/16" [234mm x 1038mm x 586mm]
300-HWI/D443	7-5/16" x 40-7/8" x 30-1/4" [185mm x 1038mm x 767mm]
300-HWI/D643	9-1/4" x 40-7/8" x 30-1/4" [234mm x 1038mm x 767mm]
300-HWILF/D4	7-5/16" x 44-1/4" x 27-1/16" [185mm x 1124mm x 686mm]
300-HWILF/D6	9-1/4" x 44-1/4" x 27-1/16" [234mm x 1124mm x 686mm]

Interior (H x W x D)

4-3/8" x 37-7/8" x 20-3/16" [111mm x 962mm x 512mm]
6-3/8" x 37-7/8" x 20-3/16" [162mm x 962mm x 512mm]
4-3/8" x 37-7/8" x 27-1/4" [111mm x 962mm x 691mm]
6-3/8" x 37-7/8" x 27-1/4" [162mm x 962mm x 691mm]
4-3/8" x 37-7/8" x 20-3/16" [111mm x 962mm x 512mm]
6-3/8" x 37-7/8" x 20-3/16" [162mm x 962mm x 512mm]
4-3/8" x 12" x 20-3/16" [111mm x 304mm x 512mm]
6-3/8" x 12" x 20-3/16" [162mm x 304mm x 512mm]
4-3/8" x 12" x 27-1/4" [111mm x 304mm x 691mm]
6-3/8" x 12" x 27-1/4" [162mm x 304mm x 691mm]
4-3/8" x 12" x 20-3/16" [111mm x 304mm x 512mm]
6-3/8" x 12" x 20-3/16" [162mm x 304mm x 512mm]

Model

Model	Net Weight	Ship Weight**
300-HW/D4	54.5 lb [25 kg]	128 lb [58 kg]
300-HW/D6	61 lb [28 kg]	160 lb [73 kg]
300-HW/D443	68 lb [31 kg]	128 lb [58 kg]
300-HW/D643	75 lb [34 kg]	160 lb [73 kg]
300-HWLF/D4	58 lb [26 kg]	Contact factory
300-HWLF/D6	64.5 lb [29 kg]	110 lb [50 kg]
300-HWI/D4	69 lb [31 kg]	117 lb [53 kg]
300-HWI/D6	77.5 lb [35 kg]	125 lb [57 kg]
300-HWI/D443	85 lb [39 kg]	Contact factory
300-HWI/D643	99 lb [45 kg]	Contact factory
300-HWILF/D4	74 lb [34 kg]	135 lb [61 kg]
300-HWILF/D6	83 lb [38 kg]	125 lb [57 kg]

Ship Dimensions (L x W x H)**

49" x 34" x 15" [1245mm x 864mm x 381mm]
49" x 34" x 15" [1245mm x 864mm x 381mm]
49" x 34" x 15" [1245mm x 864mm x 381mm]
49" x 34" x 15" [1245mm x 864mm x 381mm]
Contact factory
49" x 34" x 15" [1245mm x 864mm x 381mm]
49" x 34" x 15" [1245mm x 864mm x 381mm]
49" x 34" x 15" [1245mm x 864mm x 381mm]
Contact factory
Contact factory
49" x 34" x 15" [1245mm x 864mm x 381mm]
49" x 34" x 15" [1245mm x 864mm x 381mm]

**Domestic ground shipping information. Contact factory for export weight and dimensions.

Cutout Dimensions

Model	Non-combustible Surface Cutout (L x W)	Combustible Surface Cutout (L x W)^A	Control Box Cutout (H x W x D)*
300-HW/D4	39-13/16" x 22-1/8" [1011mm x 562mm]	---	4-1/4" x 5-1/4" x 11-3/8" [108mm x 133mm x 288mm]
300-HW/D6	39-13/16" x 22-1/8" [1011mm x 562mm]	---	4-1/4" x 5-1/4" x 11-3/8" [108mm x 133mm x 288mm]
300-HW/D443	39-13/16" x 29-1/8" [1011mm x 741mm]	---	4-1/4" x 5-1/4" x 11-3/8" [108mm x 133mm x 288mm]
300-HW/D643	39-13/16" x 29-1/8" [1011mm x 741mm]	---	4-1/4" x 5-1/4" x 11-3/8" [108mm x 133mm x 288mm]
300-HWLF/D4	39-13/16" x 22-1/8" [1011mm x 562mm]	41-13/16" x 24-1/8" [1062mm x 613mm]	4-1/4" x 5-1/4" x 11-3/8" [108mm x 133mm x 288mm]
300-HWLF/D6	39-13/16" x 22-1/8" [1011mm x 562mm]	41-13/16" x 24-1/8" [1062mm x 613mm]	4-1/4" x 5-1/4" x 11-3/8" [108mm x 133mm x 288mm]
300-HWI/D4	39-13/16" x 22-1/8" [1011mm x 562mm]	---	4-1/4" x 12-3/4" x 11-3/8" [108mm x 324mm x 288mm]
300-HWI/D6	39-13/16" x 22-1/8" [1011mm x 562mm]	---	4-1/4" x 12-3/4" x 11-3/8" [108mm x 324mm x 288mm]
300-HWI/D443	39-13/16" x 29-1/8" [1011mm x 741mm]	---	4-1/4" x 12-3/4" x 11-3/8" [108mm x 324mm x 288mm]
300-HWI/D643	39-13/16" x 29-1/8" [1011mm x 741mm]	---	4-1/4" x 12-3/4" x 11-3/8" [108mm x 324mm x 288mm]
300-HWILF/D4	39-13/16" x 22-1/8" [1011mm x 562mm]	41-13/16" x 24-1/8" [1062mm x 613mm]	4-1/4" x 12-3/4" x 11-3/8" [108mm x 324mm x 288mm]
300-HWILF/D6	39-13/16" x 22-1/8" [1011mm x 562mm]	41-13/16" x 24-1/8" [1062mm x 613mm]	4-1/4" x 12-3/4" x 11-3/8" [108mm x 324mm x 288mm]

^Large flange wells only.

*Allow 6" [152mm] clearance from control box to conduit bend.



CHECK FIRST

- Appliance must be installed level and must not be installed in any area where it may be directly affected by steam, grease, dripping water, high temperatures, or any other severely adverse conditions.
- Some foods may require additional overhead heating. Always monitor the food temperature and add overhead heating when needed.
- Countertop material must withstand temperatures up to 200°F [93°C].
- A stainless steel heat shield is recommended if the area under the appliance is used for storage.

300-HW Series



Heat of rejection

300-HW	Heat Gain qs, BTU/hr	Heat Gain qs, kW
	243	0.07



1" [25 mm] from
combustible surfaces



Model	V	Ph	Hz	A	kW	Cord & Plug
300-HW/D4 and /D6, 300-HWLF/D4 and /D6, 300-HWI/D4 and /D6, 300-HWILF/D4 and /D6	120V	120	1	50/60	15.0	1.8 NEMA 5-20p 20A-125V plug
	208–240V	208	1	50/60	6.5	1.4 NEMA 6-15p 15A-250V plug [U.S.A. only]
		240	1	50/60	7.5	1.8
230V	230	1	50/60	7.8	1.8	CEE 7/7 plug rated 250V CH2-16p plug rated 250V BS 1363 [U.K. only] plug rated 250V
300-HW/D443, 300-HW/D643, 300-HWI/D443, 300-HWI/D643	120V	120	1	50/60	20.3	2.4 NEMA L5-30p 30A-125V plug
	208–240V	208	1	50/60	8.8	1.8 NEMA 6-15p 15A-250V plug [U.S.A. only]
		240	1	50/60	10.1	2.4
230V	230	1	50/60	10.6	2.4	CEE 7/7 plug rated 250V CH2-16p plug rated 250V BS 1363 [U.K. only] plug rated 250V

Cord length: 120V: 6 ft [1.8 m]; 208–240V: 9 ft [2.7 m]; 230V [CEE]: 9 ft [2.7 m];
230V [CH, BS]: 8 ft [2.5 m]

CONTACT US

W164 N9221 Water Street | Menomonee Falls, Wisconsin 53051 | U.S.A.
Phone: 262.251.3800 | 800.558.8744 U.S.A./Canada | Fax: 262.251.7067 | alto-shaam.com