

**PLAN VIEW**  
RIGHT HINGE  
SELECT

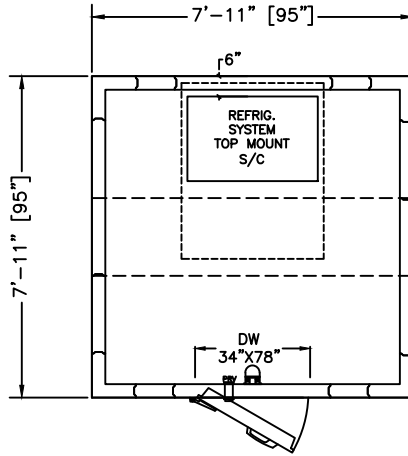

**PLAN VIEW**  
LEFT HINGE  
SELECT

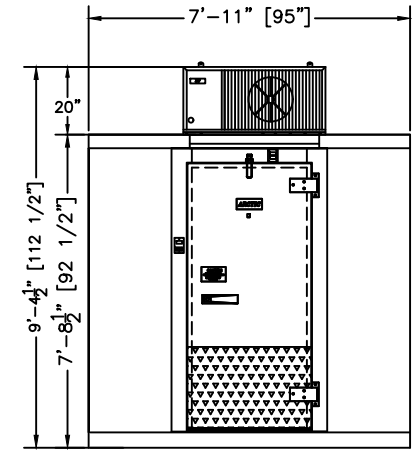

**ELEVATION**  
RIGHT HINGE

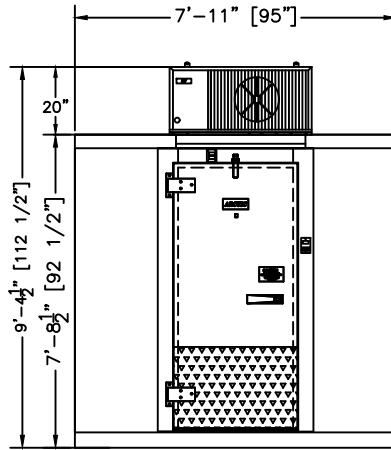

**ELEVATION**  
LEFT HINGE

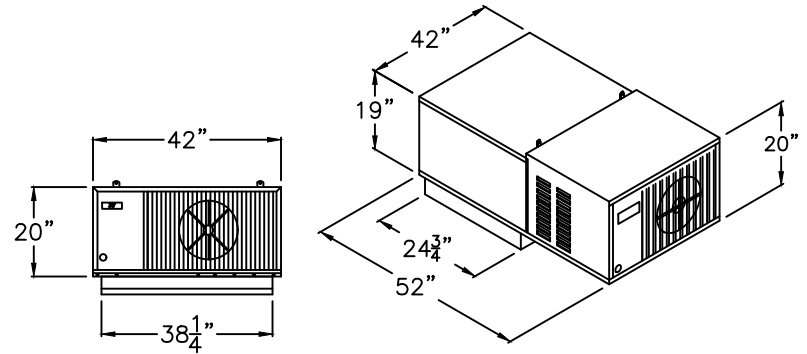

**REFRIGERATION UNIT**

PRODUCT SPECIFICATIONS	
MODEL:	BL88-F-SC
WALK-IN SPECIFICATION	
INTERIOR/EXTERIOR FINISH	26 GAUGE MILL EMBOSSED ACRYLUME OR 26 GAUGE STUCCO EMBOSSED GALVANIZED STEEL
ELECTRICAL (VOLTS/Hz/PH)	115/60/1
MAX AMP.	2.2
SYSTEM SPECIFICATION	
ELECTRICAL (VOLTS/Hz/PH)	208-230/60/1
AMPS	16.7
WEIGHT (LBS)	275
CORD + NEMA 6-20R PLUG	
WALK-IN AND REFRIGERATION FREIGHT	
TOTAL SHIPPING WEIGHT (LBS)	1323
MAXIMUM PALLET SIZE	48" X 96" X 102" HIGH
NUMBERS OF PALLETS	2

MODEL: BL88-F-SC  
 INDOOR-WITH FLOOR  
 FREEZER -10°F  
 SELF-CONTAINED SYSTEM

CUSTOMER APPROVAL

DATE: \_\_\_\_\_  
 SIGNATURE: \_\_\_\_\_

**CONFIDENTIAL**

THE DRAWINGS, TECHNICAL DATA, AND ALL OTHER INFORMATION SET FORTH IN THIS DOCUMENT COMPRISE TRADE SECRETS AND CONFIDENTIAL INFORMATION THAT IS THE EXCLUSIVE PROPERTY OF ARCTIC INDUSTRIES, LLC.

USE OF SUCH INFORMATION IS LIMITED TO THE PURPOSE FOR WHICH IT WAS PROVIDED AND NO RECIPIENT IS PERMITTED TO USE, COPY, OR DISCLOSE SUCH INFORMATION EXCEPT AS EXPRESSLY AUTHORIZED BY ARCTIC INDUSTRIES, LLC.