



Exhaust and Transfer Fans

Engineering Simplicity into Kitchen Ventilation Systems



Quality doesn't have to be complicated.

When building out a commercial kitchen, you don't need complexity. You need answers. At Accurex®, we do the hard work for you. Everything we do—from engineering to aftermarket service—is designed to make it easy for you to succeed.

Simplicity in every system.

When it comes to ventilation systems, we never stop improving. Through extensive prototype modeling, we create products that have higher efficiencies with lower installation and operating costs. And everything we create is built to be fully integrated throughout your kitchen. Easy to install, operate and maintain. Now that's worry-free simplicity, day in and day out.

Select. Design. Done.

No matter if you're creating an expansive commercial kitchen or starting a small business, Accurex products are designed to fit all your ventilation needs. Our professionals along with our computer-aided product selection program CAPS® help you select, configure and view real-time drawings. We then build and deliver your entire ventilation system quickly and efficiently, with an eye for exacting quality.















One source. One call.

We are a Greenheck Group company, the world's leading manufacturer of commercial air movement, control and conditioning equipment. You can rest easy knowing you're sourcing from one trusted provider. Just call or email an Accurex representative and you're on your way to a complete kitchen ventilation system. It's that easy.



Engineered to work. Built to last.

Long before installation, our products undergo comprehensive testing. This includes structural integrity, aerodynamic performance, sound levels, mechanical operation, vibration, environmental impact, and more. Accurex products carry several certifications including AMCA, UL, NSF, and ETL. That not only means a more comfortable environment for workers and customers. It also means ventilation you can rely on now and well into the future.

MODEL		DESCRIPTION	DRIVE	MAXIMUM CFM	MAXIMUM STATIC PRESSURE	PAGE
XRUD		Roof Upblast and Sidewall Exhaust Fan, Galv/Alum	Direct	6,500	3 in. wg	4-12
XCUE		Roof Upblast and Sidewall Exhaust Fan, Alum	Direct	14,700	3 in. wg	4-12
XCUBE		Roof Upblast and Sidewall Exhaust Fan	Belt	30,000	5 in. wg	4-12
XRUBS		Roof Upblast Severe Duty Exhaust Fan	Belt	6,800	3.25 in. wg	4-12
XID		Indoor Mounted Non-Grease Transfer Fan	Direct	5,000	2 in. wg	13-26
XIB		Indoor Mounted Non-Grease Transfer Fan	Belt	27,000	4 in. wg	13-26
XQEI		Indoor or Outdoor Mounted Inline Exhaust Fan	Belt	116,000	8 in. wg	13-26
XTIF		Indoor or Outdoor Mounted Inline Exhaust Fan	Belt	26,000	4 in. wg	13-26
XUEF		Indoor or Outdoor Mounted Utility Set Exhaust Fan	Belt/Direct	230,000	21 in. wg	27-37
XRED		Roof Mounted Non-Grease Downblast Exhaust Fan	Direct	14,500	2.75 in. wg	38-46
XREB		Roof Mounted Non-Grease Downblast Exhaust Fan	Belt	44,700	3.25 in. wg	38-46
XCR		Indoor Ceiling Mounted Restroom Exhaust Fan	Direct	1,600	1 in. wg	47-59
XIR		Indoor Ceiling or Inline Mounted Restroom Exhaust Fan	Direct	3,800	1 in. wg	47-59
		Roof Curbs				60-63

Roof Upblast and Sidewall Exhaust



ROOF UPBLAST AND SIDEWALL EXHAUST OFFER THE FOLLOWING BENEFITS:

- Industry’s best performance and durability for general clean air, high grease and other contaminant applications (as found in food service and fume hood exhaust)
- All fan sizes are tested in our AMCA Accredited laboratory, and all models are licensed to bear the AMCA Sound and Air Performance seal
- Leakproof construction for the entire life of the fan, utilizing a one-piece windband trapping grease and protecting the roof/wall
- Broadest performance in the industry, up to 5 in. wg (1,245 Pa) and 30,000 cfm (50,970 m3/hr)
- Most advanced motor cooling of any fan in its class
- Seismic Certification IBC 2015. OSHPD/OSP Certification
- Certified to High Wind and Hurricane standards. NOA and FLPA Certified

MODEL OVERVIEW

Both, roof upblast and sidewall configuration, are specifically designed to discharge air directly away from the mounting surface.

MODEL NUMBER CODE:

The Model Number Code is designed to completely identify the fan. The correct code letters must be specified to designate belt or direct drive, and roof or sidewall mounted configurations. The remainder of the model number is determined by the size and performance.

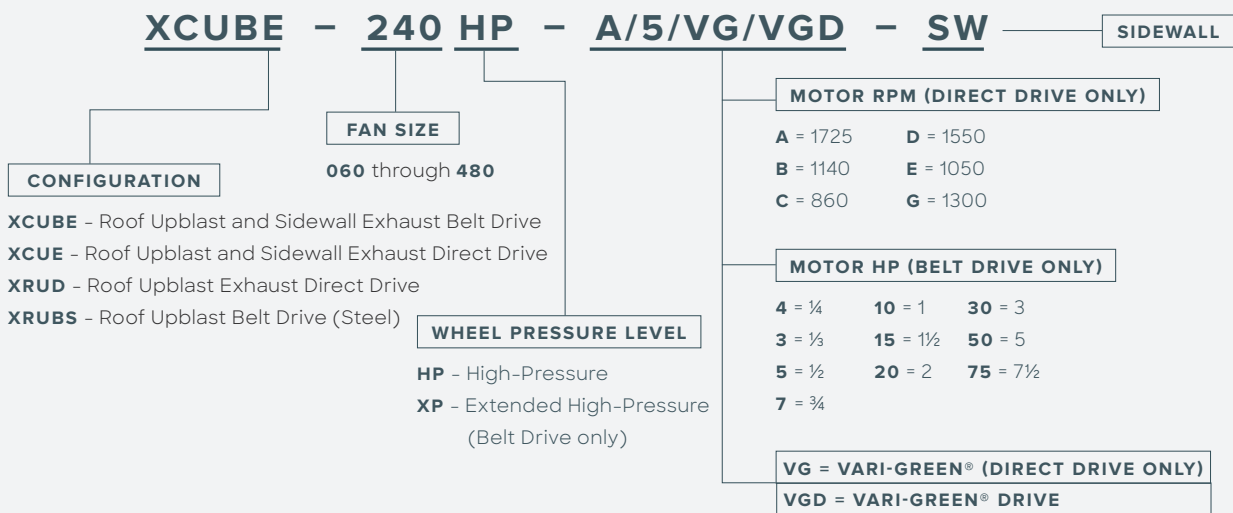

XRUD – Direct Drive

Model XRUD galvanized/aluminum direct drive upblast centrifugal exhaust fans are specifically designed for roof or wall mounted applications. Exhaust air is upward/away from the roof/wall surface. Performance capabilities range from 60 to 6,500 cfm (102 to 11,044 m³/hr) and up to 3 in. wg (745 Pa) of static pressure. Maximum continuous operating temperature is 400°F



XCUE – Direct Drive

Model XCUE aluminum direct drive upblast centrifugal exhaust fans are specifically designed for roof or wall mounted applications. Exhaust air is upward/away from the roof/wall surface. Performance capabilities range from 70 to 14,700 cfm (119 to 24,975 m³/hr) and up to 3 in. wg (745 Pa) of static pressure. Maximum continuous operating temperature is 400°F (204°C). Seismic certified to size 200. NOA and FLPA certified to size 200.

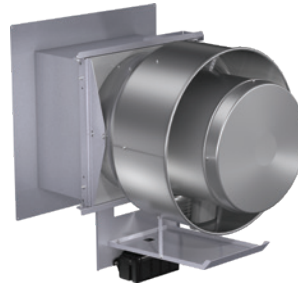

XCUBE – Belt Drive

Model XCUBE belt drive upblast centrifugal exhaust fans are specifically designed for roof or wall mounted applications. Exhaust air is discharged directly upward/away from the roof/wall surface. Performance capabilities range from 200 to 30,000 cfm (339 to 50,970 m³/hr) and up to 5 in. wg (1,242 Pa) of static pressure. Maximum continuous operating temperature is 400°F (204°C). Seismic certified to size 480. NOA and FLPA certified to size 300.



XRUBS – Belt Drive

Model XRUBS is used for heavy grease exhaust applications as found in charbroilers, solid fuel cooking and oriental cooking. All sizes are UL Listed for commercial cooking applications and capable of 400°F (204°C) continuous operation. The entire unit is constructed of heavy-gauge steel and has a centrifugal backward-inclined steel wheel. Unit includes: clean out port, non-stick coated wheel, heat baffle, and a NEMA-3R disconnect switch. Performance up to 3.25 in. wg (807 Pa) and 6,800 cfm (11,553 m³/hr).



- 1 **Wheel** – Backward-inclined, non-overloading centrifugal wheel is utilized to generate high-efficiency and minimal sound. Wheel cones are carefully matched to the venturi for maximum efficiency. Each wheel is statically and dynamically balanced, for long life and quiet operation.
- 2 **Disconnect Switch** – NEMA-3R switch is factory mounted and wiring is provided from the motor as standard (other switches are available). All wiring and electrical components comply with the National Electrical Codes (NEC) and are either UL/cUL Listed or Recognized.
- 3 **Fan Shaft** – Precisely sized, ground, and polished so the first critical speed is at least 25% over the maximum operating speed. Close tolerances, where the shaft makes contact with bearings, results in longer bearing life.
- 4 **Bearings** – 100% factory tested and designed specifically for air handling applications with a minimum L10 life in excess of 100,000 hours (L50 average life of 500,000 hours).
- 5 **Motor** – Carefully matched to the fan load and mounted out of the airstream.
- 6 **Motor Cover** – Aluminum construction(XCUE/XCUBE only). Stainless steel fasteners are attached for easy removal and access to the motor compartment and drive assembly.
- 7 **Stainless Steel Fasteners** – Allows for easy removal and access to the motor compartment and drive assembly.
- 8 **Motor Cooling** – Cooling fins located on top of the fan wheel draw outside air through a large breather tube, directly into the motor compartment. Positive motor cooling with fresh air results in maximum motor life.

- 9 **Lifting Points** – Select models have various lifting points located on the drive frame and bearing plates.
- 10 **Vibration Isolation** – True vibration isolators contain two independent studs with rubber neoprene to support the drive assembly and wheel for long life and quiet operation. No steel-on-steel contact.
- 11 **Drive Assembly** – Belts, pulleys and keys are oversized by 150% of driven horsepower. Machined cast pulleys are adjustable for final system balancing. Belts are static-free and oil-resistant.
- 12 **Windband** – One-piece, heavy-gauge aluminum, with a rolled bead for extra strength, directs exhaust air away from the mounting surface.
- 13 **Leakproof Construction** – One-piece windband is continuously welded to the curb cap for leakproof protection on XCUE and XCUBE, sizes 099 through 300 and all sizes with UL/cUL 762. XRUD models utilize leakproof brazed junction.
- 14 **Mounting Holes** – Aluminum curb cap has pre-punched mounting holes to ensure correct attachment to the roof.
- 15 **Drain Trough** – Allows for one-point drainage of water, grease and other residue.

Internal Conduit Chase (not shown) – For easy internal electrical wiring in applications not subject to NFPA.

Name Plate (not shown) – Permanent stamped aluminum plate for exact model and serial identification number.

Seismic Certification – Certified to IBC 2015, ASCE 7-10 and California OSHPD certification standards for all seismic design categories. OSHPD OSP# 0148-10, SDS Value 2.28, Maximum Certification Size 480 (XCUE/XCUBE only).

High Wind /Hurricane Zone Certification – Miami-Dade NOA for high wind and hurricane zones.

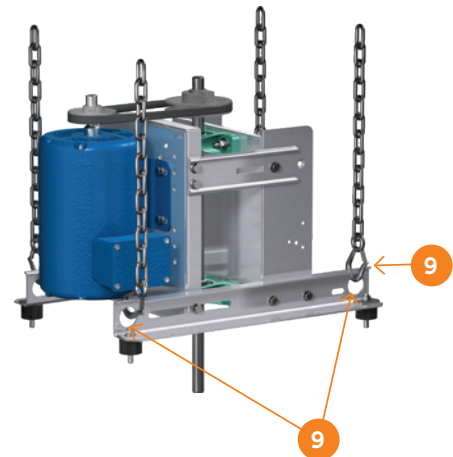
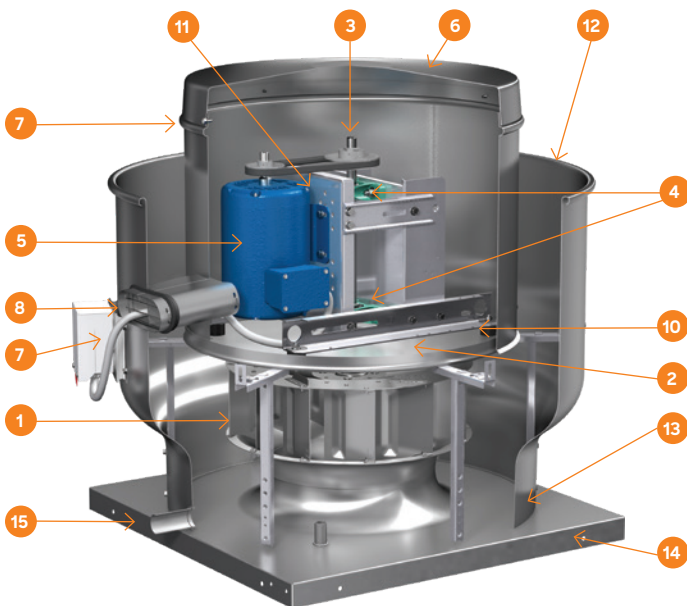

STANDARD CONSTRUCTION FEATURES-XRUBS

- 1 **Shaft** – Precisely sized, ground, and polished so the first critical speed is at least 25% over the maximum operating speed. Close tolerances, where the shaft makes contact with bearings, results in longer bearing life.
- 2 **Bearings** – 100% factory tested and designed specifically for air handling applications with a minimum L10 life in excess of 100,000 hours (L50 average life of 500,000 hours).
- 3 **True Vibration Isolation** – True vibration isolators contain two independent studs with rubber neoprene to support the drive assembly and wheel for long life and quiet operation. No steel-on-steel contact.
- 4 **Clean Out Port** – Allows the outside of the wheel to be cleaned through a 4 inch diameter removable plug in the windband.
- 5 **Non-Stick Coated Steel Wheel** – Heavyweight steel wheel with a non-stick coating eliminates imbalance in heavy grease applications. The steel wheel is a backward inclined, non-overloading centrifugal type.
- 6 **Drain Trough** – Allows for one-point drainage of water, grease and other residue.
- 7 **Curb Cap with Mounting Holes** – Steel curb cap has pre-punched mounting holes to ensure correct attachment to the roof.
- 8 **Hinged Kit** – Allows maintenance personnel to hinge the entire fan up to gain access to wheel ductwork for regular inspection and cleaning.

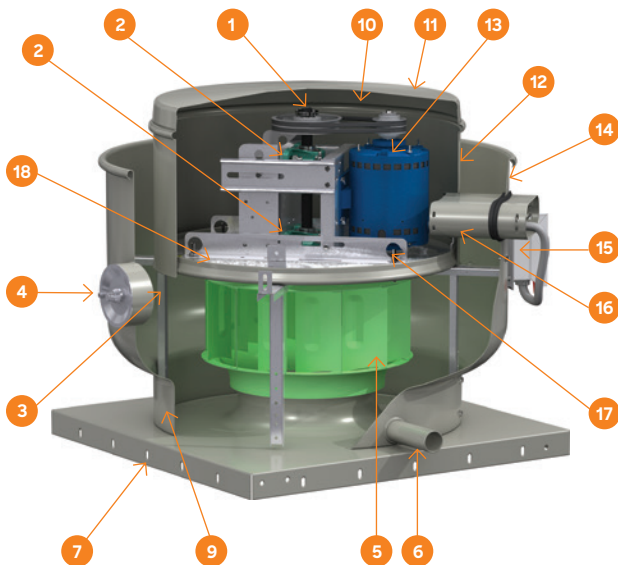

- 9 **Leakproof Construction** – One-piece windband is continuously welded to the curb cap for leakproof protection.
- 10 **Drive Assembly** – Dual belts, pulleys and keys are oversized 150% of driven horsepower. Machined cast steel pulleys are adjustable for final system balancing. Belts are static-free and oil-resistant.
- 11 **Motor Cover** – Steel construction. Stainless steel fasteners are attached for easy removal and access to the motor compartment and drive assembly.
- 12 **Permatector™ Coating** – Unit is constructed of a minimum of 16-gauge steel. Entire unit is powder coated with chemical-resistant Permatector™ finish.
- 13 **Motor** – Carefully matched to the fan load and mounted out of the airstream.
- 14 **Windband** – Uniquely spun one-piece steel windband with a rolled bead for extra strength. Windband directs exhaust air away from the mounting surface.
- 15 **NEMA-3R Disconnect Switch Mounted & Wired** – All wiring and electrical components comply with the National Electrical Code (NEC) and are either UL/cUL Listed or Recognized.
- 16 **Motor Cooling** – Cooling fins located on top of the fan wheel draw outside air through a large breather tube, directly into the motor compartment. Positive motor cooling with fresh air results in maximum motor life.
- 17 **Lifting Points** – Select models have various lifting points located on the drive frame and bearing plates.

Name Plate (not shown) – Permanent stamped aluminum plate for exact model and serial identification number.

Heat Baffle (not shown) – Extends motor life by reducing the amount of heat through the bottom of the motor support pan.



ROOF CURBS

Wide variety of roof curbs are available for mounting the fan to the roof, including: vented, flanged, pitched, and sound-absorbing.



VENTED CURB EXTENSIONS

Mounts between roof curb and roof mounted fans to meet NFPA requirements of 40 in. (101.6 cm) minimum discharge above the roof when mounted on a minimum 8 in. (20.32 cm) high roof curb.



DISCONNECT SWITCHES

Assorted NEMA rated switches are available for positive electrical shutoff and safety, including: dust-tight, rainproof and corrosion-resistant.

HINGE KIT

Allows maintenance personnel to hinge the entire fan up to gain access to wheel and ductwork for regular inspection and cleaning.



GREASE TRAP

Polypropylene trap designed to collect grease residue to avoid drainage onto roof surface.

GREASE TRAP WITH ABSORBENT MATERIAL

Same as above, with an absorbent material to collect grease residue for easy disposal.

WINDBAND EXTENSION

Aluminum tube raises fan's discharge an additional 12"-54", depending on fan size for special code requirements.

NON-STICK WHEEL

Patented coating helps prevent wheel imbalance in heavy grease applications and allows build-up on wheel to be easily removed. Patent No. 5,809,993.

GREENHECK

VARI-GREEN® MOTOR

1/15 - 10 hp high efficiency electronically commutated motors with built-in speed control capability available for direct drive fans with 115, 208-230, 277V, or 50/460 Hz, single-phase power.



COATINGS

Wide variety of coatings and colors are available for decorative to acidic applications.

Permatector™ is our standard coating, typically used for applications that require corrosion resistance in indoor and outdoor environments.

Hi-Pro Polyester is resistant to saltwater, chemical fumes and moisture within more corrosive atmospheres and come in seven standard colors.

CLEAN OUT PORT

Patented removable plug allows for easy spray or steam cleaning of wheel through the windband. Patent No. 5,809,993.

BIRDSCREEN

Rigid wire to protect the fan's discharge from birds or small objects.

CURB SEAL

Foam or high temperature seal between fan and curb to ensure proper sealing when attached to a curb.

DAMPERS

Designed to prevent outside air from entering back into the building when fan is off. Includes: backdraft and motorized dampers.

Not available with UL/cUL 762.



GREENHECK VARI-GREEN® CONTROLS

Remote mounted dial, two-speed control, touch remote, temperature/humidity, volatile organic compounds, transformer and constant pressure for applications such as bathrooms, dryers, filters, etc.



COMMERCIAL KITCHEN (GREASE)

Sizes 099 and larger are designed to meet restaurant and food service applications. These fans are UL/cUL 762 Listed for grease removal and have been tested under high temperature [400°F (204°C)] and abnormal flare-up [600°F (316°C)] conditions.

Due to high temperatures and grease-laden airstreams in commercial kitchen ventilation, system designers must be aware of governing codes and guidelines. The National Fire Protection Association (NFPA) is the primary source upon which many codes for commercial kitchen’s ventilation are based. Selected information from NFPA is shown below. Local code authorities should be consulted before proceeding with any kitchen ventilation project.

- Exhaust fans used in kitchen ventilation applications must have external wiring (wiring must not be installed in the airstream).
- Installation must include a means for inspecting, cleaning and servicing the exhaust fan (e.g. hinged curb cap).
- No dampers are to be installed in the system.

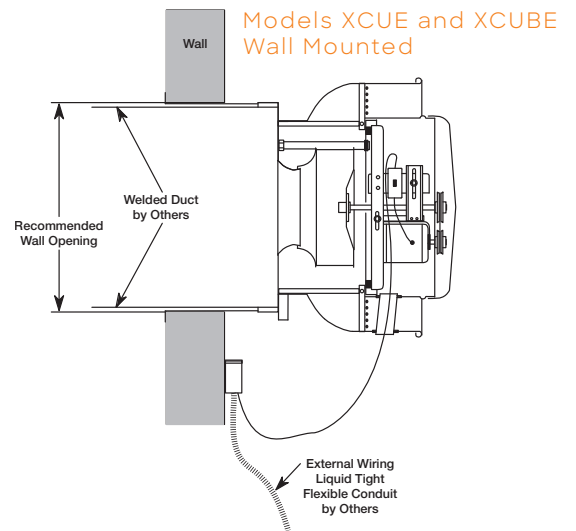
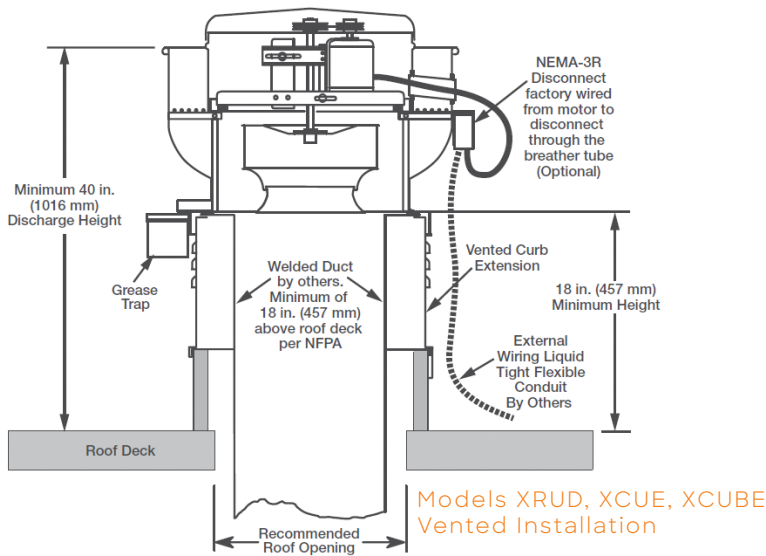

GENERAL CLEAN AIR OR FUME HOOD (NON-GREASE)

Exhaust fans are designed for applications ranging from clean air to contaminated air. A typical installation is shown. Sizes 095 and smaller can handle temperatures up to 160°F (71°C).

Note:
Installation recommendation is based on national codes. Local authority may supersede these recommendations.

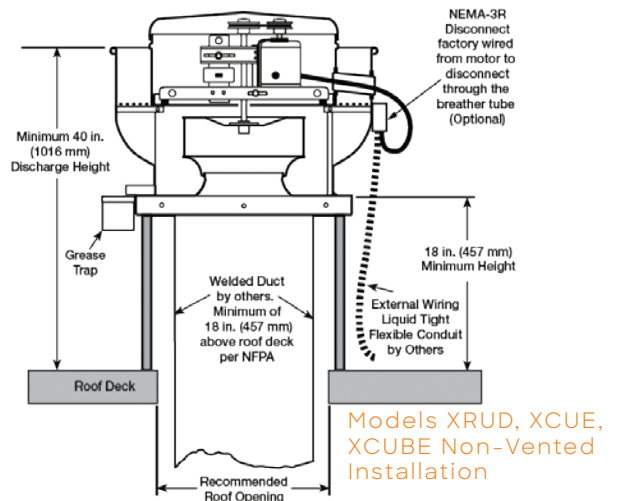

OPTIONS GUIDE

OPTIONS AND ACCESSORIES	XCUBE	XCUE	XRUBS	XRUD
Roof Curbs	Optional	Optional	Optional	Optional
Vented Curb Extensions	Optional	Optional	Optional	Optional
Disconnect Switches	Standard	Standard	Standard	NEMA-3R Only
Hinge Kit	Optional	Optional	Standard	Standard
Grease Trap	Optional	Optional	Optional	Optional
Grease Trap with Absorbent Material	Optional	Optional	Optional	-
Non-Stick Wheel	Optional	Optional	Standard	-
Windband Extension	Optional	Optional	Optional	Optional
Coatings	Optional	Optional	Standard	-
Clean Out Port	Optional	Optional	Standard	Optional
Birdscreen	Optional	Optional	-	-
Curb Seal	Optional	Optional	Standard	Optional
Dampers	Optional	Optional	-	-
Speed Controllers	-	Optional	-	-
Greenheck Vari-Green Motor	-	Optional	-	Size Dependent
Greenheck Vari-Green Controls	Optional	Optional	-	-
Greenheck Vari-Green Drive	Optional	Optional	-	-

Inline Fans



XID and XIB

- Centrifugal backward-inclined belt or direct drive fans
- Performance range: 30 to 27,000 cfm (51-45,873 m3/hr)
- Static pressure: Up to 4.0 in. wg (993 Pa)
- Maximum operating temperature: 180°F (82°C)

XQEI

- Performance range: 500 to 116,000 cfm (850 to 197,000 m3/hr)
- Static pressure: Up to 5 in. wg (1245 Pa) Class I
- Up to 8 in. wg (1990 Pa) Class II
- Maximum operating temperature: 200°F (93°C)
- Units are available for mounting in horizontal or vertical for installations
- Motor positions can be rotated in the field. Fans are available in 17 sizes, 9 through 60 inches

XIB AND XID MODEL OVERVIEW

Designed for clean air applications (intake, exhaust, return, or make-up air systems), where space is a prime consideration.

XQEI MODEL OVERVIEW

Uses a mixed flow wheel for quiet operation with high efficiencies in low to medium pressure ducted systems.

MODEL NUMBER CODE: The Model Number Code is designed to completely identify the fan. The correct code letters must be specified to designate belt or direct drive and to inline fans. The remainder of the model number is determined by the size and performance.

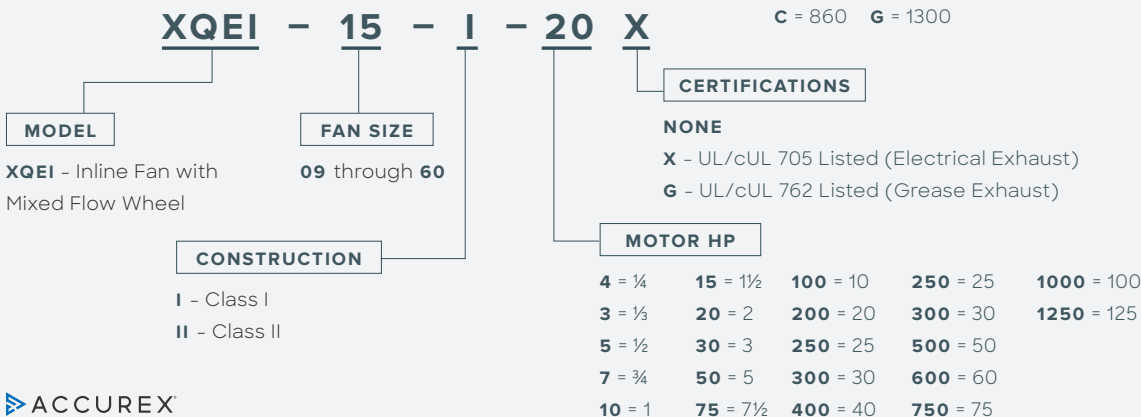
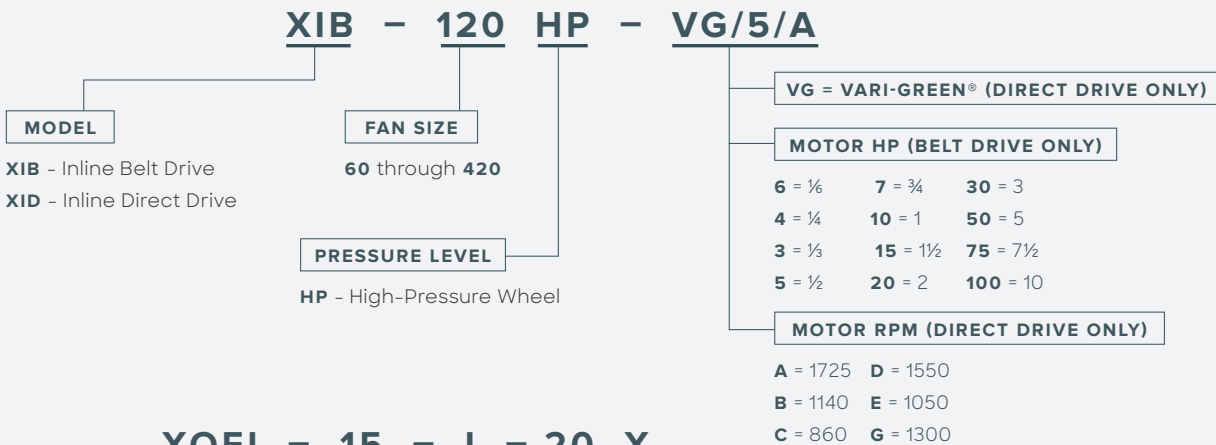

XTIF

- Inline centrifugal fans
- Performance range: 300 to 26,000 cfm (500 to 44,200 m3/hr)
- Static pressure: Up to 4.0 in. wg (993 Pa)
- Maximum operating temperature: 200°F (93°C)
- All XTIF products are belt driven with motors out of the airstream to prevent grease buildup
- Housings are constructed of welded steel or aluminum (optional), and are suitable for indoor or outdoor applications
- The backward-inclined wheels are manufactured from aluminum and are suitable for clean air and restaurant exhaust applications

XTIF MODEL OVERVIEW

Designed for ducted inline installations, Accurex tubular centrifugal fans provide quiet, efficient and reliable air performance.

MODEL NUMBER CODE: The Model Number Code is designed to completely identify the fan. The correct code letters must be specified to designate belt or direct drive and to inline fans. The remainder of the model number is determined by the size and performance.

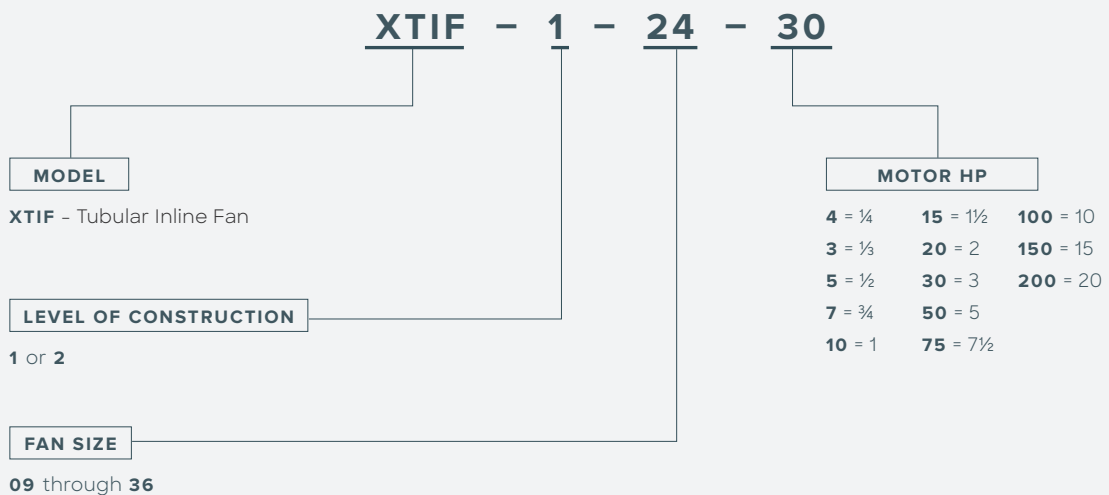

XID and XIB - Inline Fan

Accurex's model XIB and XID centrifugal inline fans feature a unique combination of installation flexibility, rugged construction, ease of service, high-efficiency and low sound levels. These compact inline fans are the ideal selection for indoor clean air applications (including intake, exhaust, return, or make-up air systems), where space is a prime consideration. Installation costs are reduced because the need for costly square-to-round transition pieces are eliminated. The square housing design, compact size and straight through airflow give the system designer the flexibility to mount XIB and XID fans horizontal, vertical or at any angle. XIB and XID fans offer the broadest performance in the industry, up to 4 in. wg (993 Pa) and 27,000 cfm (45,873 m3/hr).

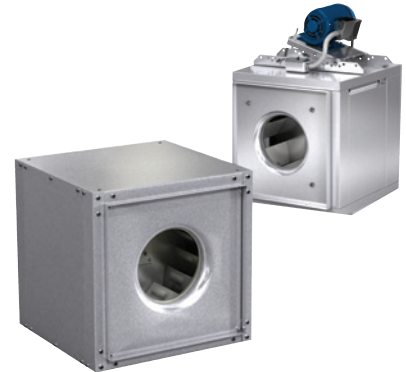

Note: Not rated for contaminated air applications.

TYPICAL APPLICATIONS INCLUDE:

- General exhaust
- Transfer air
- General supply

XQEI - Inline Fan

A belt drive model with premium levels of construction and performance. XQEI utilizes a mixed flow wheel and air straightening vanes for higher efficiencies, lower horsepower and lower sound levels. Often used in commercial and industrial applications such as libraries, theaters, garages - involving everything from clean air to grease exhaust to high temperatures.



TYPICAL APPLICATIONS INCLUDE:

- Restaurant grease exhaust
- Fume hood exhaust (special coatings available)
- General exhaust or supply
- Combustion air
- Industrial space ventilation
- Roof exhaust or supply (with weatherhood)

XTIF - Inline Fan

Model XTIF inline fan is the ideal choice for ducted systems. Accurex's standard fan can be mounted in any position from horizontal to vertical, allowing installation in the smallest possible space, at the lowest installation cost. The centrifugal wheel used in this design provides higher efficiencies and lower sound levels than propeller type inline fans when used in medium-pressure ducted systems. XTIF fans are available in either painted steel or aluminum construction.



TYPICAL APPLICATIONS INCLUDE:

- Restaurant grease exhaust
- Fume hood exhaust (special coatings available)
- General exhaust or supply
- Combustion air
- Industrial space ventilation
- Roof exhaust or supply (with weatherhood)

STANDARD CONSTRUCTION FEATURES

- 1 Cabinet Construction** – The fan housing is constructed of rigid structural members and formed galvanized steel panels. Aluminum construction is optional in all XIB sizes 70-300 and XID sizes 60-160.
- 2 Wheel** – An aluminum, backward-inclined, non-overloading, centrifugal wheel is utilized to deliver maximum efficiency. Each wheel is statically and dynamically balanced.
- 3 Duct Collars** – Inlet and discharge duct collars are provided for easy duct connection. The square design also provides a larger discharge area than tubular centrifugal and vane axial fans, so outlet velocities are reduced for quieter operation.
- 4 Drive Frame** – Constructed from heavy-gauge steel. Belt adjustment is accomplished by loosening fasteners, sliding the motor plate and re-tightening fasteners.
- 5 Motor** – Permanently lubricated, sealed ball bearing motors are selected to provide years of trouble-free operation with minimal maintenance.
- 6 Bearings** – 100% factory tested and designed specifically for air handling applications with a minimum L10 life in excess of 100,000 hours (L 50 average life of 500,000 hours).
- 7 Drive Assembly** – Drives are sized for a minimum of 150% of driven horsepower. Machined cast iron pulleys are factory set to the required RPM and adjustable for final system balancing. Belts are static-free and oil resistant.
- 8 Fan Shaft** – Precisely sized, ground, and polished so the first critical speed is at least 25% over the maximum operating speed. Close tolerances, where the shaft makes contact with bearings, results in longer bearing life.
- 9 Disconnect Switch** – NEMA-1 disconnect switch is factory mounted and wiring is provided from the motor as standard. All wiring and electrical components comply with the National Electric Code and materials are UL Listed. Other NEMA enclosure disconnect switches are optional.

Access Panels (not shown) – The cabinet construction features two side access panels. Access panels permit easy access to all internal components.

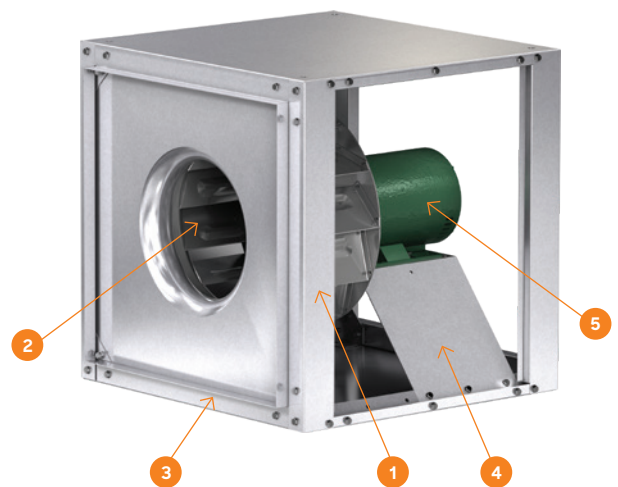
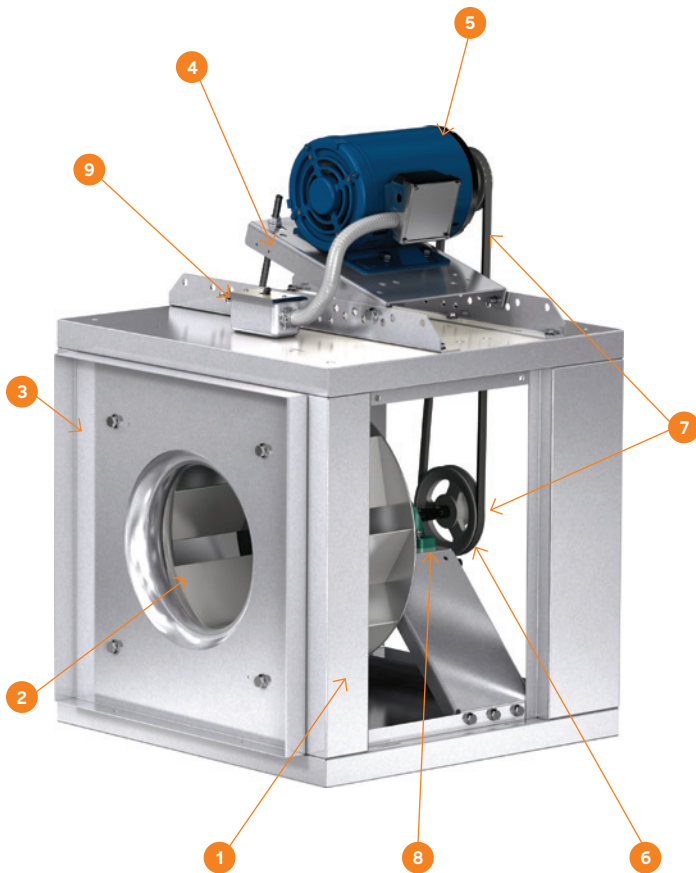

XQEI – Inline Fan

The XQEI inline fan has different wheel designs with different performance characteristics.

Class I wheels are optimized for performances involving low pressures and high volumes.

Class II wheels are designed for a steeper fan curve with high-pressure capabilities.

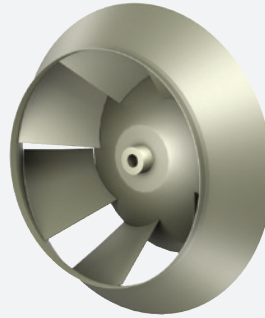

STANDARD CONSTRUCTION FEATURES

Cabinet Construction – Tubular housings are constructed of welded steel to eliminate air leakage. Integral straightening vanes are constructed from steel and welded into place.

Wheel – Mixed Flow – Fabricated wheels are constructed from steel. The blade profiles are angled and contoured for the most efficient and quiet performance.

Bearings – Standard bearings are premium air handling quality, grease lubricated, self-aligning, ball or roller type. Bearings are selected with a basic rating fatigue life L10 per ABMA standards, in excess of 80,000 hours (L50 at 400,000 hours) at the maximum operating speed for the QEI-I/II in the horizontal position.

Bolted Access Door – A bolted access door provides an opening through the fan housing for cleaning or visual inspection of the wheel. A hinged access door is available as an accessory.

Belt Guard – A totally enclosed belt guard provides protection from rotating pulleys and belts. Belt guards meet OSHA Standards.

Slip-Fit Duct Connection – Inlets and outlets are designed with extended collars for slip-fit duct connections as standard.

Adjustable Motor Bases – Rigid, heavy-gauge steel motor bases are welded to the fan housing and include heavy-duty adjustment screws for belt tensioning.

Extended Lube Lines – Units have nylon lubrication lines with grease fittings that allow bearing lubrication without disassembling the fan. Grease fittings are mounted on the outside of the fan housing. Smaller frame sized motors are typically sealed and not lubricatable.

Permatec™ Coating – A thermosetting polyester urethane electrostatically applied to provide uniform thickness and a clean appearance. Permatec™ coatings also provide excellent corrosion characteristics for general applications, both indoor and outdoor.

OPTIONAL CONSTRUCTION FEATURES

Type B or C Spark Resistance – Type B or C Spark Resistance – XQEI is available with spark resistant designs suitable for applications that involve flammable particles, fumes or vapors. Spark resistant construction options adhere to guidelines defined with AMCA Standard 99-0401-10.

Spark B Sizes 9 – 33 – The fan wheel is constructed of a non-ferrous material (aluminum). The aluminum bearing cover surrounds the driven bearing, shielding it from the airstream.

Spark C All Sizes – The inlet cone is constructed of non-ferrous material (aluminum). The aluminum bearing cover surrounds the driven bearing, shielding it from the airstream.

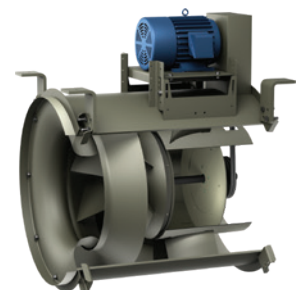

XTIF - Inline Fan

All XTIF inline fans are available in two levels of construction to provide the most efficient and economical selections. Construction differences between Level 1 and 2 selections include: the impeller, the inlet cone, the shaft size, and the bearings. The housings for both levels are identical in material gauge and overall design.

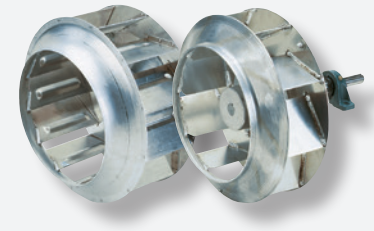

LEVEL 1 CONSTRUCTION

- Maximum pressure capabilities of 2 in. wg (500 Pa)
- Highest efficiencies at static pressures below 1.5 in. wg (375 Pa)
- Riveted, partially welded aluminum wheel construction
- Most economical selection

LEVEL 2 CONSTRUCTION

- Maximum pressure capabilities of 4 in. wg (993 Pa)
- Highest efficiencies at static pressures above 1.5 in. wg (375 Pa)
- Completely welded aluminum wheel
- Increased shaft and bearing diameter
- Increased horsepower and motor frame size capability

STANDARD CONSTRUCTION FEATURES

Inlet & Outlet Flanges – Flanged inlets and outlets with mounting holes are provided for duct connections.

Housing – Housings are continuously-welded steel and powder coated with Permator™.

Protective Coating – All steel constructed units are powder coated with Permator, a thermosetting polyester urethane. Aluminum units are uncoated.

Type B Spark Resistance – All fans have aluminum wheels and a non-ferrous (aluminum) rub ring, which surrounds the fan shaft where it passes through the drive cover. This construction meets Type B spark resistant requirements.

Bearings – Standard bearings are grease lubricated, self-aligning, ball type in pillow block mounts. Bearings are selected for a minimum L10 life in excess of 80,000 hours (L 50 average life of 400,000 hours) at maximum cataloged operating speeds.

Belt & Bearing Tube – Belts, bearings, and drives are protected from the airstream by heavy-gauge belt tubes and bolted bearing covers with shaft seals.

Extended Lube Lines – Lubrication lines with grease fittings allow bearing lubrication without disassembling the fan.

OPTIONAL CONSTRUCTION FEATURES

Type B or C Spark Resistance – Aluminum construction is available on the XTIF fans and is an excellent choice for applications involving moisture or coastal installations.

Easy Access Construction – The easy access option is highly recommended to allow for inspection, cleaning and service of internal fan components. By removing one access panel, service to the wheel, shaft, and bearing assembly is possible without removing duct connections. In addition, all internal fan components can be removed from the fan through the easy access panel.



Easy access construction is available on all levels and sizes of XTIF and is also available with aluminum construction fans.

UL 762 Restaurant Exhaust XTIF and XQEI

Inline grease exhaust fans are excellent alternatives for kitchen applications when roof or wall-mounted ventilators are not practical. The XTIF and XQEI with UL 762 grease option are designed to withstand the demands of high-temperature kitchen grease exhaust and high-pressure duct washes.

LEAK-RESISTANT CONSTRUCTION FEATURES

- Continuously welded housing and integral duct flanges, provide air and watertight design.
- Gasketed bearing cover, including a labyrinth shaft seal to prevent moisture leakage during normal operation, while cleaning with high-pressure solvents.
- Continuously welded belt tube keeps the belts and bearings clean.
- Threaded drain connections are located 90° from the motor location to allow for removal of grease and moisture.

MOUNTING AND SERVICEABILITY FEATURES

- Duct flanges and access door bolt locations are no more than 4 inches (100 mm) on center per NFPA 96.
- Easy access door provides access for duct cleaning, and allows removal of the wheel, shaft and bearings for maintenance. Gasket is rated for 400°F (204°C) and prevents leakage during operation. (XTIF only).

SYSTEM DESIGN GUIDELINES

- Inline grease exhaust fans should be installed near the end of the duct run to reduce sound at the hood.
- Inline fan must be securely bolted to the exhaust duct per NFPA 96 guidelines. Accurex's companion flanges are recommended for ease of installation.
- Grease exhaust fans and ductwork must maintain 18 inches (46 cm) minimum clearance to combustible material. If the ductwork and fan are insulated, the inspection door must be accessible for maintenance.
- A minimum of 10 ft. (3.0 m) of clearance must be kept from the fan outlet to adjacent buildings, property lines, or the closest point of any air intake or operable window at or below the plane of the exhaust termination.
- Accurex recommends that all inline grease applications be reviewed by your local code official to ensure compliance with NFPA, IMC and other local codes.
- Fan enclosure should have the same fire rating as the required fire rating on the connected duct enclosure.



- UL 762 is listed for grease applications
- Meets all UL 705 requirements
- Bolted access door
- Drain connection
- Meets requirements of NFPA 96 Ventilation Control and Fire Protection of Commercial Cooking Operations

XTIF

Listed Power Ventilation for Restaurant Exhaust Appliances
13G3 Maximum Operating Temperature
300°F (149°C).

XQEI

Listed Power Ventilation for Restaurant Exhaust Appliances
13G3 Maximum Operating Temperature
400°F (204°C).

Belt Guard – Belt guards are totally enclosed to provide protection from rotating pulleys and belts. Belt guards meet OSHA guidelines.

Motor Cover (Weatherhood) – Weatherproof motor covers shield the motor and drive components from dust, dirt and moisture when used in outdoor applications. Motor covers also provide protection from rotating pulleys and belts. The motor covers meet OSHA guidelines.

Inlet & Outlet Companion Flanges – Companion inlet flanges and outlet flanges with pre-punched holes are available for all fan sizes in painted steel construction.

Inlet & Outlet Guards – Removable inlet and outlet guards provide protection for personnel and equipment in non-ducted installations. These guards meet OSHA guidelines.

Inspection Door – Bolted or hinged doors provide access for cleaning or inspection.

Inspection Section – Inspection sections serve as a length of duct that can be easily removed to provide complete access to the fan for servicing. Each section includes a bolted inspection door.

Isolators – Both, base mount or hanging isolators, are available in either neoprene or spring mounts. The isolators are furnished in sets of four and sized to match the weight of each fan.

Mounting Rails – Mounting rails are required for horizontal mounting of XQEI and XTIF fans when the motor is to be located in the 3 or 9 o'clock position. Mounting rails are also recommended for all vertically mounted inline fans.

Aluminum Construction – Aluminum construction is available for direct drive sizes 60-160 and belt drive sizes 70-300.

Greenheck Vari-Green® Motor (VG) XID only – No shaft grounding required regardless of the turndown. Bearing life is greater since the motor runs cooler the further it is turned down. No voltage or current spikes as in VFD controlled motors.

Speed Controllers – Available for use with shaded pole and permanent split capacitor (PSC) open motors on model XID fans. They provide an economical means of system balancing with direct drive fans.

Greenheck Vari-Green® Controls – Electronic commutation uses electronic circuitry to control the motor's functions. Solid-state circuitry controls the output of power and the speed of rotation. Internal circuitry converts 115-volt single-phase AC power to DC voltage for increased efficiencies and full controllability of speed.

Direct Drive Motor Cover – Formed galvanized steel motor covers are available to isolate direct drive motors from the airstream. When motor covers are furnished, vents to the exterior of the fan are provided to ensure sufficient motor cooling.

Dampers – Motorized parallel blade dampers (Model WD-330) are available for duct mounting. These dampers feature sturdy galvanized frames with pre-punched mounting holes, aluminum blades with felt edges and a balanced design for minimal resistance to airflow.

Control Dampers – Square opposed blade volume control dampers (Model VCD) are available for duct mounting. These dampers (not available with UL/cUL 762) feature sturdy galvanized frames with pre-punched mounting holes, steel blades with vinyl seals and flexible metal jamb seals. A balanced design results in minimal resistance to airflow.

Coatings – Wide variety of coatings and colors are available. Decorative coatings are available in 16 different colors. Protective coatings are available in a choice of five electrostatic applied powders providing an available selection for most environments.

Wiring Pigtail – Allows direct hook-up to the power supply eliminating field wiring at the fan.

Pressure Probe – A 1/4-inch diameter tube in the fan venturi allows hook-up to the manometer for static pressure measurement.

Insulated Housing – For noise reduction and condensation control, the interior of the fan housing can be lined with a fiberglass duct liner (1/2 and 1 inch being standard). The optional motor cover can also be insulated.

The table below depicts the dB reduction that can be obtained in each octave band for the insulated housing and motor cover together.

Approximate dB Sound Attenuation								
Octave Band	1	2	3	4	5	6	7	8
Sizes 60 - 130	-2	-7	-4	-4	-6	-13	-13	-9
Sizes 140 - 420	-3	-2	-5	-4	-5	-5	-7	-8

ELECTRICAL ACCESSORIES

Toggle type and heavy-duty disconnect switches are available for positive electrical shut off and safety in servicing fans.

Enclosure	Application	Toggle	Heavy-Duty
NEMA-1	Indoor, General Purpose	Yes	Yes
NEMA-12	Indoor, Dust/Drip Tight	Yes	Yes
NEMA-3R	Indoor/Outdoor, Rainproof	Yes	Yes
NEMA-4	Indoor/Outdoor, Watertight	Yes	Yes
NEMA-4X	Indoor/Outdoor, Watertight (Corrosion-Resistant)	Yes	Yes
NEMA-7 & 9	Indoor/Outdoor, Hazardous Locations	Yes	No

SIDE DISCHARGE OPTION

The side discharge option provides several advantages, from removing a system effect problem, increasing performance, or even reducing installation labor. The most notable is reducing system effects. In Fig. 1, notice how the air, when discharged into the corner, will take several duct lengths before becoming smooth again. This is not the case with a side discharge. Notice now in Fig. 2 as air comes into the fan/corner and leaves the fan/corner, you have nice smooth airflow providing a more predictable system. Duct length prior to or following the installation location should be approximately two to three wheel diameters to achieve cataloged performance.

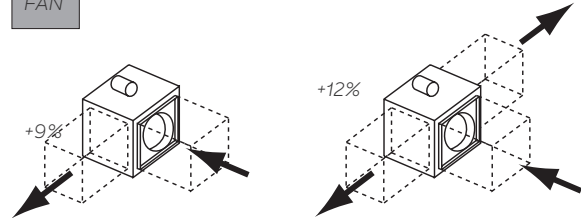
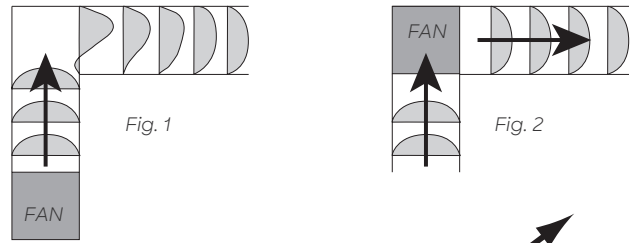

DISCHARGE CONFIGURATION

Make sure discharge is oriented in the same direction as originally ordered, as performance will change with different discharge positions. Right side discharge will give you 108% of cataloged performance and the left side will give you 109% of cataloged performance. Refer to Fig. 3 to locate an orientation that fits your application and Fig. 4 and 5 for proper side discharge definition. Consult your local rep for performance modifications.

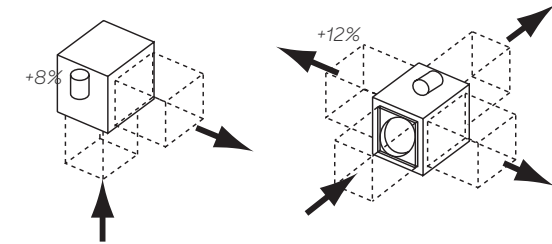

Fig. 3

Percentages based on cataloged performance.

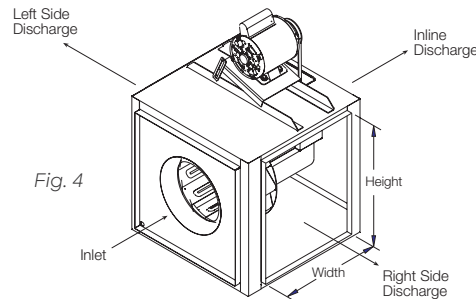
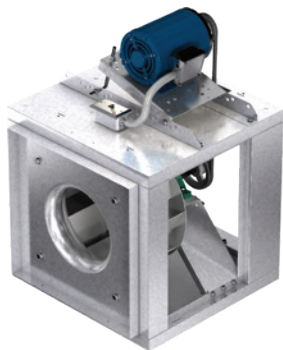

Fig. 4

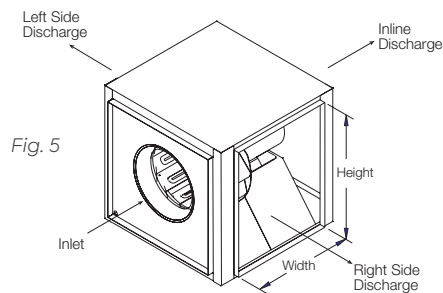
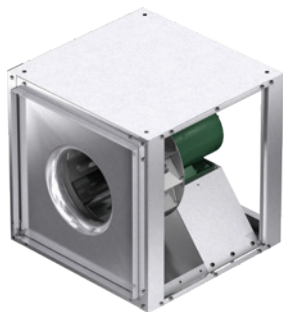

Fig. 5

XIB SIDE DISCHARGE DUCT OPENINGS

Unit Size	Width	Height
70, 80, 90, 100	12½	13%
120	12½	15%
130, 130HP	12½	17%
140, 140HP	13½	19%
160, 160HP	17½	22%
180, 180HP	19½	23%
200, 200HP	23½	27%
240, 240HP	25½	34%
300, 300HP	31%	41%
360, 360HP	32%	37%
420	34%	43%

XID SIDE DISCHARGE DUCT OPENINGS

Unit Size	Width	Height
60, 70	9%	8%
80, 90, 95	12%	11%
97, 98, 99	13%	11%
100	13%	13%
120	15%	15%
130, 130HP	17%	17%
140, 140HP	19%	19%
160, 160HP	22%	22%

FILTER BOXES

The filter box is designed to provide a compact, convenient, and clean air solution. Factory-assembled as a single unit, this fan eliminates the costly process of designing, fabricating and installing special remote filter box assemblies. Both, the fan and filter section, feature removable access panels on both sides to remove and replace filters, making fan maintenance simple and fast.

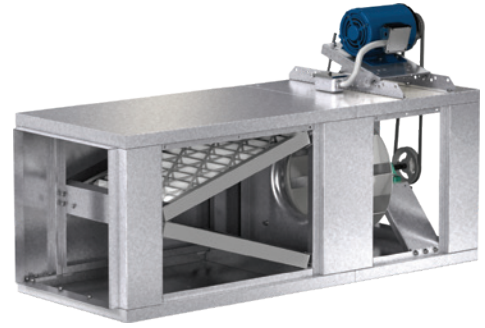

MODEL XIB

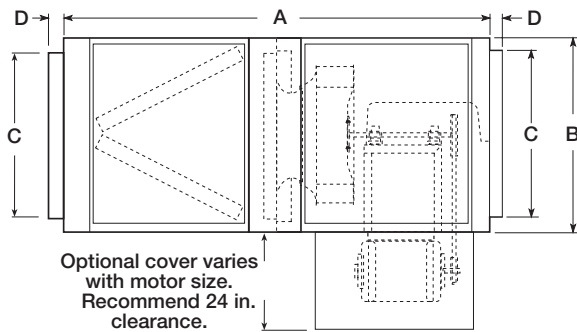

MODEL XID

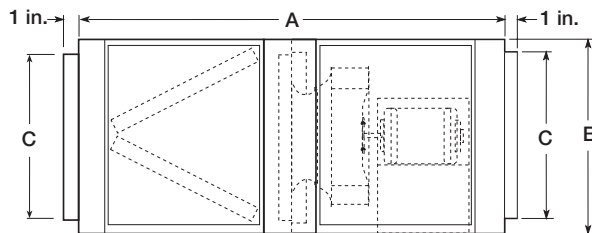

MODEL SELECTION PROCEDURE

1. Calculate system pressure drop and CFM requirements. (Not including filters).
2. Make a preliminary model size selection.
3. Calculate a filter pressure drop for the preliminary model size selected in step 2 using the equation:

$$P = F \times \left(\frac{\text{cfm}}{10,000} \right)^2$$

4. Add the filter pressure drop (P) to the system pressure drop and make a revised model size selection. Use the chart to the right to determine filter factor (F).

Unit Size	A	B	C	D	WT.	Filter Size	Qty.
70, 80, 90	53 ⁵ / ₇	17 ¹ / ₂	11 ¹ / ₂	1 ¹ / ₂	168	16 x 20	2
100	53 ⁵ / ₇	17 ¹ / ₂	13 ¹ / ₂	1 ¹ / ₂	169	16 x 20	2
120	58 ³ / ₄	19 ¹ / ₂	15 ¹ / ₂	1 ¹ / ₂	194	16 x 25	2
130, 130HP	53 ¹ / ₄	21 ¹ / ₂	17 ¹ / ₂	1 ¹ / ₂	197	20 x 20	2
140, 140HP	59	23 ¹ / ₂	19 ¹ / ₂	1 ¹ / ₂	231	20 x 25	2
160, 160HP	58 ³ / ₄	26 ¹ / ₂	22 ¹ / ₂	1 ¹ / ₂	285	20 x 20	4
180, 180HP	60 ³ / ₄	27 ¹ / ₂	23 ¹ / ₂	1 ¹ / ₂	293	20 x 25	4
200, 200HP	69 ³ / ₈	31 ¹ / ₂	27 ¹ / ₂	1 ¹ / ₂	361	12 x 25	3
						16 x 25	3
						20 x 25	4
240, 240HP	71 ¹ / ₂	38 ¹ / ₂	34 ¹ / ₂	1 ¹ / ₂	496	16 x 25	4
300, 300HP	72 ¹ / ₂	46	41 ¹ / ₂	1 ¹ / ₂	759	20 x 25	8
360, 360HP	94 ¹ / ₄	52	47 ¹ / ₂	1 ¹ / ₂	957	16 x 25	10
						20 x 25	5
420	93 ¹ / ₂	58	53 ¹ / ₂	1 ¹ / ₂	1185	16 x 25	5
						20 x 25	10

Note: 24 inch side clearance is recommended for accessing and removing filters. All dimensions in inches and weight in pounds.

Unit Size	A	B	C	WT.	Filter Size	Qty.
60, 65, 70, 75	22 ¹ / ₂	12	8 ³ / ₈	40	10 x 20	1
80, 85, 90, 95	45 ¹ / ₂	15	11 ¹ / ₂	74	14 x 25	1
97, 98, 90	50 ¹ / ₂	15	11 ¹ / ₂	80	14 x 25	1
100	74 ¹ / ₄	17	13 ¹ / ₂	88	16 x 20	2
120	52 ³ / ₈	19	15 ¹ / ₂	114	16 x 25	2
130, 130HP	46 ³ / ₈	21	17 ¹ / ₂	120	20 x 20	2
140, 140HP	52 ³ / ₈	23	19 ¹ / ₂	174	20 x 25	2
160, 160HP	51 ¹ / ₂	26	22 ¹ / ₂	246	20 x 20	4

Note: 24 inch side clearance is recommended for accessing and removing filters. All dimensions in inches and weight shown is standard galvanized construction and largest cataloged open drip proof motor.

Model		1 in. Aluminum Filter Factor(F)	1 in. Paper Filters	2 in. Aluminum Filters	2 in. Paper Filters
XIB	XID				
-	60, 70	186	318.06	251.10	303.18
70, 80, 90	80, 90, 95	21.8	37.28	29.43	35.53
-	97, 98, 99	8.72	14.9112	11.772	14.2136
100	100	8.72	14.91	11.77	14.21
120	120	5.58	9.54	7.53	9.10
140	140	3.57	6.11	4.82	5.82
160	160	2.09	3.57	2.82	3.41
180	-	1.34	2.29	1.81	2.18
200	-	0.77	1.32	1.04	1.26
240	-	0.41	0.70	0.55	0.67
300	-	0.33	0.56	0.45	0.54
360	-	0.15	0.26	0.20	0.25
420	-	0.13	0.2	0.18	0.21

Note: Table is valid for HP models also.

ISOLATORS

Complete isolator kits are available with either neoprene or spring isolators and are sized to match the weight of the individual fan sizes.

The hanging isolator support brackets are designed to permit mounting the fan with the motor located on the top, bottom or side (hanging rods supplied by others). The base isolator support brackets are designed to permit mounting of the fan with the motor located on top or either side.

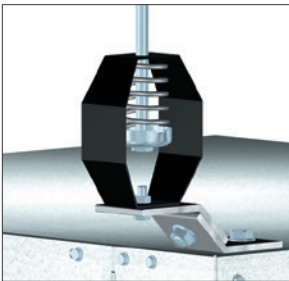

**HANGING
SPRING
ISOLATOR**

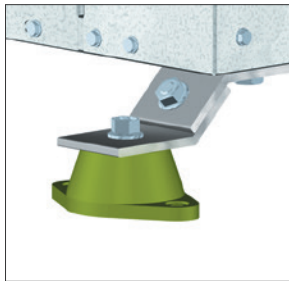

**STANDING
NEOPRENE
ISOLATOR**

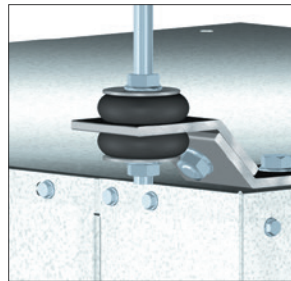

**HANGING
NEOPRENE
ISOLATOR**

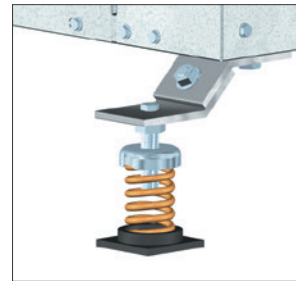

**STANDING
SPRING
ISOLATOR**

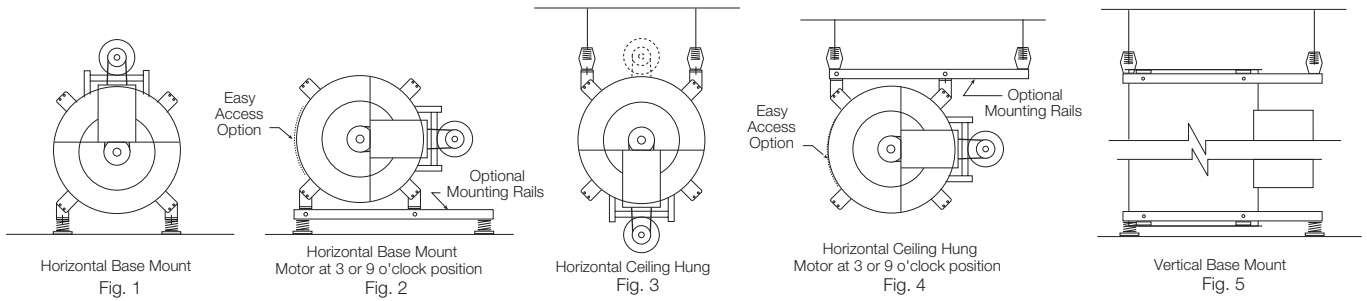

UNIVERSAL MOUNTING

All XQEI and XTIF fans can be mounted horizontally or vertically. For ease of installation, eight mounting brackets are welded on each fan. The eight brackets along with four mounting supports, provide a universal mounting system.

Fig. 1 Horizontal Base Mount

Each fan is shipped as standard in this arrangement. Motor at 12 o'clock is standard.

Fig. 2 Horizontal Base Mount with Motor at 3 or 9 o'clock

A set of optional mounting rails are required for this installation. This is the base mounting position required with the easy access option.

Fig. 3 Horizontal Ceiling Hung

In this installation, the supports can be positioned for mounting the motor at either 6 or 12 o'clock.

Fig. 4 Horizontal Ceiling Hung with Motor at 3 or 9 o'clock

A set of optional mounting rails are required for this installation.

Fig. 5 Vertical Mount

All XQEI and XTIF fans can be mounted vertically (ceiling hung or base mounted) for either upward or downward airflow. Optional mounting rails are recommended.

Note: All fans are shown with optional vibration isolators. Contact your local Accurex representative for complete dimensional data.

OPTIONS AND ACCESSORIES	XIB	XID	XQEI	XTIF
Belt Guard	-	-	Optional	Optional
Motor Cover (Weatherhood)	Optional	Optional	Optional	Optional
Inlet and Outlet Companion Flanges	Optional	Optional	Optional	Optional
Inlet and Outlet Guards	Optional	Optional	Optional	Optional
Inspection Door	-	-	Standard	Optional
Inspection Section	-	-	-	Optional
Isolators	Optional	Optional	Optional	Optional
Mounting Rails	Standard	Standard	Optional	Optional
Inlet Vane Dampers	Optional	Optional	-	-
Aluminum Construction	Optional	Optional	-	Optional
Speed Controllers	-	Optional	-	-
Gravity Dampers	Optional	Optional	-	-
Control Dampers	Optional	Optional	-	-
Coatings	Optional	Optional	Standard	Standard
Wiring Pigtail	Optional	Optional	-	-
Insulated Housing	Optional	Optional	-	-
Drain Connection	-	-	Standard	Standard
Nema Disconnect	1	1	3R, 4, 4X, 12	3R, 4, 4X, 12
Greenheck Vari-Green® Motor	-	Optional	-	-
Greenheck Vari-Green® Controls	-	Optional	-	-
Seismic Rated	Optional	Optional	-	-



Utility Fans

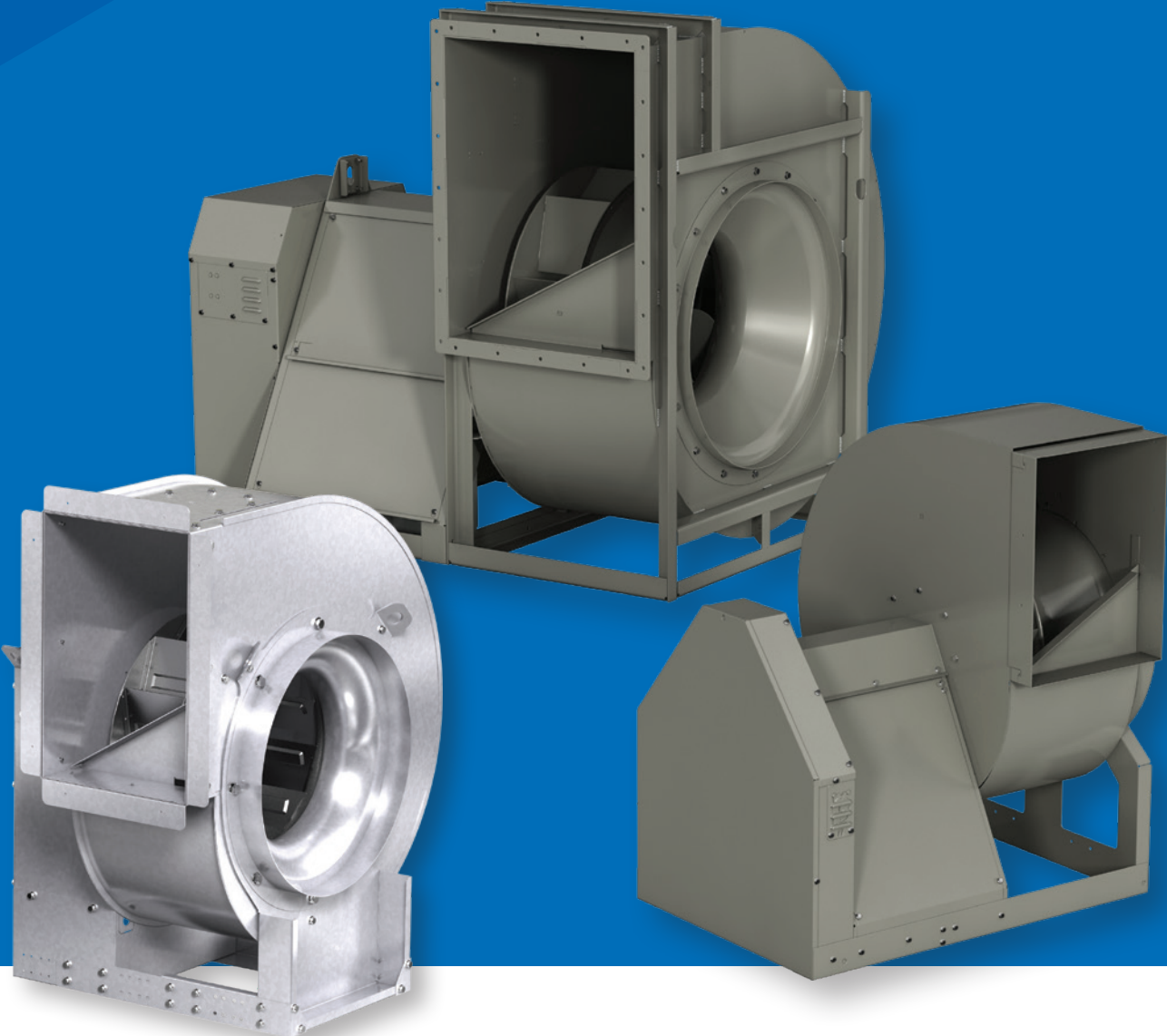

Restaurant Grease Exhaust (UL/cUL 762 Listed)

RESTAURANTS

The centrifugal scroll fans are designed for high-pressure restaurant grease exhaust applications. Either Permalock™ or welded housings are available with UL/cUL Listing of Power Ventilators for Restaurant Exhaust Appliances. The welded housing is suitable for indoor or outdoor mounting locations, whereas the Permalock™ housing is suitable for outdoor kitchen ventilation installations. Listing tests exceed duct temperatures of 400°F (204°C) continuous operation. UL/cUL 762 selections require a drain connection and access door for cleaning.

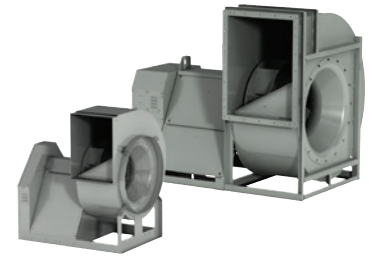

Models: XUEF-300,
XUEF-500

Light Duty Commercial and Institutional

GENERAL VENTILATION, OFFICE SPACE, RETAIL SPACE, CAFETERIAS, BREAK ROOMS, CONFERENCE ROOMS

Buildings or rooms with relatively clean air found in a normal workplace environment. Air volumes are typically below 8,000 cfm with static pressures less than 3 in. wg (747 Pa). The application needs a basic fan model providing good value. Galvanized housing and bolted construction are appropriate for the requirements of this application.

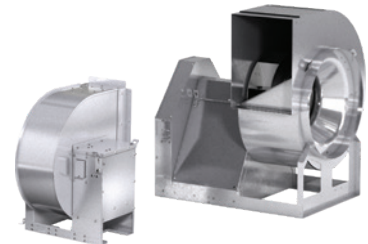

Models: XUEF-100,
XUEF-300

Commercial and Institutional

WAREHOUSE, HOTELS, ATRIUMS, THEATERS, GYMS, LIBRARIES

Larger volumes of air to 20,000 cfm with low to moderate static pressures to 5 in. wg (1,245 Pa). Air quality is relatively clean; used for supply or exhaust. Fan coating available for cosmetic appearance or improved weather protection. Instances may require fan certified for use in emergency conditions.

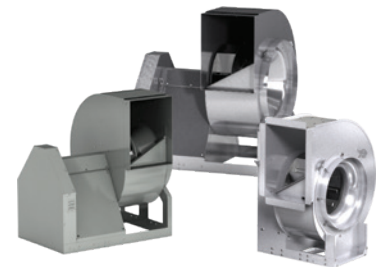

Models: XUEF-100,
XUEF-300

Light Industrial and Specialty Commercial

WASTEWATER TREATMENT, GARAGE EXHAUST, RESTAURANTS, MECHANICAL ROOMS, MANUFACTURING SPACE, DEDICATED EXHAUST HOODS, EMERGENCY SMOKE, NATATORIUMS, CLEANROOMS

Category involves a wide range of airflow volume from very low to 60,000 cfm with moderate pressures below 8 in. wg (1,990 Pa). Fans applied to dedicated exhaust systems or combined between process and clean air. Fans may be subjected to increased levels of chemicals or particulates in the air. Additional contaminants such as grease exhaust or light dust are possible. Specialized coatings are available when needed. Fans may also have need for dual use in emergency conditions or spark resistance.

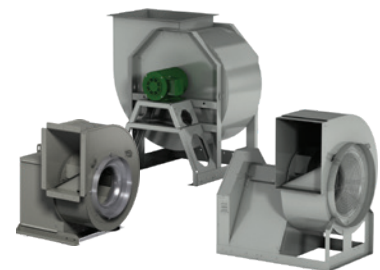

Models: XUEF-100,
XUEF-300, XUEF-500

XUEF

- Backward-inclined utility fans
- Housing and blower scroll options of galvanized, painted steel or aluminum
- Belt and direct drive
- Wheel made of aluminum or steel
- Greenheck Vari-Green® EC motor and AC induction motor w/ microdrive offered on direct drive models
- Available in sizes, 4 through 73, with capacities up to 230,000 cfm (390,772 m3/hr) and static pressures to 21 in. wg (5230 Pa)

MODEL OVERVIEW
 Provides higher operating efficiencies, non-overloading horsepower curves and higher pressure capabilities.

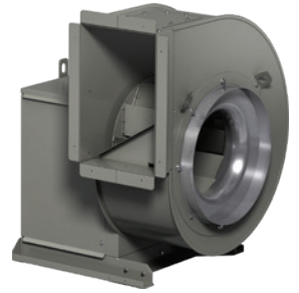

XUEF OPTIONAL DISCHARGE POSITIONS

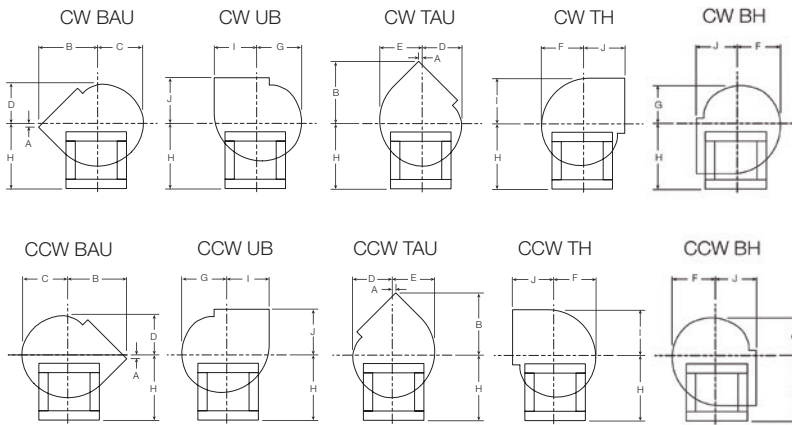

XUEF-100 = TH, UB
 XUEF-300 and XUEF-500 = TH, UB, BH, TAU, BAU

CW BH and CCW BH is not available with UL/cUL 762

XUEF-100

The XUEF-100 is constructed from galvanized steel with a bolted frame. It provides an economical price point option for applications for when clean air is being exhausted. The XUEF-100 is available in both direct and belt drive configurations. Direct drive models feature either Vari-Green EC motor or AC induction motor with microdrive and are mounted, wired, and programmed right at the factory.

- Up to 14,000 cfm
- Up to 3 in. wg
- Certifications:
 - AMCA licensed for Air (AMCA 210)
 - UL/cUL 705 Listed for Electrical

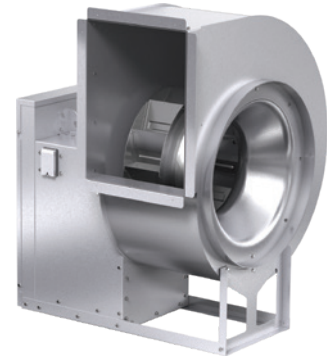

XUEF-300

The XUEF-300 is a workhorse product used in general applications for commercial to light industrial installations. It is available in both galvanized and coated steel configurations. This arrangement 10, belt drive solution offers a slew of different options at a value. It offers the flexibility of bolted or welded construction and an increased performance range for Class I airflow and pressures.

- 200 up to 53,000 cfm
- Up to 5.5 in. wg
- Spark B or C resistant construction available
- Certifications:
 - AMCA licensed for Air (AMCA 210) sizes 6 - 10, 27 - 49
 - AMCA licensed for Sound and Air (AMCA 210 and 300) sizes 12 - 24
 - UL/cUL 705 Listed for Electrical
 - UL/cUL 762 Listed for Grease Exhaust
 - UL/cUL Listed for Power Ventilators for Smoke Control

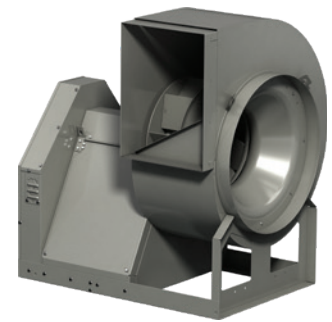

XUEF-500

The XUEF-500 spans the gap between traditional utility sets and industrial blowers. It is constructed of painted steel construction and is capable of up to Class IV applications and utilizes a backward inclined wheel.

- Up to 230,000 cfm
- Up to 21 in. wg
- Spark A, B, or C resistant construction available
- Certifications:
 - AMCA licensed for Sound and Air (AMCA 210 and 300)
 - UL/cUL 705 Listed for Electrical
 - UL/cUL 762 Listed for Grease Exhaust
 - UL/cUL Listed for Power Ventilators for Smoke Control

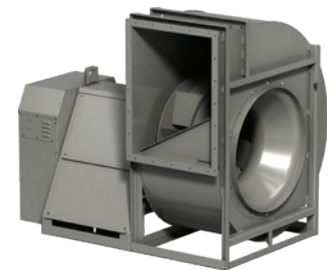

XUEF-100

- Scroll is galvanized non-painted construction
- Housing is heavy-gauge steel, Permalock™
- Used for inexpensive clean air applications



XUEF-300

- Bolted construction, utilizing galvanized or painted steel material
- Used for grease, smoke and clean air applications

XUEF-500

- Welded construction, utilizing all painted steel material
- Used for grease, smoke and clean air applications
- Heavier construction and capable of higher performances than XUEF-300

**XUEF-100, XUEF-300 & XUEF-500
STANDARD CONSTRUCTION FEATURES**

Scroll Construction – Permalock™ housings use a mechanically fastened seam instead of welding. This airtight and watertight housing construction uses the same structural support as all welded housings.

Wheel Type, Material and Construction

XUEF-100:

Type: Backward-inclined

Material: Size 4-24 aluminum

Construction: Riveted or robot welded

XUEF-300:

Type: Backward-inclined

Material: Size 6-10 aluminum / Size 12-49 coated steel

Construction: Size 6-24 riveted / Size 27-49 welded

XUEF-500:

Type: Backward-inclined

Material: Coated steel

Construction: Welded

Fasteners – Corrosion-resistant fasteners are used to secure unit base and blower scroll assembly.

Bearings – Heavy-duty, self-aligning pillow block ball bearings are selected for a minimum L10 life in excess of 80,000 hours (L50 average life of 400,000 hours) at maximum cataloged operating conditions.

Motor – Heavy-duty ball bearing motors are carefully matched to the fan load. Open drip proof, totally enclosed and explosion-proof enclosures are available.

Weatherhood and Motor Cover – Vented steel weatherhoods and a motor cover protect the drive components from rain, moisture, dust and dirt. Weatherhoods meet OSHA guidelines and are easily removed for service access.

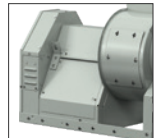

Drive Assembly – Machined, cast iron pulleys are factory set to required RPM and are adjustable for final system balancing for applications with 10 hp or less motors. Sized for a minimum of 150% of driven horsepower.

Inlet Cone – Streamlined inlet cone design provides a low turbulence air intake. This reduces intake losses and sound levels.

Permactector™ – Permactector™ is our standard coating, typically used for applications that require corrosion resistance in indoor and outdoor environments. *Models: XUEF-300, XUEF-500*

XUEF Direct Drive

The XUEF direct drive model (100 series only) is an arrangement for utility set fan with a backward-inclined centrifugal wheel. The housing is constructed from galvanized steel with a bolted frame. High-performance powder coating is optional. Fans are provided with integral speed control for easy system balancing. Simplified wiring and preprogrammed variable frequency drive (3-phase) make installation quick and easy.

STANDARD CONSTRUCTION AND CONFIGURATION

- Volume up to 6,500 cfm
- Static pressure up to 3 in. wg
- Galvanized or coated steel
- Permalock™ lock seam scroll
- Aluminum wheel
- NEMA-3R, toggle switch, mounted and wired
- Bolted access door
- Weatherhood
- Drain

GREENHECK VARI-GREEN® MOTOR BENEFITS

Electronically commutated (EC) Vari-Green motor combines motor technology, controllability and energy-efficiency into a single low-maintenance unit and is the industry's first fully-controllable motor.

- Motor can attain up to 85% efficiency, reducing energy consumption
- 80% usable RPM turndown vs. 30% on AC single phase direct drive, allowing for a broader speed adjustment covering more fan performance ranges

3-PHASE MOTOR WITH MICRO DRIVE (VFD)

EC motors are great for single-phase applications. However, once fan performance approaches 1 hp, motors move to 3-phase applications. Using a 3-phase induction motor with a micro drive (VFD) is a good way to get the same functionality as an EC motor.

- 3-phase induction motors are just as or more efficient than single-phase EC motors
- VFD allows motor to speed up or slow down to achieve desired RPM

ACCESSORIES

- Inlet guard
- Outlet flange
- Outlet guard
- Backdraft gravity damper
- Neoprene isolators
- Equipment supports
- Extended warranty

- 1 Simplified Wiring** – Easy to install – featuring a terminal strip, disconnect and speed control mounted and wired by the factory.
- 2 Direct Drive Motor** – Low maintenance – no belts, bearings or pulleys to service.
- 3 Integrated Speed Control** – Speed control is mounted, wired and programmed at the factory. Adjust fan speed with the push of a button. Single-phase applications use electronically commutated (EC) Vari-Green motor with a control dial for adjustment. Three-phase applications use a NEMA Premium Efficient motor with variable frequency drive (VFD). 1- and 3-phase options can be controlled via 0-10 vDC signals.



UL/cUL 762 – The UL/cUL 762 option includes a weatherhood, threaded drain connection and access door. Indoor mounting requires the fan to have welded scroll construction.

UL/cUL 705 – Listed for electrical safety.

Weatherhood – Weatherhoods completely cover the motor and drive compartments to protect the shaft, bearings, motor, and drive components from moisture and other adverse conditions. Weatherhoods are vented to provide sufficient motor cooling and are designed to meet OSHA guidelines.

Drain Connection – Drain connections can be provided to drain moisture from the bottom of the fan housing.

Access Doors – Access doors provide access for inspection and cleaning. Either bolted or hinged quick-opening access doors are available.

Welded Scroll Construction – Welded scroll construction is available to provide a liquid tight seal.

Equipment Supports – Models GESI, GESS, and GESR

equipment supports are available for roof mounting of utility fans. Equipment supports are available in a number of lengths, widths and heights, and can also be built for a pitched roof.



Extended Lube Lines – Lubrication lines with grease fittings are extended from shaft bearings to the base of the drive frame panel or weatherhood for easy bearing lubrication without disassembling the fan.

Inlet & Outlet Guards – Inlet and outlet guards are constructed of expanded metal and mounted in a steel frame to provide protection for non-ducted installations. The guards can be easily removed for maintenance or inspection.



Coatings – Fans are available with a wide selection of protective and decorative coatings.

Grease Trap with Drain Connection – Trap is designed to collect grease residue and avoid drainage onto the roof surface. Disposable grease absorbents are available for easy maintenance.

Vibration Isolators – Neoprene or spring isolators are available to lessen mechanical vibration and assure quiet operation. Isolators are sized to match the weight of each fan.



Flanged Inlet & Outlet – Flanges are available for damper mounting or flanged duct connections. Inlet flanges have pre-punched mounting holes. Outlet flanges are bolted-on as standard but are welded for UL 762 applications.

Heat Slinger & Shaft Seal – The heat slinger is an aluminum cooling disc mounted on the fan shaft between the inboard bearing and the fan housing. The disc dissipates heat that is conducted along the fan shaft. The shaft seal with an aluminum rub ring is available for applications where contaminated or high-temperature air is being handled.

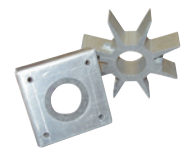

Dampers – Gravity or motorized backdraft dampers can be provided. These dampers feature sturdy galvanized frames with pre-punched mounting holes, aluminum blades and a balanced design for minimal resistance to airflow. Backdraft dampers are not suitable for downblast or bottom angular downblast discharge positions. To install a backdraft damper directly to the fan, the fan must be supplied with a flanged outlet. Heavy-duty dampers are available for high-pressure applications on fans with motors equal to or greater than 7½ horsepower.

Disconnect Switches – Assorted NEMA rated disconnect switches are available for positive electrical shutoff and safety when servicing fans. Factory mounting and wiring is available for added convenience.



Mounting Options

DIRECT MOUNT

No base required. Isolators are attached directly to equipment. Direct isolation can be used if equipment is unitary and rigid without the use of additional support. If there is any doubt whether or not equipment can be supported directly on isolators, use rails or consult the factory.

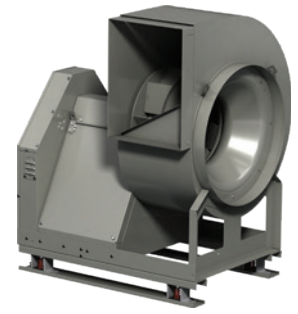

Isolators

NEOPRENE MOUNTS

Neoprene mountings consist of a steel top plate and base plate completely embedded in colored (oil-resistant) neoprene for easy identification of capacity. Neoprene mountings are furnished with a tapped hole in the center. This enables the equipment to be bolted securely to the rubber mount.

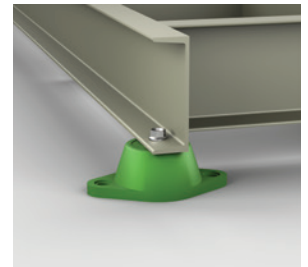

RESTRAINED SPRING MOUNTS

Restrained spring isolators consist of laterally stable, free-standing springs assembled into a steel housing. These assemblies are designed for vertical and horizontal motion restraint. Restrained spring isolators can be used for blocking during equipment installation and are provided with leveling bolts. Springs provide 50% overload capacity and are color-coded or identified to indicate load capacity. Restrained spring mounts are recommended for equipment subject to wind loading or large torquing forces.

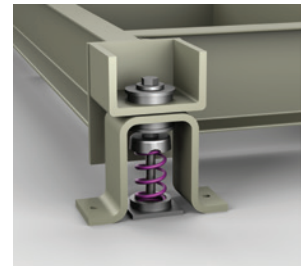

FREE-STANDING OPEN SPRING MOUNTS

Free-standing spring isolators are unhoused laterally stable steel springs. They provide a minimum horizontal stiffness of 0.8 times the rated vertical stiffness and provide an additional 50% overload capacity. These isolators are equipped with a top-mounted adjusting bolt and an acoustical non-skid base. Springs are color-coded or identified to indicate load capacity.



Model XUEF is designed for your supply, exhaust and return air applications. Tests were conducted to assure safe, rugged and reliable fans, capable of withstanding severe conditions. Due to the varying airstreams encountered in commercial ventilation systems, designers must be aware of national, state, and local codes and guidelines governing these installations.

TYPICAL INSTALLATION - GENERAL CLEAN AIR OR FUME HOOD (NON-GREASE)

Accurex’s utility fans are designed for applications ranging from clean air to contaminated air. Typical installations for XUEF’s are shown below.

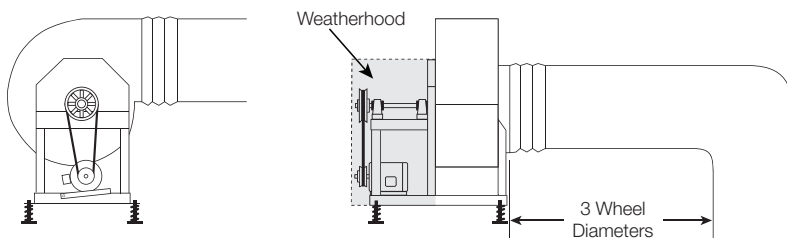

TYPICAL INSTALLATION - COMMERCIAL KITCHEN (GREASE)

Installation must include a means for inspecting, cleaning and servicing the exhaust fan.

- Fans selected for grease removal must include a weatherhood, bolted or hinged access door, and a 1 inch (25 mm) drain connection
- For grease applications where the fan is mounted indoors, the welded scroll option must be selected
- An outlet guard is strongly recommended when the fan discharge is accessible
- An upblast discharge is recommended
- The fan must discharge a minimum of 40 inches (1016 mm) above the roofline and the exhaust duct must be fully welded to a distance of 18 inches (457 mm) above the roof surface
- No dampers are to be used in the system

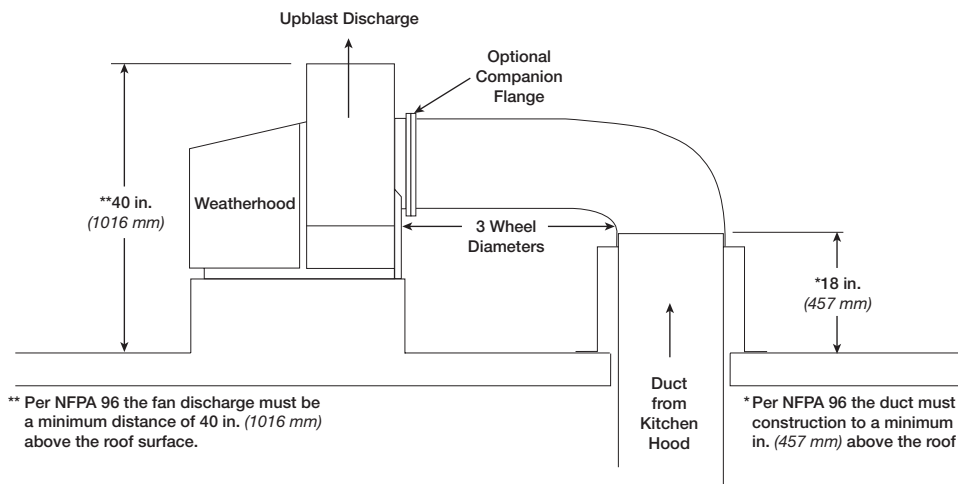

** Per NFPA 96 the fan discharge must be a minimum distance of 40 in. (1016 mm) above the roof surface.

* Per NFPA 96 the duct must be all welded construction to a minimum distance of 18 in. (457 mm) above the roof surface.



XUEF-300, -500 models are listed for grease removal (UL/cUL 762) File no. MH11745.

OPTIONS AND ACCESSORIES	XUEF-100	XUEF-300	XUEF-500
UL/cUL 762	-	Optional	Optional
UL/cUL 705	Optional	Optional	Optional
Weatherhood	Standard	Standard	Standard
Drain Connection	Standard	Optional	Optional
Access Doors	Standard	Optional	Optional
Welded Scroll Construction	-	-	Optional
Equipment Supports	Optional	Optional	Optional
Extended Lube Lines	Standard	Optional	Optional
Inlet and Outlet Guards	Optional	Optional	Optional
Coatings	-	Optional	Standard
Grease Trap with Drain Connection	-	Optional	Optional
Vibration Isolators	Optional	Optional	Optional
Flanged Inlet and Outlet	Optional	Optional	Optional
Heat Slinger and Shaft Seal	-	Optional	Optional
Dampers	Optional	Optional	Optional
Disconnect Switches	Standard	Optional	Optional



Roof Exhaust

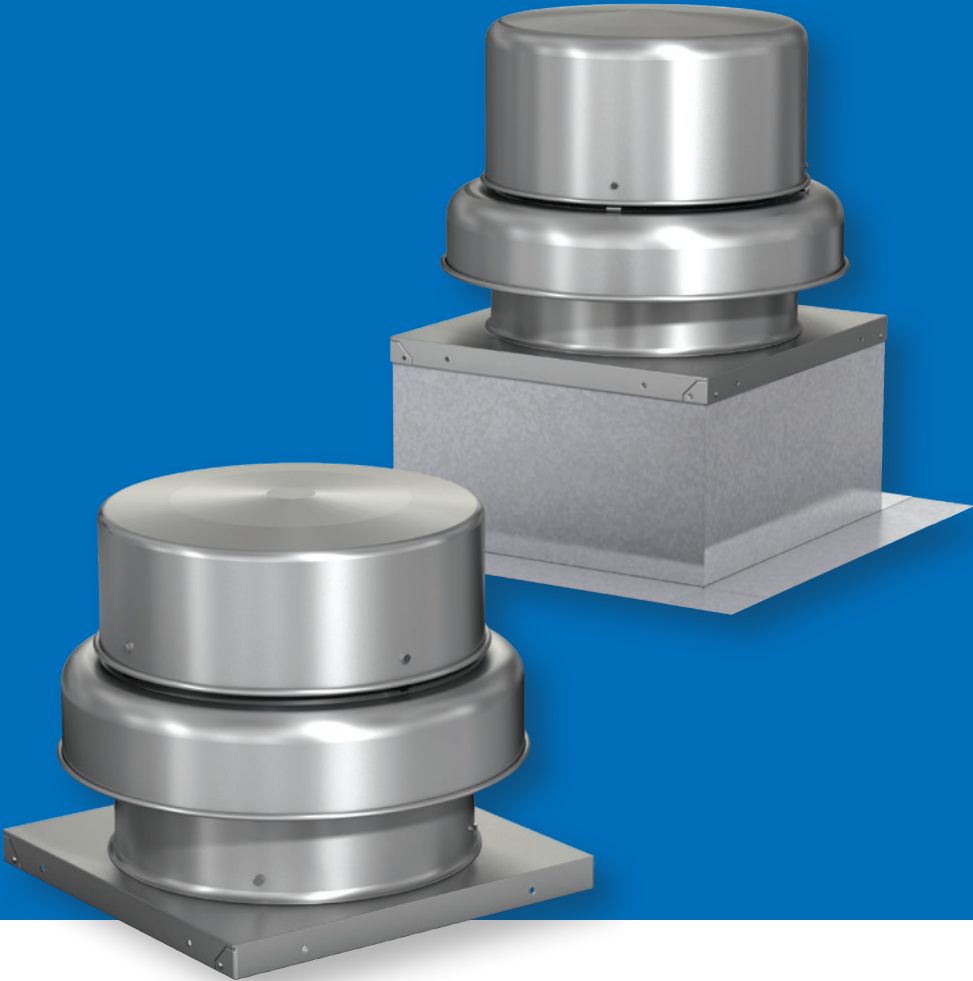

At Accurex, we put our products through extensive life testing, assuring you that the fans will provide years of reliable performance. All fan sizes are tested in our AMCA accredited laboratory, and all models are licensed to bear the AMCA Sound and Air Performance seal. You will also receive the following benefits with an Accurex centrifugal roof exhaust fan:

MODEL OVERVIEW
Accurex's centrifugal roof exhaust fans provide the industry's best performance and durability for general clean air applications.

- Broadest performance in the industry, up to 3.25 in. wg (810 Pa) and 44,700 cfm (75,950 m3/hr)
- Most advanced motor cooling of any fan in its class
- Seismic Certification IBC 2015. OHSPD/OSP Certification
- Certified to High Wind and Hurricane standards. NOA and FLPA Certified

MODEL NUMBER CODE: The Model Number Code is designed to completely identify the fan. The correct code letters must be specified to designate belt or direct drive. The remainder of the model number is determined by the size and performance.

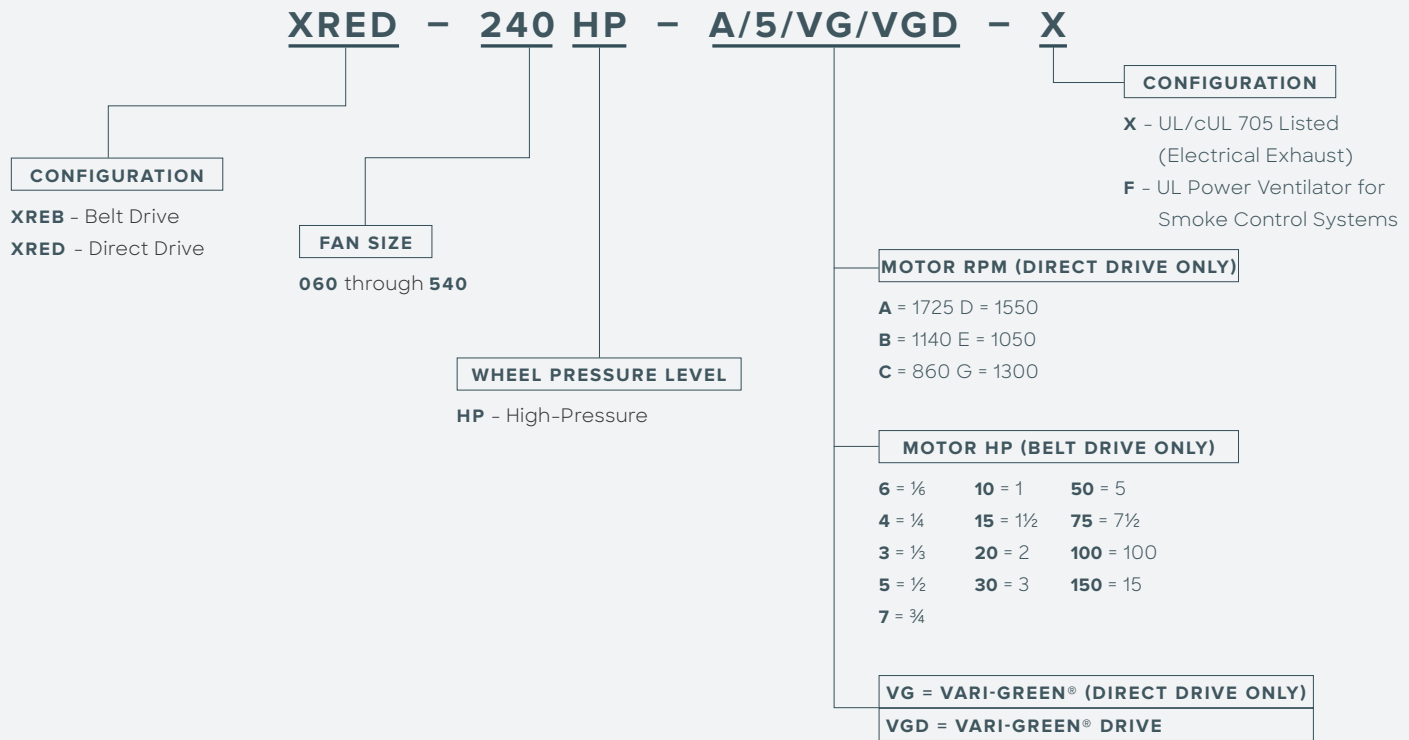

XRED - Direct Drive

Model XRED direct drive centrifugal fans are specifically designed for general clean air, roof mounted applications. Ideal for use with average duct runs and average-resistance duct, the XRED provides long service with little maintenance. Performance ranges up to 14,500 cfm and 2.75 in. w.g (24,636 m³/hr) with a maximum operating temperature of 180°F (82°C). Seismic certification to size 200. High wind certification to size 200.

XREB - Belt Drive

Model XREB belt drive centrifugal fans are specifically designed for general clean air, roof mounted applications. Ideal for use with average length duct runs and average-resistance duct the XREB provides performance flexibility ranging up to 44,700 cfm (75,946 m³/hr) and 3.5 in. wg (547 Pa). The maximum operating temperature is 180°F (82°C). Seismic certification to size 540. High wind certification to size 300.

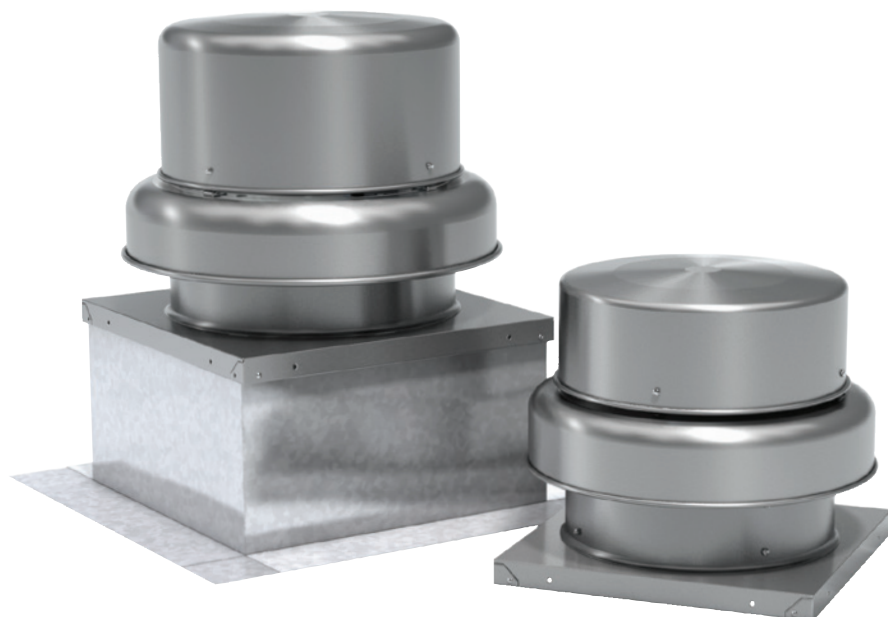

STANDARD CONSTRUCTION FEATURES XRED AND XREB

- 1 **Wheel** – Backward-inclined, non-overloading centrifugal wheel is utilized to generate high efficiency and minimal sound. Wheel cones are carefully matched to the venturi for maximum efficiency. Each wheel is statically and dynamically balanced for long life and quiet operation.
- 2 **Disconnect Switch** – NEMA-1 switch is factory mounted and wiring is provided from the motor as standard (other switches are available). All wiring and electrical components comply with the National Electrical Codes (NEC) and are either UL/cUL Listed or Recognized.
- 3 **Internal Conduit Chase** – A large diameter conduit for installing electrical wiring through the curb cap into the motor compartment.
- 4 **Fan Shaft** – Precisely sized, ground, and polished so the first critical speed is at least 25% over the maximum operating speed. Close tolerances, where the shaft makes contact with bearings, results in longer bearing life.
- 5 **Bearings** – 100% factory tested and designed specifically for air handling applications with a minimum L10 life in excess of 100,000 hours (L50 average life of 500,000 hours).
- 6 **Motor Cover** – Constructed of aluminum. Attached with stainless steel fasteners for easy removal and access to the motor compartment and drive assembly.
- 7 **Drive Assembly** – Belts, pulleys and keys are oversized 150% of driven horsepower. Machined cast pulleys are adjustable for final system balancing. Belts are static-free and oil resistant.
- 8 **Motor Cooling** – Cooling fins located on top of fan wheel draw outside air through a large space between the fan shroud and the motor cover directly into the motor compartment. Positive motor cooling with fresh air results in maximum motor life.
- 9 **Vibration Isolation** – True vibration isolators contain two independent studs with rubber neoprene to support the drive assembly and wheel for long life and quiet operation. No steel-on-steel contact.
- 10 **Fan Shroud** – One-piece, heavy-gauge aluminum with a rolled bead for additional strength directs exhaust air towards the mounting surface. The curb cap and integral deep spun venturi are attached to the windband and constructed of aluminum to prevent corrosion.
- 11 **Mounting Holes** – Aluminum curb cap has pre-punched mounting holes to ensure correct attachment to the roof.
- 12 **Birdscreen** – Rigid wire protects the fan's discharge from birds and small objects.
- 13 **Curb Cap** – Curb cap (with integral deep spun venturi) is constructed of aluminum in one-piece for a weathertight fit.
- 14 **Lower Windband** – Heavy-gauge aluminum with formed edges for added strength and weather resistance.
- 15 **Motor** – Carefully matched to the fan load and mounted out of the airstream.
- 16 **Lifting Points** – Select models have various lifting points located on the drive frame or bearing plates.

Name Plate (not shown) – Permanent stamped aluminum plate for exact model and serial identification number.

Seismic Certification – Certified to IBC 2015, ASCE 7-10 and California OSHPD certification standards for all seismic design categories. OSHPD/OSP# 0148-10, SDS Value 2.28.

High Wind/Hurricane Zone Certification – Miami-Dade NOA for high wind and hurricane zones and Florida Product Approval.

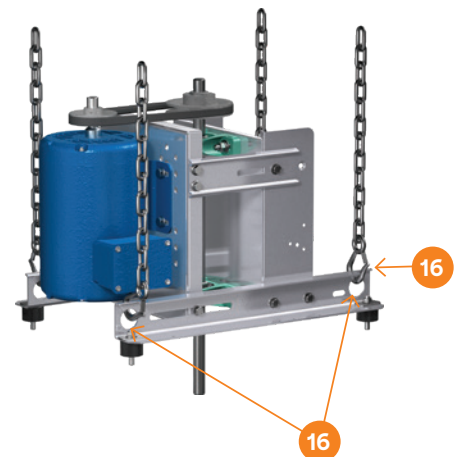
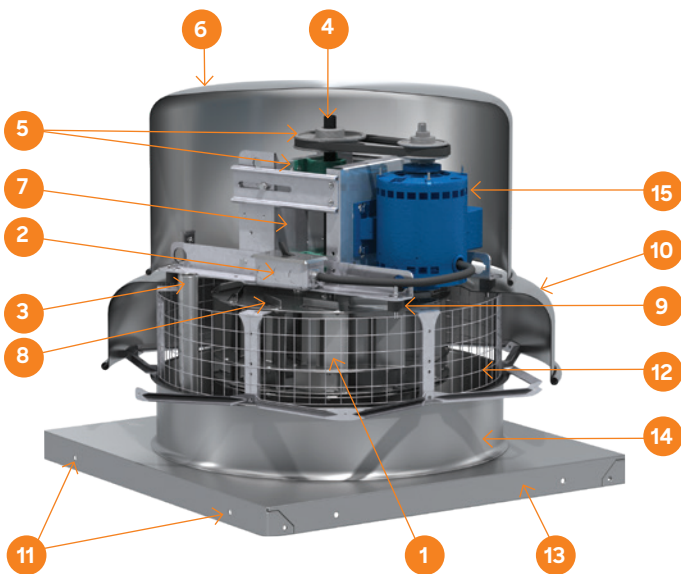

Greenheck Vari-Green® Motor

Availability for direct drive fans (select models).



Motor Information				
HP	RPM	Voltage	HZ	Phase
1/15	1725	115/208-230	60	Single
1/10	1725	115/208-230/277	60	Single
1/6	1725	115/208-230/277	60	Single
1/4	1725	115/208-230/277	60	Single
1/2	1725	115/208-230/277	60	Single
3/4	1725	115/208-230/277	60	Single
1	1725	115/208-230/277	60	Single
1	1725	208-240/380-480	60	3
2	1725	208-240	60	Single
2	1725	208-240/380-480	60	3
EXTENDED RPM MOTORS				
1/2	2500	115/208-230/277	60	Single
3/4	2500	115/208-230/277	60	Single

Speed Controllers for Greenheck Vari-Green Motor

- Motor mounted dial
- Control wire inputs (0-10V)
- Remote mounted dial



Speed Controllers – Available for use with shaded pole and permanent split capacitor (PSC) open motors on model XRED fans. Controllers provide an economical means of system balancing with direct drive fans.



Disconnect Switches – A wide selection of NEMA rated switches are available for positive electrical shutoff and safety, including dust-tight, rainproof, and corrosion-resistant. Switches may be internally or externally mounted.



Dampers – Designed to prevent outside air from entering back into the building when fan is off. Includes gravity and motorized dampers.



Birdscreen – Galvanized mesh is standard, optional aluminum or stainless steel rigid wire are also available.

Coatings– A wide variety of coatings and colors are available.

Permatector™ – is our standard coating. Typically used for applications that require corrosion resistance for indoor and outdoor environments.

Hi-Pro Polyester – Available in 7 standard decorative colors, Hi-Pro Polyester is resistant to saltwater, chemical fumes and moisture in more corrosive atmospheres. Typically used for applications that require superior chemical resistance, excellent abrasion and outdoor UV protection. This coating exceeds protective qualities of air dried Heresite and air dry phenolic. Available in seven colors.

UL Listed

- UL/cUL Listed 705 for Electrical – XREB and XRED File no. E40001
- Smoke Control – XREB is UL/cUL Listed for 500°F (260°C) for 4 hours and 1,000°F (538°C) for 15 minutes
- UL/cUL is optional and must be specified

XREB smoke control models are:
100, 100-HP, 120, 130, 140, 140-HP, 160, 160-HP, 200, 240, 300, 360, 420, 480



EMERGENCY SMOKE CONTROL MODEL XRED AND XREB

When you buy an Accurex model XRED or XREB, you receive a fan with the industry's best performance and durability for Smoke Control Applications (as found in emergency smoke control systems).

- The first spun aluminum UL/cUL Listed fan for Emergency Smoke Control Systems in the industry.
- UL/cUL Listed for 500°F (260°C) for 4 hours and 1,000°F (538°C) for 15 minutes.
- Half the weight of traditional smoke control fans, an ideal choice for roof load concerns.
- Low profile, height is less than half of traditional smoke control fans, maximum of 48 inches (1,219 mm) from curb cap to top of fan.
- Multiple applications, capable of exhausting general clean air and satisfying emergency smoke control regulations.

GREENHECK VARI-GREEN® MOTOR MODEL XRED

Greenheck's electronically commutated EC Vari-Green (VG) motor combines motor technology, controllability and energy efficiency into one single low maintenance unit and is the industry's first fully controllable motor. When combined with Accurex's XRED fans, all the CFM and static pressure ranges of a belt drive can be attained. Features are:

- Operates on AC power that's converted to DC— providing higher efficiency motor operation compared to an AC operation
- The motor can attain up to 85% efficiencies and reduce energy consumption
- Watt savings of 30-70% depending on RPM
Note: As motor speed is turned down, efficiency is maintained as compared to an AC motor with virtually no efficiency gains
- Runs cooler than a standard AC motor. A cooler running motor has a longer motor life and reduces energy consumption, see Motor Turndown Comparison chart at right
- 80% usable turndown vs. 30%
- The VG motor provides an easier solution for variable volume systems and system balancing

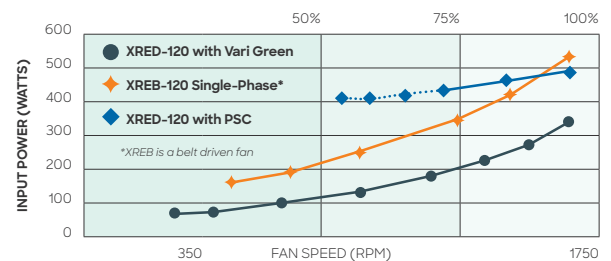

The length of each curve indicates the practical turndown range. Data is for 1/2 hp motors with load of 0.35 Bhp at full speed

Direct Drive Benefits – Direct drive fans are often preferred for motors where maintenance access is difficult. XRED fans with Greenheck Vari-Green motors can provide all the cfm and static pressure ranges of a comparable belt drive—and since there are no belts or bearings to replace and no pulleys to adjust, maintenance costs are reduced. Other benefits include:

- Compact housing design requires a smaller footprint
- Low vibration
- Suitable for clean air application - no belt or bearing residue in airstream
- Easy building system balancing

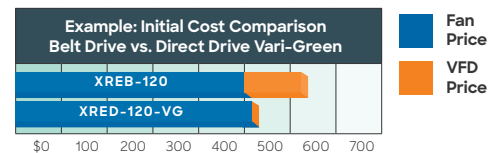

Constant Volume – Constant volume systems are more limited to applications where heating and cooling loads are constant. A typical application could be a dedicated computer room, where computers run 24 hours a day. Some disadvantages are limited control for comfort zones, high electrical/energy consumption and higher maintenance due to frequent starting and stopping.

Greenheck Vari-Green Motor Mounted Control

- A potentiometer (speed control dial) is attached to the motor for easy speed adjustment for building balance.
- Simply turn a dial instead of adjusting belts and pulleys.

Variable Volume – Variable volume or demand ventilation offers significant energy savings by only exhausting conditioned air when necessary throughout a day. This type of application can greatly reduce the operating costs associated with air conditioning and heating. Either a Greenheck Vari-Green® motor or standard variable frequency drive (VFD) compatible motor can function within a variable volume system and help reduce energy consumption.

Vari-Green Drive (VGD) – Greenheck's Vari-Green Drive is a factory mounted, wired, and programmed variable frequency drive. Specifically designed for use in air handling applications, the Vari-Green drive expands variable volume operation and simplistic speed adjustment to three-phase applications.

Variable Frequency Drive (VFD Rated) – For applications that require a higher horsepower. A VFD rated/compatible motor will also allow the fan performance to be adjusted. Although a comparable VFD rated motor is not as efficient as the Greenheck Vari-Green motor, it can still assist in system balancing and provide flexibility in adapting to system changes. It can also help reduce energy consumption. The motors meet NEMA Premium efficiencies.
Note: VFD rated motors will need VFD controllers by others and will require start-up programming.

Greenheck Vari-Green System Controls – A controlled system reduces the energy consumed by decreasing the speed of the fan and energy used by the motor. The system controls will lessen the amount of conditioned air that is exhausted, further reducing the total operating costs. For more detailed information refer to the Greenheck Vari-Green Motor brochure on accurex.com.

A 0-10 VDC control signal may be used in conjunction with:

- Greenheck Vari-Green system controls - for constant pressure
- Vari-Flow - controls based upon temperature
- CO2 Sensors - monitors carbon dioxide levels
- VOC Sensors - monitors a range of volatile organic compounds
- Motion Detectors - monitors occupancy



GREENHECK VARI-GREEN SYSTEM CONTROLS FOR VARIABLE VOLUME - XRED

This system is designed for applications requiring constant pressure control, variable volume or demand-controlled ventilation as used in multi-storied buildings such as hotels, multi-family complexes, institutional facilities, and high rise commercial buildings. The system utilizes XRED fans with a Greenheck Vari-Green motor, controller, pressure tap, and pressure transducer. It is preprogrammed and easy to install. Applications include, venting dryers, bathrooms, residential type kitchen space or industrial process exhaust.

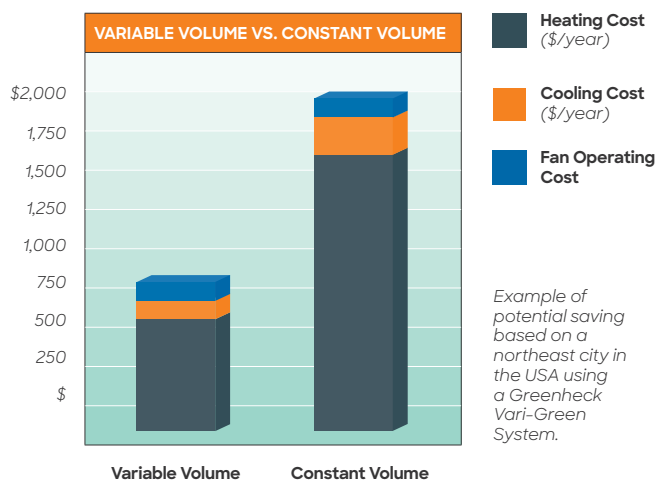
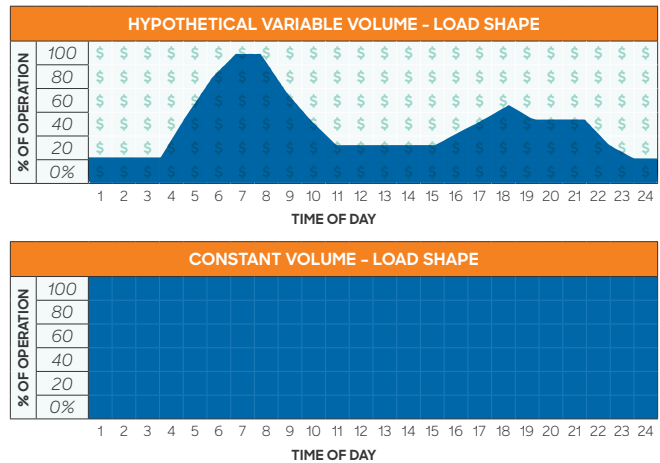

Roof Curbs – Prefabricated roof curbs reduce installation time and costs by ensuring compatibility between the fan, the curb and roof opening. A wide variety of roof curbs are available, including flanged, pitched and sound absorbing.



Hinged Curb Cap with Cables (Field Installed) – Mounted to the curb cap, allows the entire fan to tilt away from curb for access to wheel and ductwork. Includes restraint cables. Not available for high wind.

Hinged Base (Factory Mounted)
Allows for easy maintenance. Hinge and restraining cables are factory mounted to a subbase attached directly to curb without additional height added. Not available for high wind.

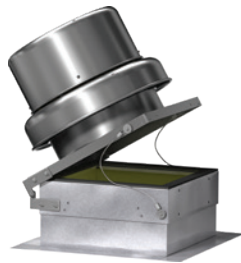

Curb Seal – Foam seal between fan and curb to ensure proper sealing when attached to a curb.

Curb Extensions – Extensions raise the fan discharge above the roofline and provide an accessible mounting location for dampers. Insect screen bases, constructed with a removable fine mesh, are recommended for applications where insect entry must be prevented.



High Wind and Severe Duty Roof Curbs –

Provided as optional with models XRED and XREB. The severe-duty roof curb models can ship separately to allow for final finishing of the roof prior to the fan arrival and installation.

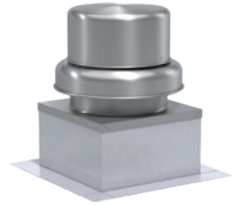

- **Model GPF** – This roof curb is specifically designed for high wind applications used on fan models XRED and XREB. Standard height is 12 inches (305 mm), fully welded straight sides with a 5-inch flashing flange. GPF is available up to 24 inches (460 mm) in height to meet greater height requirements.

- **Model GPFHL** – for heavy load applications. Its construction is intended to support compression loads exceeding 1,000 lbs (454 kg). GPFHL is mounted directly to the roof deck structure, and the roofing material is brought to the vertical surface and sealed to the flashing flange. Additional standard construction features include 14 gauge galvanized steel and internal vertical support members.

- **Model GPFHD** – for supporting heavy load equipment in severe-duty, high wind and seismic applications. The double-thick flashing flange provides an extremely durable surface to secure the curb to the building structure. The roofing material is brought to the vertical surface and sealed to the flashing flange. Additional standard construction features include 12 gauge galvanized steel and internal vertical support members.

Mounting details for the roof curb to the roof substrate and the fan to the curb are illustrated on the following page and are included with each model XRED and XREB installation manual.

OPTIONS AND ACCESSORIES	XREB	XRED
Hinge Kit	Optional	Optional
Roof Curbs	Optional	Optional
Curb Extension	Optional	Optional
Coatings	Optional	Optional
Disconnect Switches	Standard	Standard
Dampers	Optional	Optional
Birdscreen	Standard	Standard
Controls	Optional*	Optional
Curb Seal	Optional	Optional
Greenheck Vari-Green® Motor	-	Optional
Greenheck Vari-Green Controls	-	Optional
Greenheck Vari-Green Drive	Optional	Optional

*Only optional with VGD

Models XREB and XRED exhaust fans are designed to meet the needs of general clean air applications. Tests were conducted to ensure safe, rugged and reliable fans. Due to the varying airstreams encountered in commercial ventilation, system designers must be aware of national, state, and local codes and guidelines governing these installations. Local code authorities should be consulted before proceeding with any ventilation project.

Roof curbs should be 1½ inches (¾ inch on a side) less than the unit curb cap to allow for roofing and flashing.

Installation must include a means for inspecting, cleaning and servicing the exhaust fan.

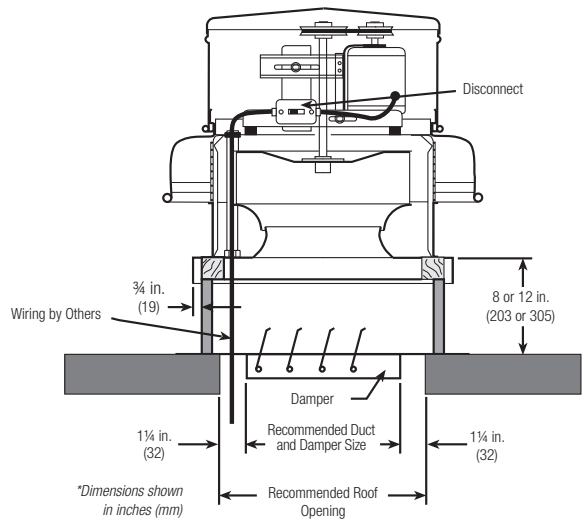

FAN INLET CONNECTIONS

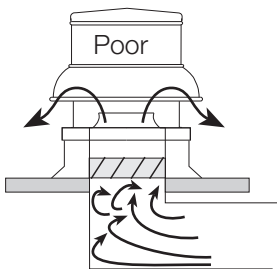

Dampers must open fully. Use motorized dampers in low airflow applications to reduce losses.

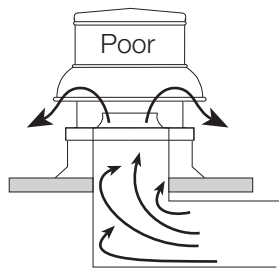

Avoid sharp turns or entrance conditions, which cause uneven flow. Use turning vanes in elbows to reduce adverse effects.

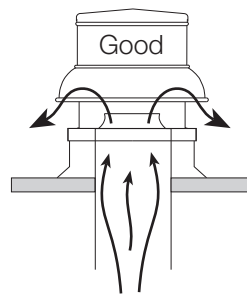

Provide uniform airflow at fan inlet to ensure optimum performance.

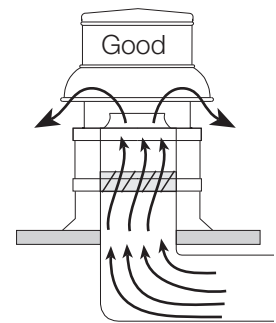

Provide uniform airflow at fan inlet and through the damper to ensure optimum performance. The curb cap should be three wheel diameters from the radius. Use turning vanes in duct when possible.

WHEEL ROTATION

Direction of rotation is very critical. Rotation in the wrong direction will result in excessive horsepower, possible motor burnout and increased noise levels. Check rotation by energizing the unit only momentarily. The rotation should be clockwise when viewed from the top of the unit and the same as the rotation decals affixed to the unit.

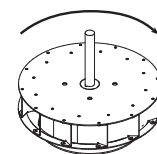

Clockwise Rotation

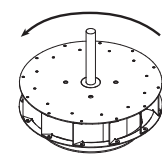

Counterclockwise Airflow

Ceiling and Cabinet Fans



Great things come in small packages, as do our ceiling fans (model XCR) and cabinet fans (model XIR). Be assured when you buy any Accurex product; you are getting a quality product at a competitive price. We guarantee our ceiling and cabinet fans with a three (3) year warranty. You will also receive these additional benefits with an Accurex ceiling and cabinet exhaust fan:

- Low sound and compact size
- Competitive price
- Broadest performance selections in the industry

MODEL OVERVIEW

Accurex's provides the most comprehensive ceiling and cabinet exhaust fan lines in the commercial market.

MODEL NUMBER CODE:

The Model Number Code is designed to completely identify the fan. The correct code letters must be specified to designate belt or direct drive, and roof or wall mounted configurations. The remainder of the model number is determined by the size and performance.

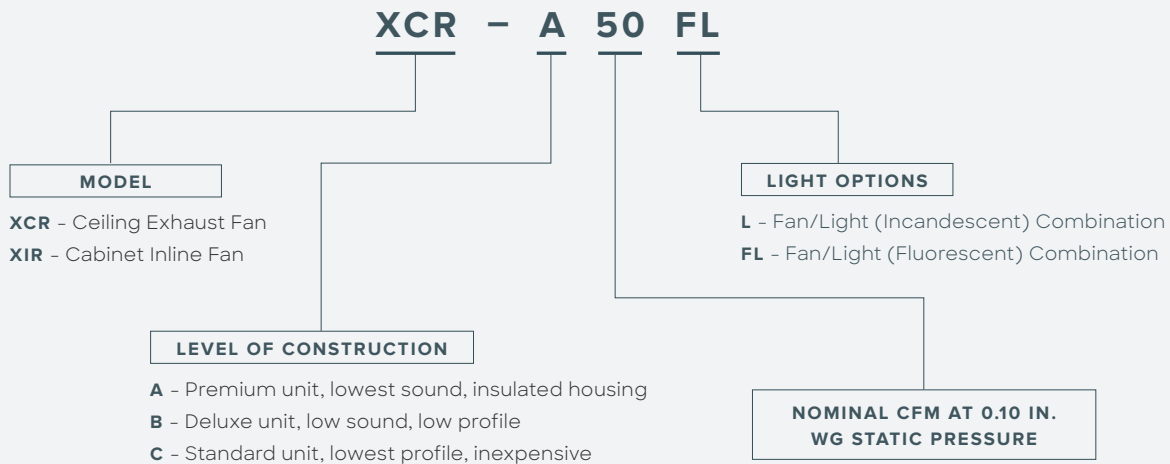

XCR FANS ARE DESIGNED FOR CEILING MOUNTED APPLICATIONS.
XIR FANS ARE DESIGNED FOR INLINE REMOTE MOUNTED APPLICATIONS.

XCR-A

The XCR-A is a premium ceiling fan. It is in the top of its class when it comes to meeting sound requirements.

- Sound levels as low as 0.5 sones
- Profile as low as 9 inches (22.8 cm)
- Air volume as high as 1,600 cfm (2,718 m³/hr)
- UL Listed for above bathtub/shower with GFCI branch protected circuit (sizes A390 and smaller)



XCR-B

The XCR-B is a deluxe ceiling fan compact enough for almost any application. If quiet is what you are after, this fan will accommodate your needs.

- Sound levels as low as 0.8 sones
- Profile as low as 7 inches (17.8 cm)
- Air volume as high as 200 cfm (340 m³/hr)
- UL Listed for above bathtub/shower with GFCI branch protected circuit



XCR-C

The XCR-C is our economy ceiling fan designed for light commercial applications.

- Sound levels as low as 3 sones
- Profile as low as 35/8 inches (7.6 cm)
- Air volume as high as 50 cfm (85 m³/hr)
- UL/cUL Listed



XIR-A

The XIR-A is a premium inline fan. It outperforms the competition and is preferred by specifying engineers.

- Sound levels as low as 0.8 sones
- Profile as low as 9 inches (22.8 cm)
- Air volume as high as 3,775 cfm (6,414 m³/hr)
- UL/cUL Listed



XIR-B

The XIR-B is a compact deluxe inline fan. It is designed to fit in small remote quarters.

- Sound levels as low as 1.5 sones
- Profiles as low as 7 inches (17.8 cm)
- Air volume as high as 185 cfm (314 m³/hr)
- UL/cUL Listed

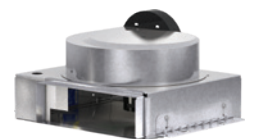

- 1 **Spring Loaded Aluminum Backdraft Damper** – Eliminates rattling or unwanted backdrafts.
- 2 **Outlet** – Square and round outlets are field rotatable from horizontal to vertical discharge.
- 3 **Power Assembly** – Removes quickly for maintenance, or conversion from horizontal to vertical discharge.
- 4 **External Electrical Access** – Eliminates removing motor pack, saving installation time.
- 5 **Electrical Knockouts (horizontal or vertical)** – Eliminates drilling holes.
- 6 **Acoustic Insulation** – Absorbs sound.
- 7 **Disconnect** – Servicing is quick and safe.
- 8 **Electrical Junction Box** – Large for easy wiring.
- 9 **Attractive Standard Grille** – Concealed attachment screws securely fasten grille to housing, for quiet and rattle-free operation.
- 10 **Mounting Brackets** – Fully adjustable for multiple installation conditions.
- 11 **Housing** – Embossed galvanized steel for rigidity.
- 12 **Motor** – All motors are compatible for use with speed controls and have thermal overload protection. Domestic and international applications are available.
 - 50 cycle, 220v, and 240v options
 - 60 cycle, 115v, 208v, 220v, 230v, and 277v options
- 13 **Double-Wide Fans** – Available for applications requiring 700 cfm or greater. Double-wide fans have two double-width forward-curved wheels, which are housed in separate scrolls and driven by a single motor.

Access Panel (not shown) – Gain easy access to internal components once installed.

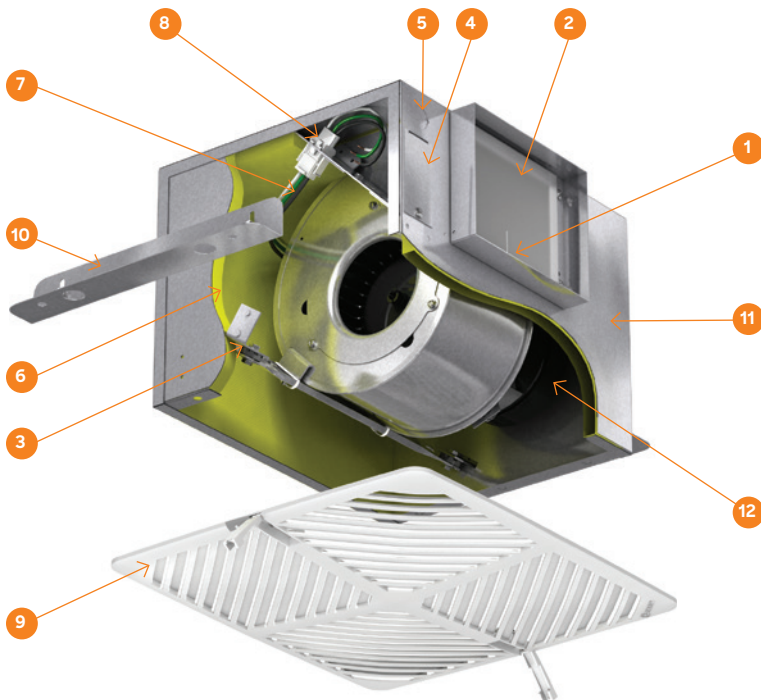

STANDARD CONSTRUCTION FEATURES XCR-B

- 1 Plastic Backdraft Damper** – Prevents unwanted backdrafts.
- 2 Round Standard Outlet (6 in.)** – Versatile for quick and easy connections.
- 3 Power Assembly** – Removes quickly for maintenance.
- 4 Electrical Access (vertical)** – Eliminates drilling holes.
- 5 Disconnect** – Servicing is quick and safe.
- 6 Electrical Junction Box** – Large for easy wiring.
- 7 Attractive Standard Grille** – Concealed attachment screws securely fasten grille to housing, for quiet and rattle-free operation.
- 8 Mounting Brackets** – Fully adjustable for multiple installation types.
- 9 Housing** – Embossed galvanized steel for rigidity and low profile for height restricted areas.
- 10 Motor** – All motors are compatible for use with speed controls and have thermal overload protection. Domestic and international applications are available.
 - 50 cycle, 220v, and 240v options
 - 60 cycle, 115v, 208v, 220v, 230v, and 277v options

Access Panel (not shown) – Gain easy access to internal components once installed.

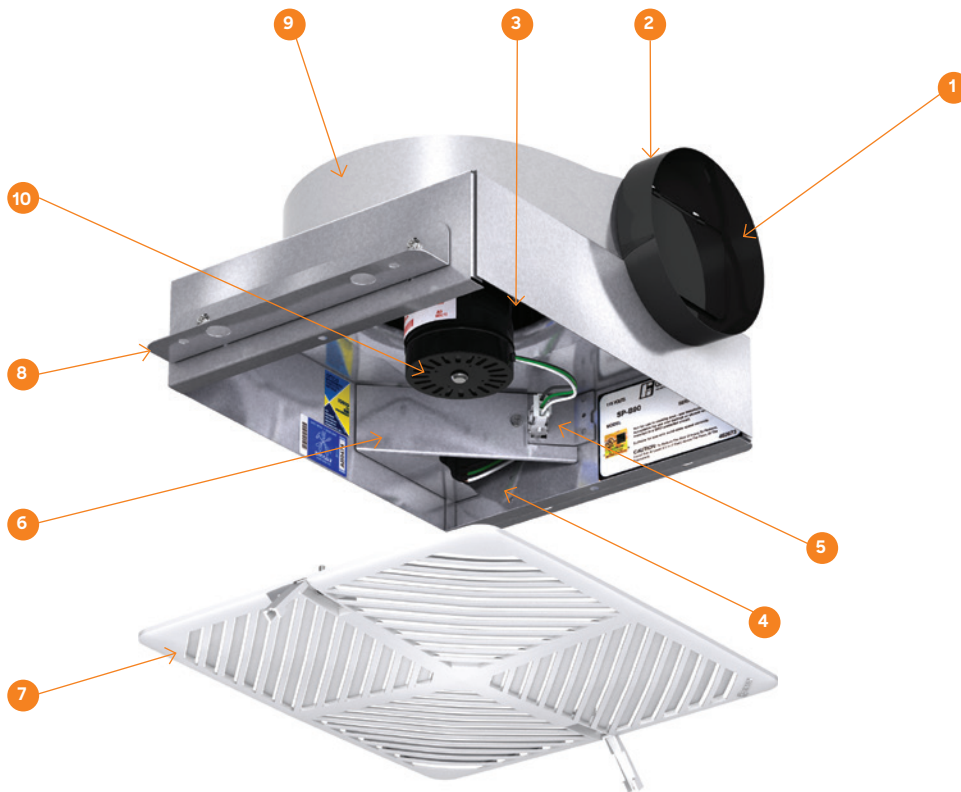

- 1 **Plastic Backdraft Damper** – Prevents unwanted backdrafts.
 - 2 **Round Outlet** – 3 inch diameter allows quick and easy connections.
 - 3 **Power Assembly** – Removes quickly for maintenance.
 - 4 **Disconnect** – Servicing is quick and safe.
 - 5 **Decorative Grille** – Quickly snaps into place.
 - 6 **Mounting Brackets** – Adjustable for several installation types.
 - 7 **Housing** – Galvanized steel for rigidity and low profile for height-restricted areas.
 - 8 **Motor** – Compatible for use with speed controls. Thermal overload protection.
· 60 cycle, 115v
- Access Panel** – Gain easy access to internal components once installed.

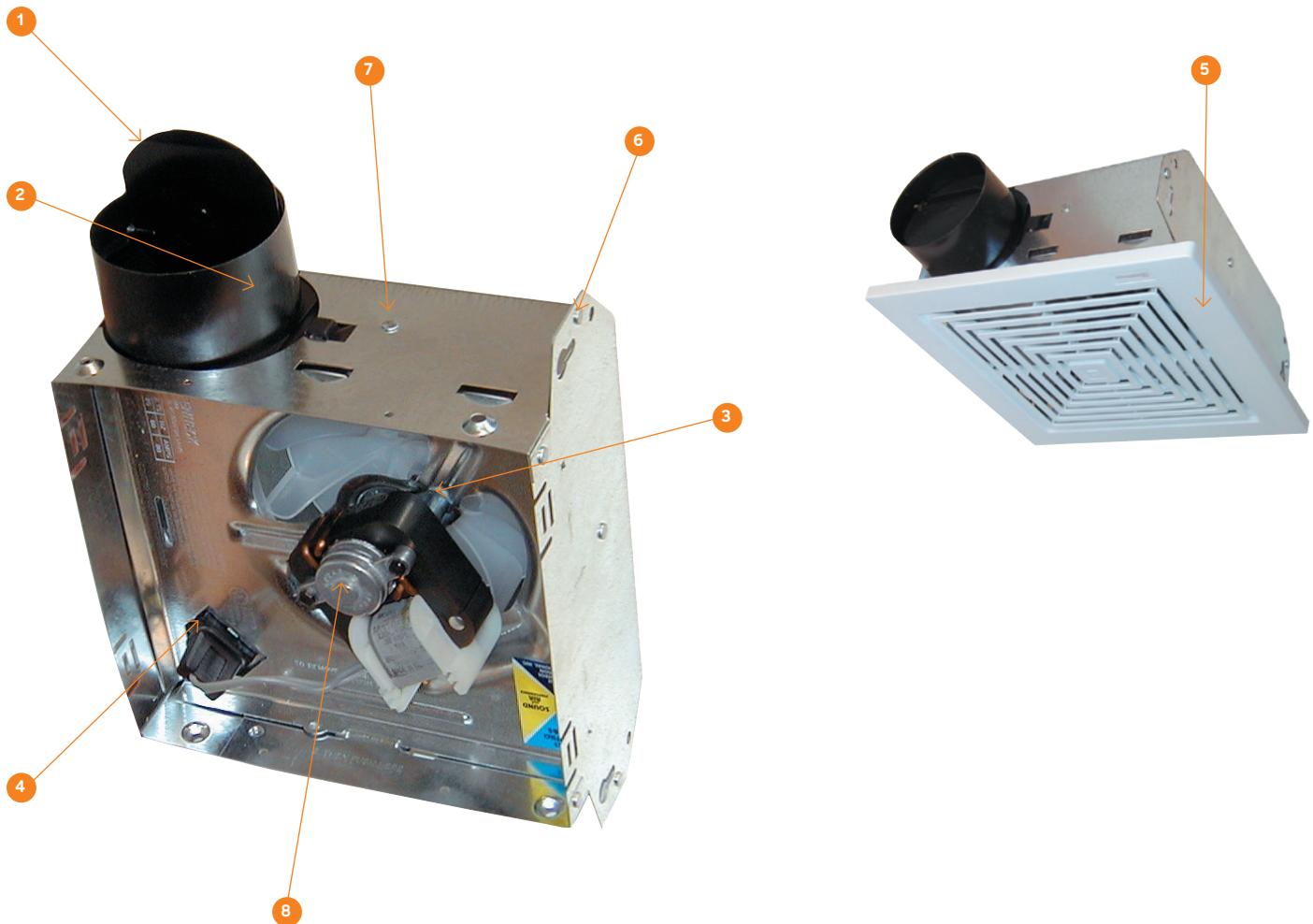

STANDARD CONSTRUCTION FEATURES XIR-A

- 1 **Spring Loaded Aluminum or Plastic Backdraft Damper** – Eliminates rattling or unwanted backdrafts.
- 2 **Outlet** – Square outlets are field rotatable from horizontal to vertical discharge.
- 3 **Power Assembly** – Removes quickly for maintenance or conversion from horizontal to vertical discharge.
- 4 **External Electrical Access** – Eliminates removing motor pack, saving installation time.
- 5 **Electrical Knockouts (horizontal or vertical)**
Eliminates drilling holes.
- 6 **Acoustic Insulation** – Absorbs sound.
- 7 **Disconnect** – Servicing is quick and safe.
- 8 **Electrical Junction Box** – Large for easy wiring.
- 9 **Access Panel** – Gain easy access to internal components once installed.
- 10 **Mounting Brackets** – Fully adjustable for multiple installation conditions.
- 11 **Housing** – Embossed galvanized steel for rigidity.
- 12 **Motor** – All motors are compatible for use with speed controls and have thermal overload protection. Domestic and international applications are available.
 - 50 cycle, 220v, and 240v options
 - 60 cycle, 115v, 208v, 220v, 230v, and 277v options
- 13 **Inlet Duct Collar** – Allows for the ductwork to slide over the duct collar to be fastened for faster and easier installation.
- 14 **Double-Wide Fans** – Available for applications requiring 700 cfm or greater. Double-wide fans have two double-width forward-curved wheels, which are housed in separate scrolls and driven by a single motor.

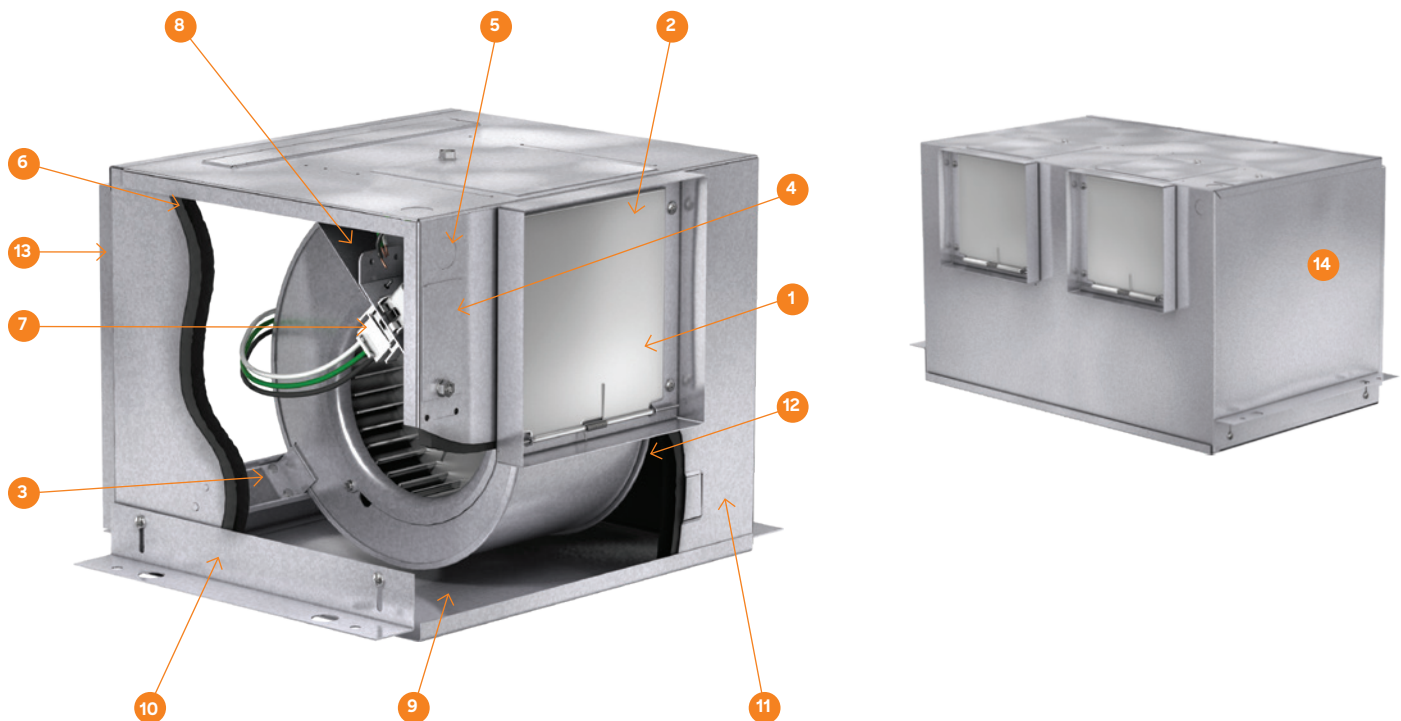

- 1 **Aluminum or Plastic Backdraft Damper** – Prevents unwanted backdrafts.
- 2 **Round Standard Outlet (6 in.)** – Versatile for quick and easy connections.
- 3 **Power Assembly** – Removes quickly for maintenance.
- 4 **Electrical Access (vertical)** – Eliminates drilling holes.
- 5 **Disconnect** – Servicing is quick and safe.
- 6 **Electrical Junction Box** – Large for easy wiring.
- 7 **Mounting Brackets** – Fully adjustable for multiple installation types.
- 8 **Housing** – Embossed galvanized steel for rigidity and low profile for height-restricted areas.
- 9 **Motor** – All motors are compatible for use with speed controls and have thermal overload protection. Domestic and international applications are available.
 - 50 cycle, 220v, and 240v options
 - 60 cycle, 115v, 208v, 220v, 230v, and 277v options
- 10 **Inlet Duct Collar** – Allows for the ductwork to slide over the duct collar to be fastened for faster and easier installation.
- 11 **Access Panel** – Gain easy access to internal components once installed.

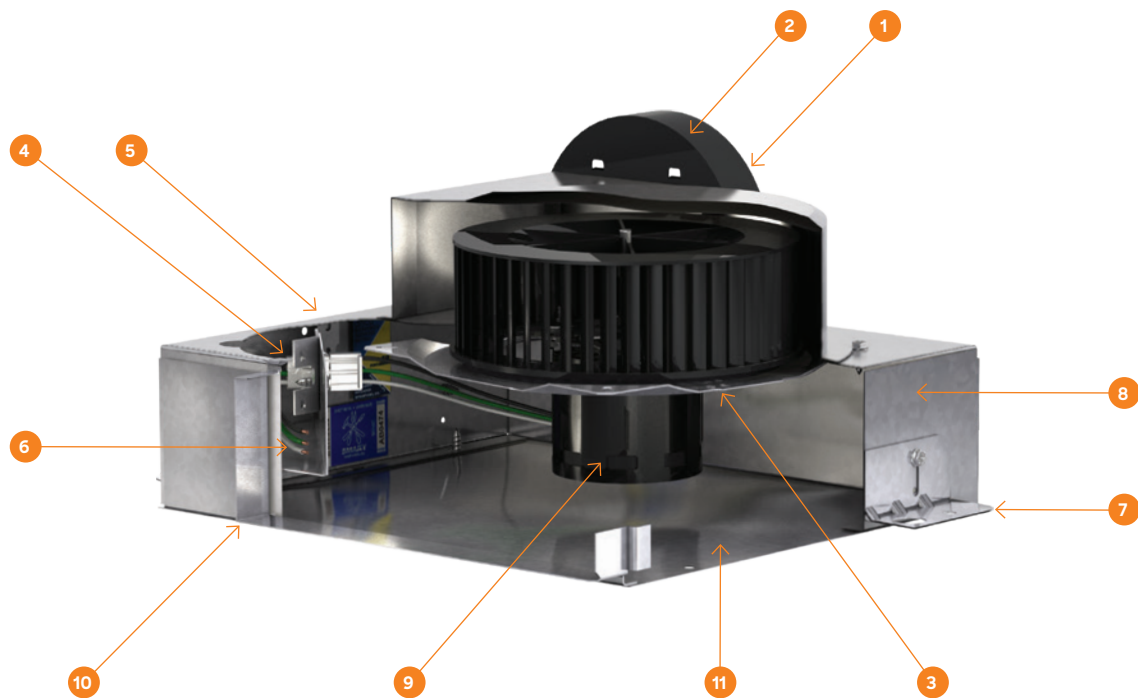

Grille Options –

- Standard Grille
- Aluminum – White enamel finish
- Stainless Steel – Polished stainless steel finish



Round Duct Connection –

Standard – Sizes A50, A70, and A90.



Round Duct Adapter –

Optional – Sizes A110 through A510.

Vertical Discharge – Exhaust outlet duct may be installed in the optional vertical position. The power assembly must be rotated to match the duct adapter position.

Wheel Options – Models XCR and XIR deliver high-performance from forward-curved wheels that offer both high-efficiency and low sound. Fan wheels are constructed of polypropylene or steel as standard and most models offer an aluminum wheel option.

- Level A models utilize steel or polypropylene wheel construction depending on size.
- Level B models are standard with a polypropylene wheel.



Greenheck Vari-Green® Motor – 1/6 or 1/4 hp electronically commutated motor with built-in speed control capability. 115v, 60 Hz, single-phase power. XCR-A510, XCR-A710, XCR-B510, XCR-B710 only.

Double-Wide Fans – Available for applications requiring 700 cfm or greater. Double-wide fans have two double-width forward-curved wheels, which are housed in separate scrolls and driven by a single motor.



Contractor 4 Paks – Save installation time and labor by installing the housing first, then installing the internal components after the sheetrocking, plastering and finishing is done.

- Housings are packaged in one box, power assembly and grille are packaged in another box.
- Components are shipped to coincide with the phase of your project.

Exclusive Electrical Wiring Feature – Accurex XCR-A models are the only fans of this type with an electrical access cover located on the housing exterior. This feature permits external wiring without removing the power assembly, saving installation time and cost.

LIGHT OPTIONS

Accurex's fan/light combination utilizes our LED panel grille. *UL Listed for above bathtub/showers with GFCI branch protected circuit.* Available on **XCR-A Sizes 50 - 390, XCR-B Sizes 50-200.**

LED PANEL GRILLE

Greenheck's LED panel light grilles can be selected with built-in motion detector or combination motion and de-humidistat. LED panel grilles can also be used in conjunction with an integrated Greenheck de-humidistat. The LED panel is Energy Star and UL Listed for above bathtub and showers with GFCI branch protected circuits. Its color is 3000k, it runs on 115V AC at 60HZ, and gives off 800 lumens. Light emitting diodes (LED) are housed in a panel assembly PN:386735.

Note: Our LED Panels are ENGERY STAR certified. Not all fan/lighted grille options are ENERGY STAR certified. See CAPS for availability.

SPEED CONTROLS

Speed controls may be used on model XCR and XIR fans for manual adjustment of the fan’s performance (for final system balancing) or to control the fan’s output in confined spaces, such as conference or meeting rooms. The fan can be adjusted to 60% of design airflow with a speed control. This reduction in airflow and fan speed is also accompanied by a reduction in noise level. Solid-state speed controls are available for a range of applications up to 15 amps. Speed controls can be used to operate more than one fan if the combined total amperage of the fans does not exceed the control rating.



SWITCHES

Switches may be used on models XCR and XIR fans to enable manual control of your fan or fan/light combination. There are several options to fit your application.



1 Function – Single pole rocker switch assembly.

- Rated for 120-277v, 15 amp
- UL Listed



1 Function with Pilot Light – Single pole rocker switch assembly with cover and pilot light.

- Rated for 120v, 15 amp
- UL Listed



2 Function – Two single pole combination switch assembly.

- Rated for 120v, 15 amp, 2 hp
- UL Listed

Model 6WSSC – For use with shaded pole and PSC motors. Available shipped loose or mounted internal or external.

- Rated for 115 - 127v, 6 amp
- UL Listed
- Require a 2x4 handy box

Model 5W240 – For use with shaded pole and PSC motors. Available shipped loose or mounted internal or external.

- Rated for 220 - 240v, 5 amp
- UL Listed
- Requires 2x4 handy box

Model 5W277 – For use with shaded pole and PSC motors. Available shipped loose or mounted internal or external.

- Rated for 277v, 5 amp
- UL Listed
- Requires 2x4 handy box

Model 8WSSC – For use with shaded pole and PSC motors. Available shipped loose or mounted external.

- Rated for 220 - 240v, 8 amp
- UL Listed
- Requires 2x4 handy box

Model 10WSSC – For use with shaded pole and PSC motors. Available shipped loose or mounted external.

- Rated for 115 - 127v, 10 amp
- UL Listed
- Requires 4x4 handy box

Model 15WSSC – For use with shaded pole and PSC motors. Available shipped loose or mounted external.

- Rated for 115 - 127v, 15 amp
- UL Listed
- Requires 4x4 handy box

TIME DELAY SWITCH

Time delay switches save energy by automatically turning off equipment. They may be used with models XCR and XIR fans and fan/light combinations, for extended operating time of fan. Time delay switches act in the same manner as a standard switch, however, there is a delay of 10, 20, 30, and 60 minutes after the switch has been turned off.

Single-switch controls both fan and light. Available shipped loose.

- Silent operation
- Rated for 120v
- UL Listed
- Requires 2x4 handy box



MOTION DETECTORS

Motion detectors may be used with models XCR and XIR fans, or fan and light combinations. Motion detectors use a passive infrared motion detector that will automatically turn on the fan when a change in motion is sensed. They have a viewing area of 180 degrees, however, they must be placed in the line-of-sight.

Grille Motion Detectors

- Available on models up through size XCR-A390 and XCR-B200
- Rated for 115v
- UL Listed
- Adjustable time delay shut off setting for 30 seconds to 20 minutes

Model 385246

- Available shipped loose
- For use on fan or lights
- Rated for 115v
- UL Listed
- Requires 2x4 handy box
- Adjustable time delay shut off setting for 30 seconds to 20 minutes

TRANSFORMERS

Transformers are available for applications requiring voltage reduction. Selection is based on motor amperage. All transformers are shipped loose.

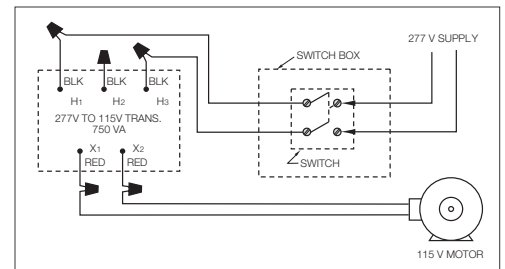

Model T-2.0 – UL Listed

- Rated for 230/277v to 115, 2 amps

Model T-4.3 – UL Listed

- Rated for 230/277v to 115, 4.3 amps

Model T-6.5 – UL Listed

- Rated for 230/277v to 115, 6.5 amps

Model T-8.6 – UL Listed

- Rated for 230/277v to 115, 8.6 amps

CEILING RADIATION DAMPERS

The Accurex XCR-A and XCR-B ceiling radiation dampers are UL Classified, rated at three hours fire resistance, and are available on all XCR-A and XCR-B fans and fan/light combinations. This design saves space by allowing the damper to mount directly beneath the fan.

XCR Model	CRD	LENGTH	WIDTH	HEIGHT
A50 - A190	310	13½	11½	3
B50 - B200 A200 - A390	320	14¾	12¼	3
A410 - A510 A710, A780	350	18¾	14 13/16	3
A700	700	24¾	12¼	3
A900 - A1550	360	24¾	14 13/16	3

All dimensions shown in inches.
Add an "L" to all CRD models if fan & light combo is used.

Model XCR-A

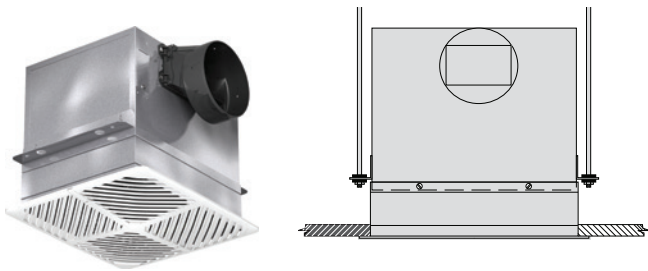

Model XCR-B

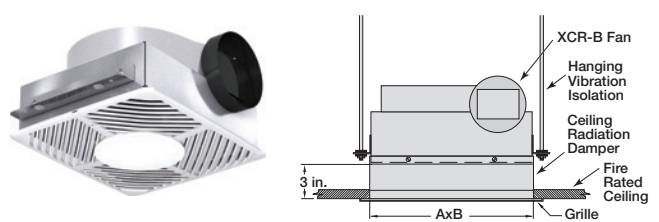

FILTERS

Fans used in most applications, even where air is not excessively dirty, will collect airborne dirt on wheels and motors over time. Accumulations of dirt on the fan wheel will sharply reduce performance and cause imbalance. Dirt buildup on the motor can cause it to overheat. All of these conditions will shorten the life of the fan. To help reduce this accumulation, washable aluminum mesh filters are available to trap dirt before it enters the fan. These filters should be regularly cleaned to maintain performance. The Filter Loss Chart shows the effect the filter will have on performance. To determine the added resistance, divide the desired cfm by the filter area (ft²). This will give ft/min. Use this with the filter loss chart to get the added resistance. In addition to reducing dirt accumulations on the motor and wheel, filters also reduce sound levels.

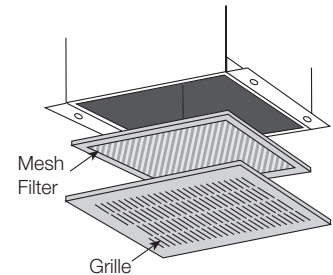

XCR Model	*Metal Grille	FILTER AREA (ft ²)
A50 - A190	F-210	.739
B50 - B200 A200 - A390	F-220	.911
A410 - A510 A710, A780	F-250	1.518
A900 - A1550	F-260	2.078

*Aluminum or Stainless Steel Grille.

Filter Loss Chart

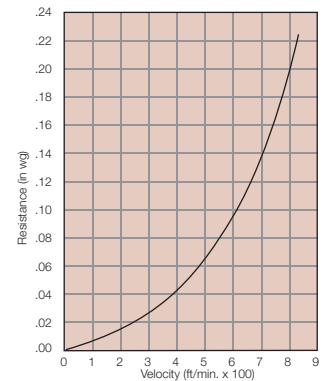

OPTIONS AND ACCESSORIES	XCR-A	XCR-B	XCR-C	XIR-A	XIR-B
Grille Options	Standard	-	-	-	-
Electrical Wiring Feature	Standard	Optional	-	Standard	-
Vertical Discharge	Optional	Standard	-	Optional	-
Greenheck Vari-Green Motor	Optional (A510, A710 only)	Optional (A510, A710 only)	-	-	-
Double-Wide Fans	Optional	Optional	-	Optional	-
Contractor 4 Paks	-	-	-	-	-
Light options					
LED Panel Grille	Optional	Optional	-	-	-
Speed Controls					
Model 6WSSC	Optional	Optional	Optional	Optional	Optional
Model 5W240	Optional	Optional	-	Optional	Optional
Model 5W277	Optional	Optional	-	Optional	Optional
Model 8WSSC	Optional	Optional	-	Optional	Optional
Model 10WSSC	Optional	Optional	Optional	Optional	Optional
Model 15WSSC	Optional	Optional	Optional	Optional	Optional
Switches					
1 Function	Optional	Optional	Optional	Optional	Optional
1 Function with Pilot Light	Optional	-	-	-	-
2 Function	Optional	-	-	-	-
Time Delay Switch					
874214	Optional	Optional	-	Optional	Optional
Motion Detectors					
385246	Optional	Optional	-	Optional	Optional
Transformers					
Model T-2.0	Optional	Optional	Optional	Optional	Optional
Model T-4.3	Optional	Optional	Optional	Optional	Optional
Model T-6.5	Optional	Optional	Optional	Optional	Optional
Model T-8.6	Optional	Optional	Optional	Optional	Optional
Dampers					
Ceiling Radiation Damper	Optional	Optional	-	-	-
Filters					
Filters	Optional	Optional	-	-	-
Wall Discharge					
6 x 4 Transition Duct Reducer	Optional	Optional	-	Optional	-
Model WC (Round Connection)	Optional	Optional	Optional	Optional	Optional
Model WC (Square/Rect. Connection)	Optional	Optional	Optional	Optional	Optional
Model WL	Optional	Optional	Optional	Optional	Optional
Model BVE	Optional	Optional	Optional	Optional	Optional
Model RDC	Optional	Optional	Optional	Optional	Optional
Roof Discharge Accessories					
Model RJ (Pitched Roof Curb)	Optional	Optional	Optional	Optional	Optional
Model RCC-7	Optional	Optional	Optional	Optional	Optional
Model GRS	Optional	Optional	Optional	Optional	Optional
Model RFC-7	Optional	Optional	Optional	Optional	Optional
Model GRSF	Optional	Optional	Optional	Optional	Optional
Hanging Vibration Isolators	Optional	Optional	Optional	Optional	Optional

Roof Curbs

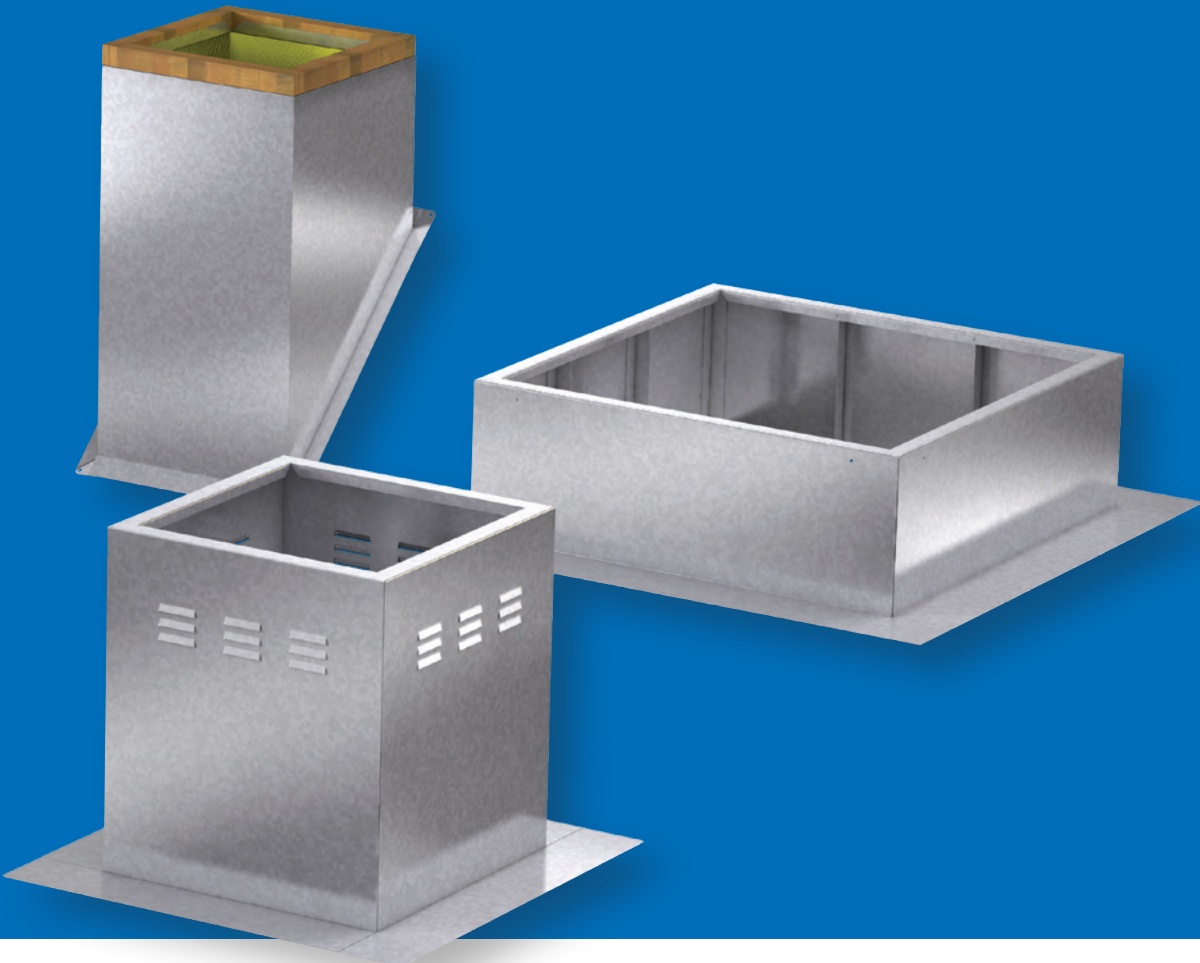

Accurex offers a wide variety of prefabricated roof curbs. Available roof curbs include: flanged, straight-sided, canted, pitched, ridged, vented, and sound absorbing.

Curb extensions are also available to raise the fan’s discharge or provide an accessible mounting location for dampers. Insect screen bases and vented extensions are also available.

MODEL OVERVIEW
 Reduce installation time and costs by ensuring compatibility between the fan, curb and roof opening.

MODEL NUMBER CODE:

The Model Number Code is designed to completely identify the roof curb. The correct code letters must be specified to designate configurations and size.

Square Curbs

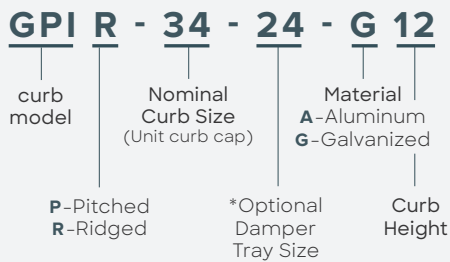

Rectangular Curbs

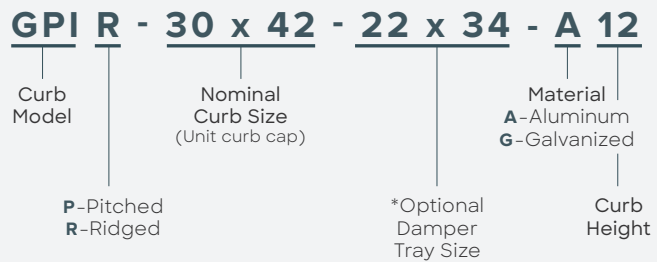

Models GPI, GPIP and GPIR

Models GPI, GPIP and GPIR are standard with fully welded construction, wood nailer, 1-inch insulation, and 2-inch flashing flange. Model GPI is for use on flat roofs, GPIP for pitched roofs and GPIR is available for ridged (double-pitched) roofs. Models are available in heights of 12 to 42 inches.

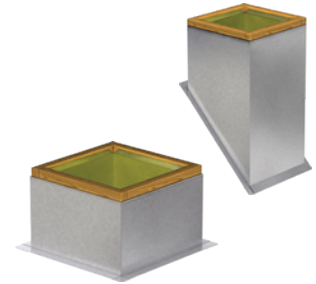

Models GPF, GPFV and GPFR

Models GPF, GPFV and GPFR are standard with fully welded construction. Model GPF is for flat roofs, GPFV is for pitched roofs and GPFR is available for ridged (double-pitched) roofs. Models are available in heights of 8 to 42 inches.

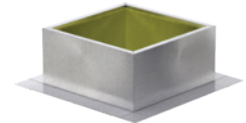

Model GPS, GPR

These curbs are designed for use on flat roof decks. They consist of a fully welded body and 1 inch of insulation. Model GPS is available in heights of 8 inches to 20 inches with a canted design. Raised cant is available on model GPR.

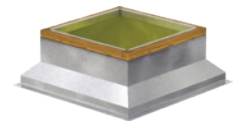

Model GPFV, GPFVP, and GPFVR

The vented roof curb is typically used for kitchen applications, where the vents allow hot air and gases to escape between the ductwork and roof curb. Model GPFV is for use on flat roofs, GPFVP for pitched roofs and GPFVR is available for ridged (double pitched) roofs. They are designed for use with Accurex's model XRUB, XRUBS or XRUD fan to provide the required 40-inch minimum discharge height above the roofline (per NFPA 96).



OPTIONS AND ACCESSORIES

- Damper trays
- Insulation (all except GPE, GPFV, GPFVP, GPFVR and VCE)
- Step for insulation (GPR only - up to 6 in.)
- Double shell construction (all except GPE, GPFV, VCE)
- Single pitch (GPI and GPF)
- Ridge mount (GPI and GPF)

Roof Type/Application	Description	Model and Service
Flat, pitched or ridged, insulated or non-insulated roof decks	Welded, straight-sided construction with rigid fiberglass insulation and 2-inch mounting flange	GPI - All types, sized to meet your requirements
Flat, insulated or non-insulated roof decks	Welded, canted construction with rigid fiberglass insulation	GPS - All types, sized to meet your requirements
Flat, pitched or ridged, non-insulated roof decks	Welded, straight-sided construction with rigid fiberglass insulation and 2 or 5-inch mounting flange	GPF - All types, sized to meet your requirements
Flat, insulated roof decks	Welded, raised cant construction with rigid fiberglass insulation	GPR - All types, sized to meet your requirements
Adaptors/Reducers	Used to match new fans to existing roof curbs. Welded galvanized steel or aluminum.	Curb adaptors and reducers

For complete product information contact your local Accurex representative.

Models GESS and GESR

These equipment supports are designed for use on both insulated (GESR) and non-insulated (GESS) flat roof decks. A variety of sizes and widths are available. Models GESS and GESR are available in welded aluminum or galvanized steel. Available in heights of 8, 12 and 14 inches and widths of 4, 6 and 8 inches.



Model GESI

This equipment support is designed for use on a flat or single pitched roof. Standard construction consists of welded galvanized steel with an option for aluminum in a variety of lengths to match the size of your equipment. Model GESI has heights ranging from 8 to 18 inches and widths of 4, 6, or 8 inches are available.



Models GPE and GPEX

Both curb extension models mount between the fan and roof curb. Heights range from 12 up to 24 inches. Models consist of welded aluminum or galvanized steel. The GPE is designed with an access door to provide easy access to the damper and damper actuator as well as fulfilling additional height requirements. The GPEX is also designed to provide additional height requirements without an access door.



Model VCE

The VCE vented curb extension is typically used in kitchen applications, where the vents allow hot air and gases to escape between the ductwork and the roof curb. Designed for use with an 8-inch high roof curb and Accurex's model XRUB, XRUBS or XRUD fan to provide the required 40-inch minimum discharge height above the roof (per NFPA 96). Model VCE is available in galvanized steel or aluminum.



Model ISB

Insect screen bases are available for applications where the building must be free of insects, as in food processing operations. Insect screen bases mount between the supply fan and the roof curb and provide an additional 6 inches of height. Two bolted access doors are provided for removal and cleaning of the screen. Model ISB is constructed of galvanized steel or aluminum with a fine mesh screen made of aluminum or stainless steel.



Adapters and Reducers

Used to adapt or reduce the standard fan curb cap dimensions to a non-standard specified curb size, within 10 inches of standard. Adapters and reducers are most commonly used to match new fans to existing roof curbs. Construction consists of welded galvanized steel or aluminum.

