

## Prodigi™ Pro Control

6-10E Pro  
10-10E Pro  
7-20E Pro  
10-20E Pro  
20-10E Pro  
20-20E Pro

6-10G Pro  
10-10G Pro  
7-20G Pro  
10-20G Pro  
20-10G Pro  
20-20G Pro



**MN-47965-EN**

REV.04  
05/24

**EN**

For the most current manual, visit [alto-shaam.com](http://alto-shaam.com)  
Die neueste Fassung des Handbuchs finden Sie auf [alto-shaam.com](http://alto-shaam.com)  
Pour la dernière version du manuel, visitez [alto-shaam.com](http://alto-shaam.com)  
Para obtener el manual más actual, visite [alto-shaam.com](http://alto-shaam.com)  
Ga voor de meest recente handleiding naar [alto-shaam.com](http://alto-shaam.com)



# Manufacturer's Information

---

## Copyright

© Copyright 5/24 by Alto-Shaam, Inc.

All rights reserved.

This manual or any portion thereof may not be reproduced or used in any manner whatsoever without the express written permission of Alto-Shaam, Inc.

---

## Trademarks

All trademarks referenced in this documentation are the property of their respective owners.

---

## Manufacturer

Alto-Shaam, Inc.

P.O. Box 450

W164 N9221 Water Street

Menomonee Falls, WI 53052

---

## Original instructions

The content in this manual is written in American English.



**DANGER:** Before starting the oven, make sure you do not detect the odor of gas.

If you smell gas:

- Shut off the gas supply immediately.
- Do not attempt to light any appliance.
- Do not touch any electrical elements.
- Extinguish any open flame.
- Evacuate the area.
- Use a telephone outside of the property and immediately contact your gas supplier.
- If unable to contact your supplier, contact the fire department.

## Enjoy your Alto-Shaam Prodigi™ Oven!

---

The Alto-Shaam Prodigi oven combines a steam and convection oven into one versatile unit and can serve a variety of cooking functions. Alto-Shaam's Prodigi ovens allow chefs to control humidity and temperature separately, with powerful results. The same oven can be used to dehydrate vegetables, roast pork, steam rice, smoke brisket and bake loaves of bread. The recipe management system with one-touch cooking provides complete control over the oven, allowing chefs and foodservice employees to select pre-programmed recipes for maximum consistency. To store and secure important information, a HACCP data system pairs up with an onboard USB port, so settings can be downloaded and saved for the future. When it's time to clean up, Alto-Shaam's automated cleaning system saves labor previously spent scrubbing the oven cavity. On the oven's exterior, a retractable hose gives you spray-washing power without opening the oven door.

## Extend Your Manufacturer's Warranty

---

### Register

Register your Alto-Shaam appliance online. Registering your appliance ensures prompt service in the event of a warranty claim.

Your personal information will not be shared with any other company.

[alto-shaam.com/warranty](http://alto-shaam.com/warranty)

## Alto-Shaam 24/7 Emergency Repair Service

---

### Call

Call 800-558-8744 to reach our 24-hour emergency service call center for immediate access to local authorized service agencies outside standard business hours. The emergency service access is provided exclusively for Alto-Shaam equipment and is available throughout the United States through Alto-Shaam's toll free number.

### Availability

Emergency service access is available seven days a week, including holidays.

This page is intentionally left blank.



Manufacturer’s Information . . . . . 2

**Foreword** . . . . . 3

    Enjoy your Alto-Shaam Prodigi™ Oven! . . . . . 3

    Extend Your Manufacturer’s Warranty . . . . . 3

    Alto-Shaam 24/7 Emergency Repair Service . . . . . 3

**Table of Contents** . . . . . 5

**Safety** . . . . . 7

    The Meaning of Signal Words . . . . . 7

    Appliance Description and Intended Use. . . . . 8

    Safety Precautions. . . . . 9

**Labels** . . . . . 13

    Labels. . . . . 13

**Operation** . . . . . 21

    How to Turn On and Turn Off the Oven . . . . . 21

    Icon Identification. . . . . 22

    How to View and Set up WiFi Connection. . . . . 25

    ChefLinc Installation Checklist. . . . . 28

    How to Set up an Ethernet Connection . . . . . 30

    How to Preheat the Oven. . . . . 32

    How to Cook with Programmed Recipes . . . . . 33

    How to Cook in Manual Mode . . . . . 35

    How to Cook in Professional Mode . . . . . 40

    How to Use the Multiple Timers . . . . . 44

    How to Prepare the Smoker Box for Smoking . . . . . 49

    How to Hot Smoke in Manual Mode . . . . . 50

    How to Cook using the Delta-T Core Temperature Cooking Mode . . 55

    How to Lock and Unlock the Screen. . . . . 60

    How to Cool Down the Oven. . . . . 61

    How to Create a Recipe . . . . . 62

    How to Modify, Duplicate, or Delete a Recipe . . . . . 67

    How to Create a Category . . . . . 69

    How to Backup or Restore Settings with a USB Drive. . . . . 72

    How to Load Recipes from a USB Drive. . . . . 74

    How to Save Recipes to a USB Drive . . . . . 76

    How to Update Software with a USB Drive. . . . . 78

    How to Change the Home Screen . . . . . 81

    How to Change the Temperature Scale. . . . . 83

    How to Enable/Disable the Handle Light . . . . . 85

    How to Enable/Disable Automatic Preheat. . . . . 87

    How to Enable and Use the Replay Function. . . . . 89

How to Lock Recipe Editing, Manual Cooking, or the Settings Screen	91
How to View Oven Information . . . . .	93
How to Download HACCP Data . . . . .	94
How to Calibrate the Temperature Probe . . . . .	96
<b>Maintenance</b>	<b>99</b>
Maintenance Schedule . . . . .	99
How to Clean the Oven using Cleaning Tablets . . . . .	101
How to Clean the Oven using Liquid Clean (if equipped) . . . . .	105
How to Descale the Oven . . . . .	109
How to View the Cleaning Log . . . . .	110
How to Set the Cleaning Time. . . . .	112
How to Winterize the Oven . . . . .	115
<b>Troubleshooting</b>	<b>117</b>
Error Codes . . . . .	117
<b>Notifications</b>	<b>123</b>
Notifications. . . . .	123
Conditions for Ovens Installed in New York City . . . . .	126
<b>Warranty</b>	<b>127</b>
Warranty. . . . .	127
<b>Declaration of Conformity</b>	<b>129</b>

# The Meaning of Signal Words

This manual contains signal words where needed. These signal words must be obeyed to reduce the risk of death, personal injury, or equipment damage. The meaning of these signal words is explained below.

**DANGER**

Danger indicates a hazardous situation which, if not avoided, will result in serious injury or death.

**WARNING**

Warning indicates a hazardous situation which, if not avoided, could result in serious injury or death.

**CAUTION**

Caution indicates a hazardous situation which, if not avoided, could result in minor or moderate injury.

**NOTICE**

Notice indicates a situation which, if not avoided, could result in property damage.



**NOTE:** Note indicates additional information that is important to a concept or procedure.

# Appliance Description and Intended Use

---

**Appliance description**

Engineered for dependability, connectivity, and cost savings, Prodigy™ combination ovens are an all-in-one solution for efficient and consistent food production. These ovens do the work of a convection oven, kettle, steamer, fryer, smoker and more. With advanced features and accessories, Prodigy combination ovens are designed to support—and connect—the most demanding kitchens.

---

**Intended use**

The appliance is intended for use in commercial establishments where all operators are familiar with the purpose, limitations, and associated hazards of this appliance. Any other use is prohibited. This appliance is intended to be used for commercial applications, for example in kitchens of restaurants, canteens, hospitals and in commercial enterprises such as bakeries, butcheries, etc., but not for continuous mass production of food.

---

**Residual risks**

This oven is manufactured using ISO-certified processes. The oven is designed with maximum safety in mind; however, there are residual risks to operators of this oven. Residual risks include exposure to heat and exposure to hot food products.

---

**Possible misuse**

Misuse of this oven includes loading the oven with anything other than a food product. Misuse also includes heating or cooking any food product that contains alcohol or other flammable substance.

# Safety Precautions

---

## Before you begin

Read and understand all instructions in this manual.

---

## Electrical precautions

Obey these electrical precautions when using the appliance:

- All electrical connections must be made by a qualified and trained service technician in accordance with applicable electrical codes.
  - Consult local codes and Specification Sheets for the electrical cable and breaker size.
  - Power source must match voltage identified on appliance tag.
  - CE-approved appliances include an equipotential-bonding terminal marked with the equipotential symbol.
  - For CE models, use a Type B current protection device that accommodates a leakage current of 30mA.
- 

## Gas precautions

Obey these gas precautions when using the appliance:

- Only use the oven when the exhaust hood is turned on.
  - Keep the area around the oven clear of any obstructions that might slow down the flow of cooling air.
  - Do not place objects near the oven's exhaust vents.
  - Do not touch the exhaust vents while the oven is running or immediately after it has been turned off.
  - Do not spray aerosols in the area of the oven during operation.
  - Do not store flammable materials in the area of the oven.
- 

## Usage precautions

Obey these usage precautions when using the appliance:

- Only use this appliance for its intended use of heating or cooking food.
- Always keep liquids, or foods that can become liquid when heated, level and at or below eye level where they can be seen.
- Always open the oven door slowly. Escaping hot vapors or steam can cause injury.
- Use utensils and protective clothing such as dry oven mitts when loading and unloading the appliance.
- Use caution when using the appliance. Floors adjacent to the appliance may become slippery.
- If the appliance is installed on casters, freedom of movement of the appliance must be restricted so that utility connections (including gas, water, and electricity) cannot be damaged when the appliance is moved. If the appliance is moved, make sure that all utility connections are properly disconnected. If the appliance is returned to its original position, make sure that any retention devices and utility connections are properly connected.

*Continued on next page*

*Continued from previous page*

- Do not cover or block any of the openings of this appliance.
- Do not cover racks or any other part of this appliance with metal foil.
- Do not keep anything underneath the oven that could block the vents.
- Do not use this appliance near water such as a sink, in a wet location, near a swimming pool, or similar locations.

## Maintenance precautions

Obey these maintenance precautions when maintaining the appliance:

- Obey precautions in the manual, on tags, and on labels attached to or shipped with the appliance.
- Only clean the exterior of the appliance when oven is OFF.
- Do not store the appliance outdoors.
- Do not clean the appliance with metal scouring pads.
- Do not use corrosive chemicals when cleaning the appliance.
- Do not use a hose, water jet, or steam cleaner to clean the appliance.
- Do not use the appliance cavity for storage.
- Do not leave flammable materials, cooking utensils, or food inside the appliance when it is not in use.
- Do not remove the top cover or side panels. There are no user-serviceable components inside.

## Operator training

Before using the appliance:

- Read and understand the operating instructions contained in all the documentation delivered with the appliance.
- Know the location and proper use of all controls.
- Keep this manual and all supplied instructions, diagrams, schematics, parts lists, notices, and labels with the appliance if the appliance is sold or moved to another location.
- Contact Alto-Shaam for additional training if needed.

## Operator qualifications

Only trained personnel are permitted to use the appliance. They must meet the following qualifications:

- Have received proper instruction on how to use the appliance
- Are familiar with commercial kitchens and commercial appliances

The appliance must not be used by:

- Persons (including children) with reduced physical, sensory or mental capabilities, or lack of experience and knowledge, unless they have been given supervision concerning use of the appliance by person responsible for their safety.
- People impaired by drugs or alcohol.

*Continued on next page*

*Continued from previous page*

- Children should be supervised to ensure that they do not play with the appliance.
  - Children shall neither clean nor maintain the appliance.
- 

### **Condition of appliance**

Only use the appliance when:

- All controls operate correctly
  - The appliance is installed correctly
  - The appliance is clean
  - The appliance labels are legible
- 

### **Servicing the appliance**

- Only trained personnel are permitted to service or repair the appliance. Repairs that are not performed by an authorized service partner or trained technician, or the use of non-factory parts, will void the warranty and relieve Alto-Shaam of all liability.
  - To prevent serious injury, death or property damage, have the appliance inspected and serviced at least every twelve (12) months by an authorized service partner or trained technician.
  - Contact Alto-Shaam for the authorized service partner in your area.
- 

### **Noise emissions**

- Without hood system, a maximum 67 dB(A) was measured at 3.3 ft (1m) from unit.
  - With hood system, a maximum 73 dB(A) was measured at 3.3 ft (1m) from unit.
- 

### **Massachusetts compliance**

In accordance with NFPA 54 for the Commonwealth of Massachusetts only: Where automatically operated appliances are vented through a ventilation hood or exhaust system equipped with a damper or with a power means of exhaust, provisions shall be made to allow the flow of gas to the main burners only when the damper is open to a position to properly vent the appliance and when the power means of exhaust is in operation.

---

### **Personal Protective Equipment (PPE)**

Wear the following Personal Protective Equipment (PPE) while cleaning the appliance:

- Protective gloves
  - Protective clothing
  - Eye protection
  - Face protection
- 

*Continued on next page*

Continued from previous page



**DANGER:** Before starting the oven, make sure you do not detect the odor of gas.

If you smell gas:

- Shut off the gas supply immediately.
- Do not attempt to light any appliance.
- Do not touch any electrical elements.
- Extinguish any open flame.
- Evacuate the area.
- Use a telephone outside of the property and immediately contact your gas supplier.
- If unable to contact your supplier, contact the fire department.

**NOTICE**



For equipment delivered for use in any location regulated by the following directive:  
2012/19/EU WEEE

Do not dispose of electrical or electronic equipment with other municipal waste.



# Labels

	<p>Made in U.S.A.</p>
	<p>WARNING Hot surface</p>
	<p>WARNING Electrical shock hazard</p>
	<p>Security seal</p>
	<p>WARNING Burn hazard Always load liquids, or foods that can become liquid when heated, at an eye level where they can be seen.</p>
	<p>Every Alto-Shaam product is precision calibrated prior to release from the factory to ensure accurate temperature control.</p>
 <p>LA-36443-E</p>	<p>Equipotential terminal</p>

LABELS

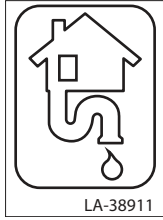

Drain water connection point.



Untreated, drinkable water connection point.

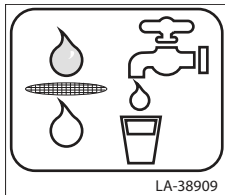

Treated, drinkable water connection point.

	Σ kg max.	Σ liter max.	Σ GN 1/1
6-10	33	57	7
10-10	54	95	11
7-20	76	133	16
10-20	109	190	22
20-10	109	190	20
20-20	218	380	40

LA-48238

Capacities

**WARNING/ADVERTENCIA/AVERTISSEMENT**

**Fire Hazard**  
This appliance is only for use with factory-supplied legs, casters, or base.

**Peligro de incendio**  
Este aparato solo se puede usar con patas, ruedas o base proporcionadas por la fábrica.

**Risque d'incendie**  
Ce appareil est destiné à être utilisé uniquement avec les pieds, les roulettes ou le socle fournis par le fabricant.

LA-39336

WARNING

Fire hazard

This oven is only for use with factory-supplied legs, casters, or base.

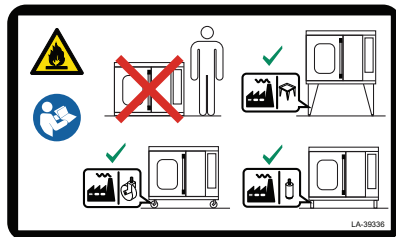



WARNING

Steam. Open door carefully.

		<p><b>WARNING ADVERTENCIA AVERTISSEMENT</b></p>
 	<p>Failure to follow cleaning instructions can cause injury or equipment damage. Clean oven only with Alto-Shaam concentrated cleaning tablets. Cleaner is caustic. Avoid contact with skin or eyes. Wear PPE. Read and understand the safety data sheet and the operator's manual before cleaning.</p> <p>Si no se siguen las instrucciones de limpieza, puede sufrir lesiones o daños en el equipo. Limpie el horno solo con las pastillas de limpieza concentradas de Alto-Shaam. El limpiador es cáustico. Evite el contacto con la piel o los ojos. Use equipo de protección personal (Personal Protective Equipment, PPE). Lea completamente la hoja de datos de seguridad y el manual del operador antes de realizar la limpieza.</p> <p>Pour écarter les risques de blessures ou de dégâts matériels, veiller à respecter les instructions de nettoyage. Nettoyer le four uniquement avec les pastilles nettoyantes concentrées Alto-Shaam. Le produit nettoyant est caustique. Éviter le contact avec la peau et les yeux. Porter un EPI. Lire et comprendre la fiche de données de sécurité et le manuel de l'utilisateur avant de nettoyer.</p>	
<p>LA-22836</p>		

WARNING

Failure to follow cleaning instructions can cause injury or equipment damage. Clean oven only with Alto-Shaam concentrated cleaning tablets. Cleaner is caustic. Avoid contact with skin or eyes. Wear PPE. Read and understand the safety data sheet and the operator's manual before cleaning.

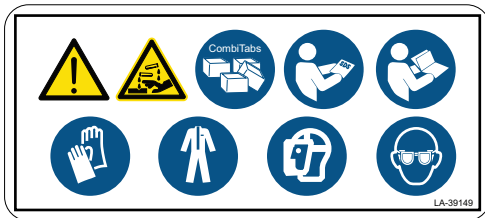

	<p><b>WARNING/ADVERTENCIA/AVERTISSEMENT</b></p>
	<p><b>Electric Shock Hazard</b> Appliances with permanent electrical connection that are mounted on casters must be secured to building structure. Read installation instructions.</p> <p><b>Peligro de descarga eléctrica</b> Los equipos con una conexión eléctrica permanente que estén montados sobre ruedas deben estar fijos a la estructura del edificio. Lea las instrucciones de instalación.</p> <p><b>Risque d'électrocution</b> Les appareils à branchement électrique fixe qui sont montés sur roulettes doivent être attachés à la structure du bâtiment. Lire les instructions d'installation.</p>
<p>LA-38912</p>	

WARNING

Electric shock hazard

Appliances with permanent electrical connections that are mounted on casters must be secured to building structure. Read installation instructions.

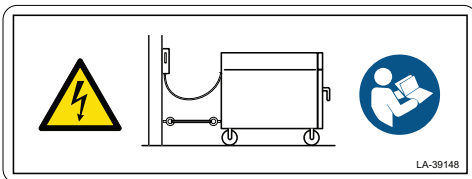

**WARNING/ADVERTENCIA/AVERTISSEMENT**

**WARNING:**  
Improper installation, adjustment, alteration, service or maintenance can cause property damage, injury or death. Read the installation, operating and maintenance instructions thoroughly before installing or servicing the equipment.

Water and waste connection shall comply with the basic plumbing code of the Building Officials and Code Administrators International, Inc. (BOCA) and the Food Service Sanitation Manual of the Food and Drug Administration (FDA).

**ADVERTENCIA:**  
Una instalación, ajuste, modificación, reparación o mantenimiento inadecuado podría producir daños en el equipo, lesiones personales e incluso la muerte. Lea las instrucciones de instalación, funcionamiento y mantenimiento detenidamente antes de instalar o reparar el equipo.

La conexión de agua y de aguas residuales debe cumplir el Código de Tuberías Básico (Basic Plumbing Code) de Building Officials and Code Administrators International, Inc. (BOCA), y el Manual de Sanidad de Servicio de Alimentos (Food Service Sanitation Manual) de la Administración de Drogas y Alimentos (FDA, por sus siglas en inglés).

**AVERTISSEMENT:**  
L'installation, le réglage, la modification, la réparation ou l'entretien incorrect de cet appareil peut causer des dommages matériels, des blessures ou la mort. Lire attentivement les instructions d'installation, de fonctionnement et d'entretien avant de procéder à son installation ou entretien.

Le raccordement d'eau et d'évacuation doit être conforme au Basic Plumbing Code de BOCA (Building Officials and Code Administrators International, Inc.) et au Food Service Sanitation Manual de la FDA (Food and Drug Administration).

LA-38905

WARNING

Improper installation, adjustment, alteration, service or maintenance can cause property damage, injury or death. Read the installation, operating and maintenance instructions thoroughly before installing or servicing the equipment. Water and waste connection shall comply with the basic plumbing code of the Building Officials and Code Administrators International, Inc. (COCA) and the Food Service Sanitation Manual of the Food and Drug Administration (FDA).

**WARNING/ADVERTENCIA/AVERTISSEMENT**

**Fire Hazard**  
For use only on noncombustible surfaces. Maintain the correct clearances to combustibles.

**Peligro de incendio**  
Solo para uso en superficies no combustibles. Mantenga las distancias correctas de elementos combustibles.

**Risque d'incendie**  
Utilisation sur des surfaces non combustibles seulement. Maintenir des dégagements corrects par rapport aux matières combustibles.

	Combustibles	Non-combustibles
Top/tepe/haut	20" (508mm)	20" (508mm)
Left/izquierda/gauche	0" (0mm)	0" (0mm)
Right/derecho/droite	2" (51mm)	0" (0mm)
Rear/posterior/arrière	4" (102mm)	4" (102mm)

LA-38906

WARNING

Fire hazard

For use only on noncombustible surfaces. Maintain the correct clearances to combustibles.

LA-38907

**COA #5760**

LA-39312

Certificate of Approval number, Fire Department - City of New York.

**NOTICE/AVISO/AVIS**

For trained personnel only: The installation manual and the wiring diagram for this appliance can be found inside the oven attached to the opposite side of this panel.

Solo para personal capacitado: El manual de instalación y el diagrama de cableado de este equipo se pueden encontrar dentro del horno, en el lado opuesto de este panel.

Personnel formé seulement : Le manuel d'installation et le schéma de câblage de cet appareil se trouvent à l'intérieur du four attachés de l'autre côté de ce panneau.

LA-38941

**NOTICE**

For trained personnel only: The installation manual and the wiring diagram for this appliance can be found inside the oven attached to the opposite side of this panel.

**WARNING/ADVERTENCIA/AVERTISSEMENT**

 **Electric Shock Hazard**  
To reduce the risk of electric shock, do not remove or open cover. No user-serviceable parts inside. Refer servicing to qualified personnel.  
Qualified personnel: Disconnect power before servicing.

**Peligro de descarga eléctrica**  
Para reducir el riesgo de descarga eléctrica, no retire ni abra la cubierta. No hay piezas en el interior a la que se les pueda realizar mantenimiento. Derive el mantenimiento a personal calificado.  
Personal calificado: Desconecte la energía antes de realizar mantenimiento.

**Danger de décharge électrique**  
Pour réduire le risque de décharge électrique, ne par ouvrir ni retirer le capot. Ne contient pas de pièces réparables par l'utilisateur. Confier les réparations à du personnel qualifié.  
Personnel qualifié : Sectionnez l'alimentation avant toute intervention.

LA-38950

**WARNING**

Electric shock hazard

To reduce the risk of electric shock, do not remove or open cover. No user-serviceable parts inside. Refer servicing to qualified personnel.

Qualified personnel: Disconnect power before servicing.



Use \_\_\_\_\_ AWG for supply connections.  
Use only copper wires suitable for temperatures  $\geq 90^{\circ}\text{C}$ .  
Do not connect to a circuit operating at more than 150 VAC to ground.  
For use on individual branch circuits only.

 **AWG 90°C**

Use AWG \_\_\_\_\_ para las conexiones de suministro.  
Use solo cables de cobre aptos para temperaturas mayores que  $90^{\circ}\text{C}$ .  
No conecte a un circuito que funcione a más de 150 V CA a tierra.  
Para su uso en circuitos derivados individuales solamente.

Utiliser du calibre \_\_\_\_\_ AWG pour les raccordements électriques.  
Utiliser exclusivement des conducteurs en cuivre qui conviennent à des températures  $\geq 90^{\circ}\text{C}$ .  
Ne pas raccorder à un circuit fonctionnant sous plus de 150 VCA par rapport à la terre.  
Utiliser exclusivement sur des circuits de dérivation propres.

LA-38852

**Note:** This label is only used on UL-certified appliances that have 120V to ground wiring.

Use \_\_\_\_\_ AWG for supply connections.

Use only copper wires suitable for temperature less than or equal to  $90^{\circ}\text{C}$ .

Do not connect to a circuit operating at more than 150 VAC to ground.

For use on individual branch circuits only.

**NOTICE:** In order to be able to service this appliance, it must be installed with the casters supplied, a connector complying with ANSI Z21.69 — CSA 6.16 and a quick-disconnect device complying with ANSI Z21.41 — CSA 6.9. It must also be installed with the restraining means to guard against transmission of strain to the connector as specified in the appliance manufacturer's instructions.

**AVIS:** Pouvoir être entretenu, cet appareil doit être équipé des roulettes fournies, d'un connecteur conforme à la norme ANSI Z21.69 • CSA 6.16 et d'un connecteur à branchement rapide conforme à la norme ANSI Z21.41 • CSA 6.9. Il doit aussi comporter un dispositif empêchant que la traction soit transmise au connecteur, comme il est spécifié dans les instructions du fabricant.

**AUFSTELLUNG:** Gasanschluß und Inbetriebnahme dürfen nur durch autorisiertes Fachpersonal entsprechend der gültigen örtlichen Sicherheitsbestimmungen durchgeführt werden. Gasbetriebene Geräte dürfen nur dann beweglich aufgestellt, angeschlossen und in Betrieb genommen werden, wenn der Gasanschluß mit einer flexiblen Schlauchverbindung mit Schnellverschluß hergestellt wird und das Gerät mittels einer Vorrichtung (z.B. mit der Wand verankerte Kette) gegen unbeabsichtigtes Verschieben gesichert ist. Für die bewegliche Aufstellung sind ausschließlich die mitgelieferten Räder an den Geräten zu montieren.

**AVISO:** Para poder mantener esta aplicación, debe ser instalado con los ruedas provistos, con un conector homologado según el estándar ANSI Z21.69 o CSA 6.16 y con un dispositivo de desconexión rápida que cumpla con el estándar ANSI Z21.41 o CSA 6.9. También deberá instalarse un sistema de sujeción para evitar tensiones en el conector, procediendo según se indica en las instrucciones del fabricante del equipo.

注意——为了方便检修设备，必须安装设备自带的脚轮装置、一个符合ANSI Z21.69- CSA 6.16标准的连接器和一个符合ANSI Z21.41- CSA 6.9标准的快速断开装置。设备制造商说明书中明确规定，安装该脚轮时，必须采取防护措施，以避免移动设备时的拉力损坏脚轮。

LA-25784

**NOTICE:** Use only factory-supplied casters when needed. When this appliance includes casters, the following must also be installed:

- a connector complying with ANSI Z21.69 / CSA 6.16;
- a quick-disconnect device complying with ANSI Z21.41 / CSA 6.9;
- a restraining device to guard against transmission of strain to the connector as specified in the manual.

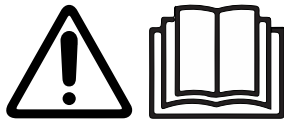

Consult instructions for operation and use.

USA This appliance shall be installed in conformity with the local regulations and used only in well ventilated locations. Consult the instruction manual before installing this appliance.

CN: China 该仪器必须按照有关规定进行安装，并放置在通风的地方。安装使用该仪器前，请参考说明书。

DE: Germany Das Gerät muss nach Lokalen Richtlinien installiert werden. Es kann nur in gut gelüfteten Bereichen verwendet werden. Siehe Gebrauchsanweisung vor dem Installieren des Gerätes.

DK: Denmark Dette apparat skal installeres i overensstemmelse med de lokale vedtægter og må kun bruges på et sted med ordentlig ventilation. Læs instruktionerne inden du installerer dette apparat.

ES: Spain Este equipo se debe instalar en conformidad con las normas locales y se debe usar sólo en lugares bien ventilado. Consulte las instrucciones antes de instalar este equipo.

FI: Finland Tämä laite on asennettava paikallisia määräyksiä noudattaen, ja sitä saa käyttää ainoastaan tiloissa, joissa on hyvä ilmanvaihto. Tutustu käyttöoppaaseen ennen laitteen asentamista.

FR: France Cet appareil doit être installé dans un espace bien aéré en conformité avec la réglementation en vigueur. Consultez le manuel d'instructions avant d'installer l'appareil.

GB: Britain This appliance shall be installed in conformity with the local regulations and used only in well ventilated locations. Consult the instruction manual before installing this appliance.

GR: Greece Η εγκατάσταση της συσκευής πρέπει να γίνει σε συμμόρφωση προς τους τοπικούς κανονισμούς και η χρήση της επιτρέπεται μόνο σε χώρους με καλό εξαερισμό. Προτού εγκαταστήσετε τη συσκευή, συμβουλευτείτε το εγχειρίδιο οδηγιών.

HU: Hungary Ezt a készüléket a helyi szabványoknak megfelelően kell telepíteni, és csak jól szellőző helyeken szabad használni. A készülék telepítése előtt tanulmányozza a használati útmutatót.

IT: Italy Questo apparecchio deve essere installato in conformità della normativa locale e solo in aree ben ventilate. Prima di installare l'apparecchio, consultare il manuale delle istruzioni.

NL: Netherlands Dit apparaat dient te worden geïnstalleerd conform de plaatselijke regelgeving en mag alleen gebruikt worden in goed geventileerde ruimten. Raadpleeg de handleiding voor u dit apparaat installeert.

PL: Poland Urządzenie należy instalować zgodnie z lokalnymi przepisami i używać wyłącznie w pomieszczeniach z dobrą wentylacją. Przed zainstalowaniem urządzenia należy zapoznać się z instrukcją obsługi.

PT: Portugal Este aparelho deverá ser instalado de acordo com os regulamentos locais e usado apenas em locais bem ventilados. Consulte o manual de instruções antes de instalar o aparelho.

RO: Romania Acesta aparat va fi instalat în conformitate cu reglementările locale și va fi folosit doar în spații bine ventilate. Consultați manualul cu instrucțiuni înainte de instalarea aparatului.

RU: Russia Этот прибор должен быть установлен в соответствии с местными нормативами и использоваться только в хорошо вентилируемом помещении. Прежде чем устанавливать этот прибор, изучите инструкцию по эксплуатации.

SE: Sweden Denna produkt ska installeras i enlighet med lokala föreskrifter och enbart användas i väl ventilerade utrymmen. Läs bruksanvisningen innan produkten installeras.

SI: Slovenia Napravo je treba namestiti skladno z lokalnimi predpisi in v gorajljati le v dobro prezračenih prostorih. Pred namestitvijo glejte navodila za uporabo.

TR: Turkey Bu ekipmanın kurulumu yerel düzenlemelere uygun olarak yapılmalı ve ekipman iyi havalandırılmış ortamlarda kullanılmalıdır. Ekipmanın kurulumuna başlamadan önce kullanım kılavuzunu inceleyin.

NATURAL	Cat	Gas Type
DK/EE/PT/GR/HU/IS/IT/NO	I2H3B/P	2H-G20-20mba r
RO/SE/SK/CY/PL/TR	I2H3B/P	2H-G20-20mba r
ES/FR/GB/IE/PT/US/CZ	I2H3P	2H-G20-20mba r
AT/CH	I2H3B/P	2H-G20-20mba r
BE	I2E03B/P	2H-G20-20mba r
DE	I2ELL3B/P	2E-G20-20mba r
PROPANE	Cat	Gas Type
DK/EE/PT/GR/HU/IS/IT/NO	I2H3B/P	3B/P-G30/G31-30mba r
RO/SE/SK/CY/PL/TR	I2H3B/P	3B/P-G30/G31-30mba r
ES/FR/GB/IE/PT/US/CZ	I2H3P	3P-G31-30mba r
AT/CH	I2H3B/P	3B/P-G30/G31-50mba r
BE	I2E03B/P	1P-G31-30mba r
DE	I2ELL3B/P	3B/P-G30/G31-50mba r
NL	I2L3B/P	3B/P-G30/G31-30mba r
IL	I2L3B/P	2I-G25-25mba r
AUS/NZ		NGN 1.0kPa
AUS/NZ		1PG-X Propane 2.75 kPa
Japan		Natural Gas 1.2k kPa
Japan		LPG - Propane 2.8 kPa

LA-36742

This appliance shall be installed in conformity with the local regulations and used only in well ventilated locations. Consult the instruction manual before installing this appliance.

UNIT READY FOR NATURAL GAS  
 该设备可以使用天然气  
 LA-23732

Unit ready for natural gas.

UNIT READY FOR PROPANE GAS  
 设备可使用液化石油气  
 LA-23733

Unit ready for propane gas.

This page is intentionally left blank.



# How to Turn On and Turn Off the Oven

## Before you begin

- The oven must be connected to electric power.
- Make sure the gas supply is connected.
- Make sure the water supply is connected.

## Turning on the oven

To turn on the oven, do the following.

Step	Action
1.	<b>Touch</b> the ON/OFF button ①.

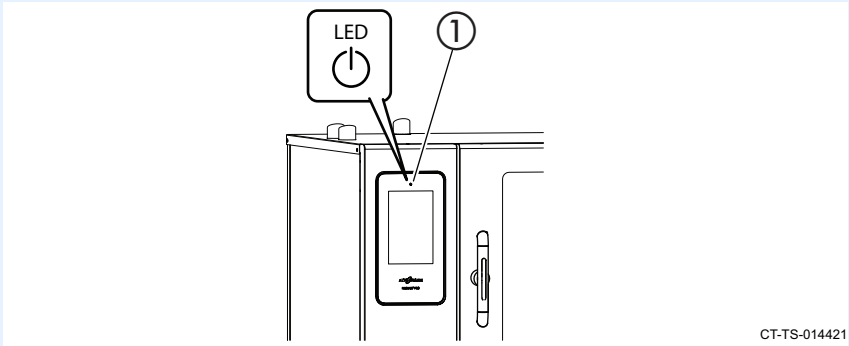

CT-TS-014421

The oven is now on.

## Turning off the oven

To turn off the oven, do the following.

2. **Touch** and hold the ON/OFF button ① until the “Shut Down Options” screen displays. **Touch** “Shut down” ②.

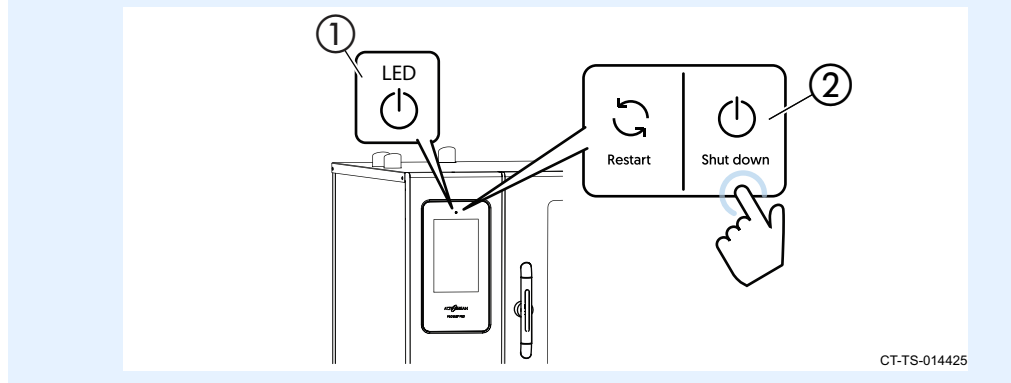





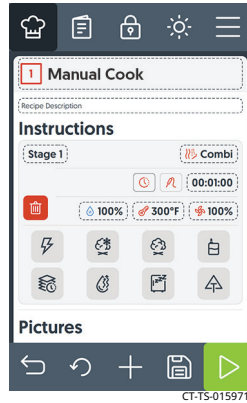











The oven is now off.

# Icon Identification



Icon	Icon name	Description
	Manual cook	Touch to use manual cook mode.
	Recipe book	Touch to browse recipes.
	Lock	Touch to lock the control.
	Lights	Touch to turn on or turn off the cavity lights.
	Menu	Touch to view the control menu.
	Professional cook	Touch to use professional cook mode.
	Preheat	Touch to set a preheat temperature.
	Cool down	Touch to set a cool down temperature.
	Back arrow	Touch to return to the previous screen.

	Convection	Touch to select convection mode.
	Combi	Touch to select combi mode.
	Steam	Touch to select steam mode.
	Action	Touch to select an action step or touch to continue during the cooking process.
	Cook time	Touch to cook by time.
	Probe	Touch to cook by probe.
	Humidity	Touch to set the humidity percentage.
	Temperature	Touch to set the temperature.
	Fan speed	Touch to set the fan speed.
	Power level	Touch to select the power level.
	Cold smoke	Touch to cold smoke.
	Hot smoke	Touch to hot smoke.
	Grease collection	Touch to turn on or turn off grease collection.
	Multiple shelves	Touch to cook using multiple shelf timers.

	Dehydrate	Touch to use dehydrate mode.
	Rest	Touch to use resting mode.
	Delta-T	Touch to use Delta-T mode.
	Reset	Touch to reset the chamber.
	Plus	Touch to add stage or action.
	Recipe edit icon	Touch to edit a recipe.
	Save	Touch to save a recipe.
	Duplicate	Touch to duplicate a recipe.
	Start	Touch to start a cook.
	Cancel	Touch to cancel a cook.

# How to View and Set up WiFi Connection

## Before you begin

- The facility must have WiFi.
- Do not connect to a guest network.

## Procedure

To set up WiFi, do the following.

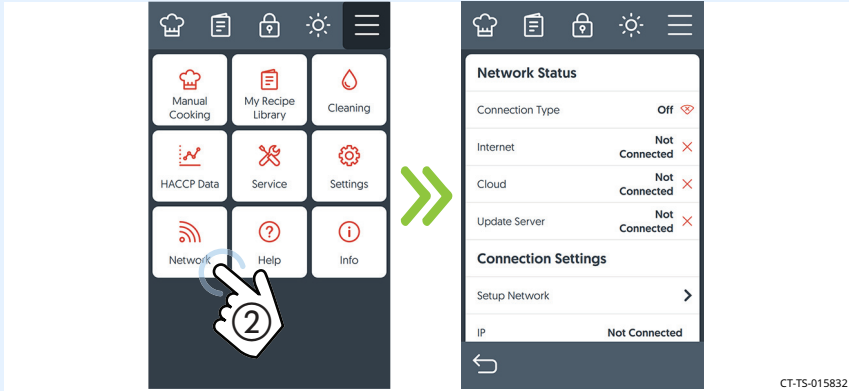
Step	Action
1.	<p><b>Touch</b> the menu icon ①. The menu screen displays.</p>  <p>CT-TS-014429</p>
2.	<p><b>Touch</b> the “Network” icon ②. The “Network Status” screen displays.</p>  <p>CT-TS-015832</p>

*Continued on next page*

Continued from previous page

3. **Touch** the “Setup Network” setting ③.

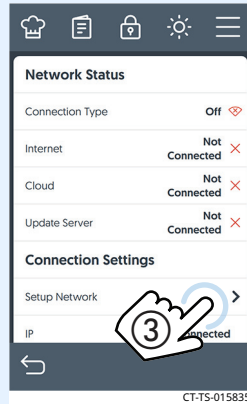

CT-TS-015835

4. **Touch** the “WiFi” icon ④.

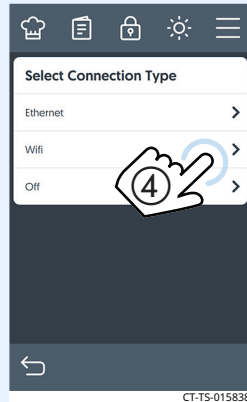

CT-TS-015838

The available networks will show on the screen. The color of the network icon indicates the strength of the signal for each network.

- Green = strong
- Yellow = medium
- Red = weak

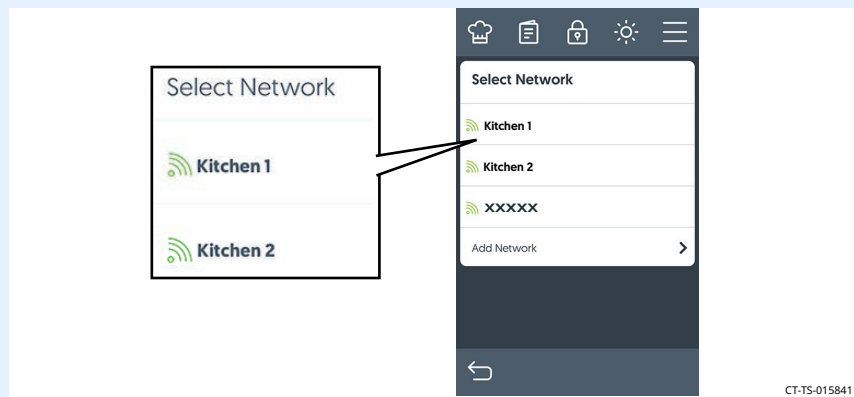

CT-TS-015841

Continued on next page

Continued from previous page

5. If the network is not displayed, **touch** the “Add Network” setting ⑤.

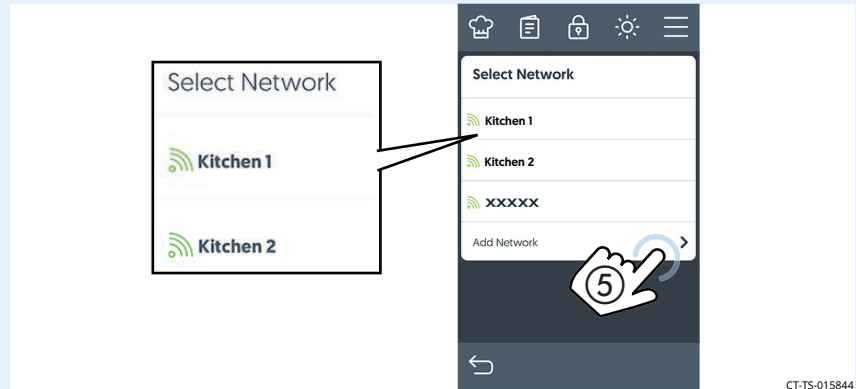

**Enter** the SSID using the keypad. Then, **touch** the check mark.

**Select** the security type.

**Enter** the password using the keypad. Then, **touch** the check mark.

**Touch** the check mark when finished.

## Result

The procedure is now complete.

# ChefLinc Installation Checklist

Place this form with the oven's records.

## Connectivity Pre-Installation Checklist

Will you connect the oven to the Internet using Wi-Fi or Ethernet?	Wi-Fi	Ethernet	Unable to answer
--	-------	----------	------------------

## Wi-Fi Connections

Is the Wi-Fi network that is to be used a WPA2 secured network?	Yes	No	Unable to answer
Is this network also used to send and receive point of sale information (credit card data, register receipts)? This is NOT recommended for any installation.	Yes	No	Unable to answer
Have you been provided with the network name (SSID) for the oven to connect to?	Yes	No	Unable to answer
Have you been provided the password for the Wi-Fi network to be used?	Yes	No	Unable to answer
At the final location that the oven will be installed, can you connect to the Wi-Fi system with your phone?	Yes	No	Unable to answer
Using your phones Wi-Fi connection, are you able to connect to alto-shaam.com? You are testing for any additional security on the network to block access to external sites. You will need to turn off your cellular service on your phone to make sure you're using the Wi-Fi network.	Yes	No	Unable to answer

## Ethernet Connections

At the final location that the oven will be installed, is there an open Ethernet port conveniently located?	Yes	No	Unable to answer
Is the Ethernet port live (providing Internet access)?	Yes	No	Unable to answer
Is the Ethernet harness accessory ordered with the unit?	Yes	No	Unable to answer

Is there site action required?	Yes	No
Action required:		

*Continued on next page*



Continued from previous page

### Connectivity Installation Checklist

Refer to Network Status screen

What is your connection type?	Wi-Fi	Ethernet
What color is the network status icon?	Red    Yellow	Green
What is the Internet status?	Connected	Not connected
What is the cloud status?	Connected	Not connected
What is the update server status?	Connected	Not connected
What is the SSID (network name)?		
What is the password?		
What is the IP address?		
What is the Front End (FE) software version number?		
What is the Back End (BE) software version number?		
What is the Control Board (CB) software version number?		
Is this the latest software version?	Yes	No
Validate via: <a href="https://www.alto-shaam.com/en/customer-support/software-downloads">https://www.alto-shaam.com/en/customer-support/software-downloads</a>		

# How to Set up an Ethernet Connection

## Before you begin

- The facility must have an Ethernet port.
- You will need an Ethernet cable.

## Procedure

To set up an Ethernet connection, do the following.

Step	Action
------	--------

1. **Plug** the Ethernet cord into the Ethernet port on the oven and the wall outlet.

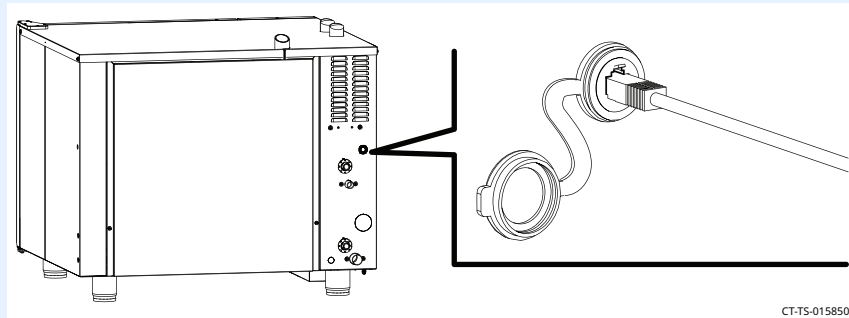

2. **Touch** the menu icon ①. The menu screen displays.



*Continued on next page*

Continued from previous page

3. **Touch** the “Network” icon ②. The “Network Status” screen displays.

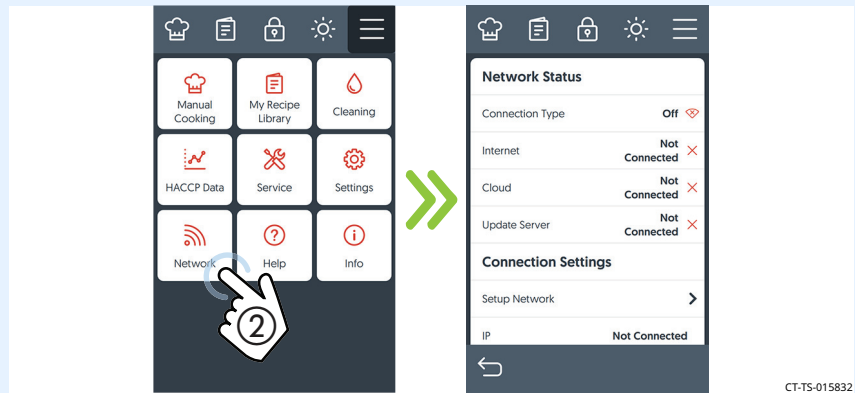

4. **Touch** the “Setup Network” setting ③.

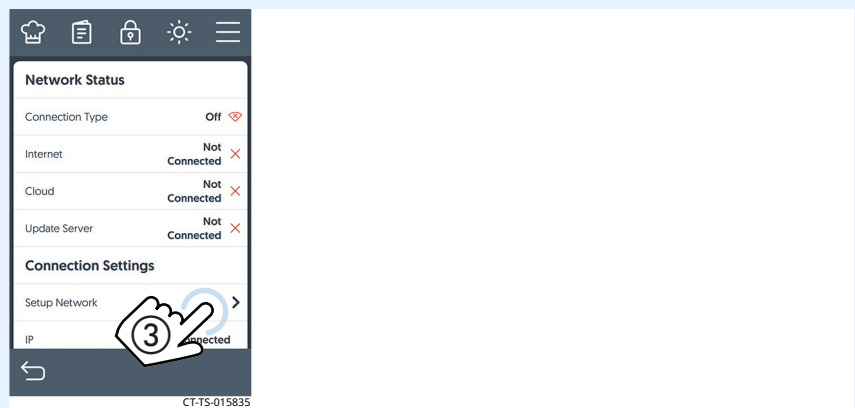

5. **Touch** the “Ethernet” setting ④. Follow any prompts.

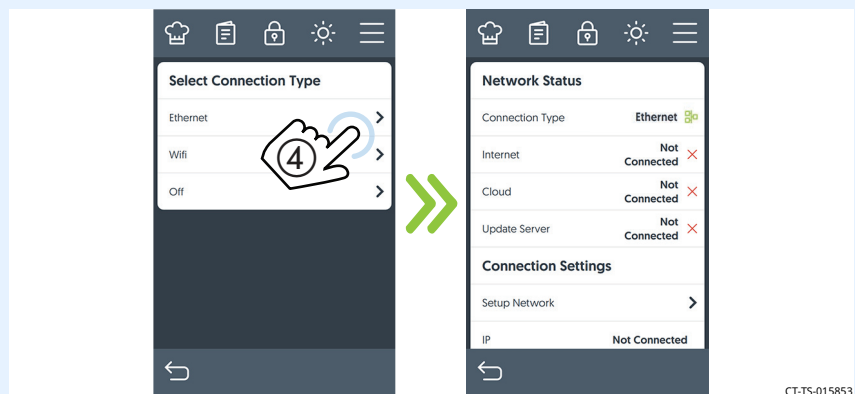

## Result

The Ethernet connection is now set up.

# How to Preheat the Oven

## Before you begin

### Make sure:

- The oven is turned on.
- The oven door is closed.

## Procedure

To preheat the oven, do the following.

Step	Action
1.	<p>From the manual cooking screen, <b>touch</b> the preheat icon ①.</p> <p><b>Enter</b> the preheat temperature using the number pad. <b>Touch</b> the check mark.</p>



CT-TS-015751

## Screen loading bars

The loading bar indicates the progress towards reaching the set temperature.

If necessary, touch the cancel icon ② to cancel the preheating process before the oven reaches its preheat temperature.

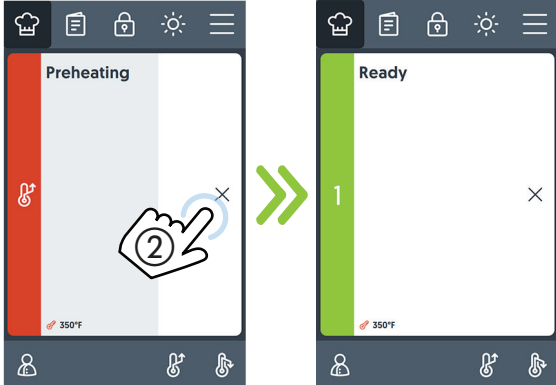

CT-TS-015754

## Result

The oven is preheating. When the preheat process is complete, the screen displays Ready.

# How to Cook with Programmed Recipes

## Before you begin

### Make sure:

- The oven is preheated.
- Your food is prepared and ready to cook.

## Procedure

To cook using a programmed recipe, do the following.

Step	Action
1.	<b>Touch</b> the recipe book icon ①. The browse recipes screen displays.
2.	<b>Navigate</b> to the recipe. <b>Open</b> the door and load the food into the cavity. <b>Close</b> the door. <b>Touch</b> the recipe photo ②. The cooking process starts.

1. **Touch** the recipe book icon ①. The browse recipes screen displays.

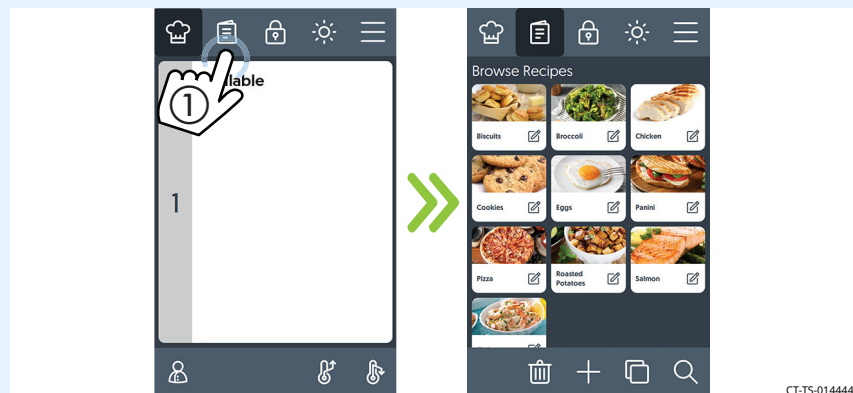

2. **Navigate** to the recipe.

**Open** the door and load the food into the cavity. **Close** the door.

**Touch** the recipe photo ②. The cooking process starts.

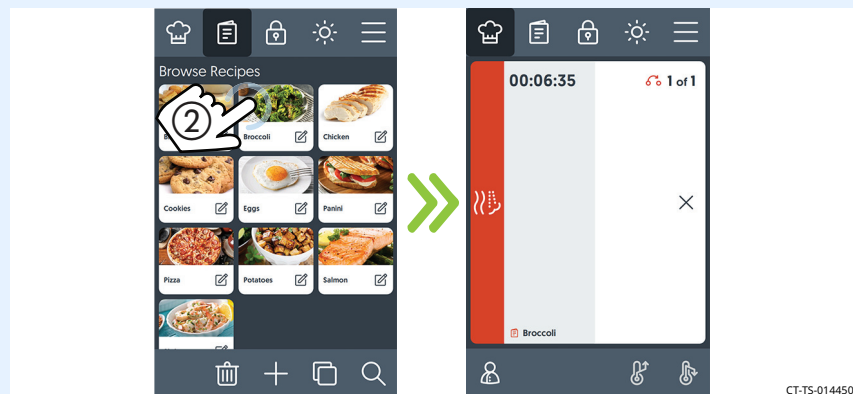

*Continued on next page*

*Continued from previous page*

**During the cooking process**

The cooking status screen displays the details on the current cook setting.  
 During the cooking process:

Action	Result
Touch the hand icon  when action is required...	to continue the cooking process.
Touch "X"...	to cancel the cooking process.

**Result**

At the end of the cooking process, the oven sounds an alert and both the cavity light and door handle light flash. Remove the cooked food.

# How to Cook in Manual Mode

## Before you begin

**Make sure** your food is prepared and ready to cook.

## Background

This procedure consists of:

- setting a preheat temperature;
- setting the food loading action;
- and setting the cooking stage parameters (temperature, time, humidity, and fan speed).

## Procedure

To cook in manual mode, do the following.

Step	Action
1.	<b>Touch</b> the manual cook icon ①. The manual cook screen displays.

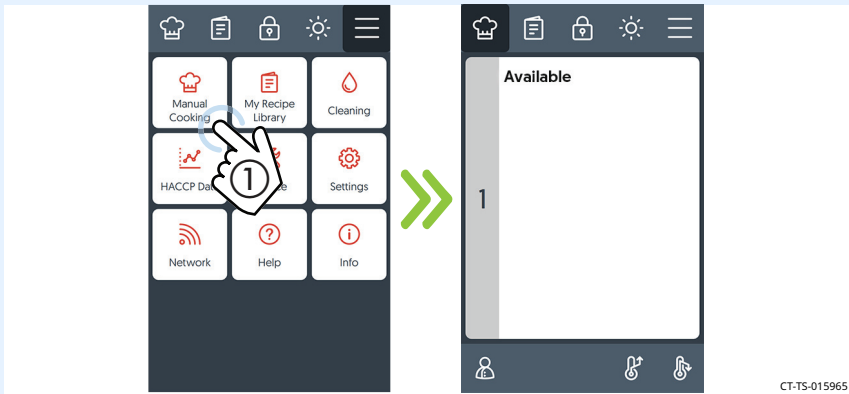

*Continued on next page*

Continued from previous page

2. **Touch** the cavity ②.

**Touch** preheat, a cooking mode or an action step icon ③ to choose the step type.

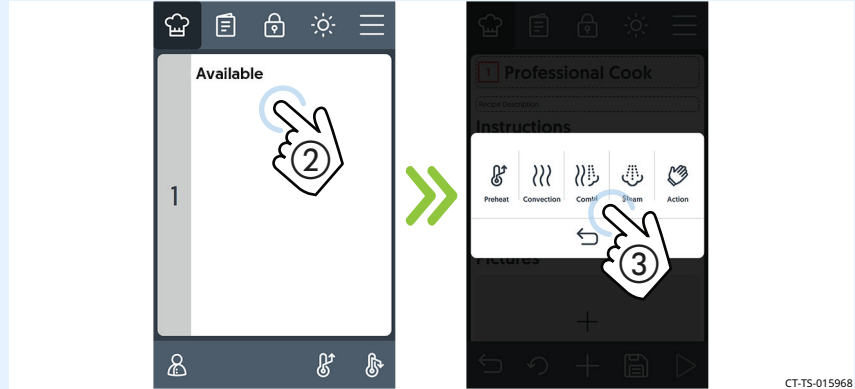

**NOTE:** Touching “Action” adds an action step to the recipe. An action adds manual tasks to be completed during the recipe such as loading the food or adding an ingredient.

3. The manual cook screen displays. The upcoming steps set the parameters for this screen.

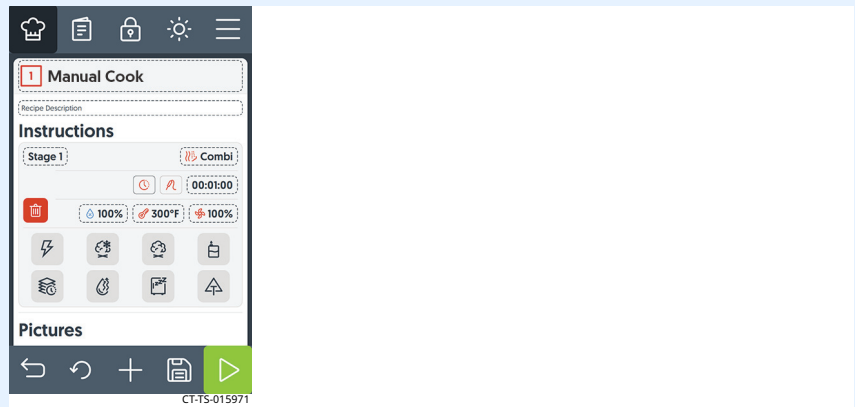

Continued on next page



Continued from previous page

**Cooking by time**

4. If cooking by time, **touch** the cook by time icon ④. Then, **touch** the cooking time ⑤. **Enter** the cooking time using the key pad. **Touch** the check mark.

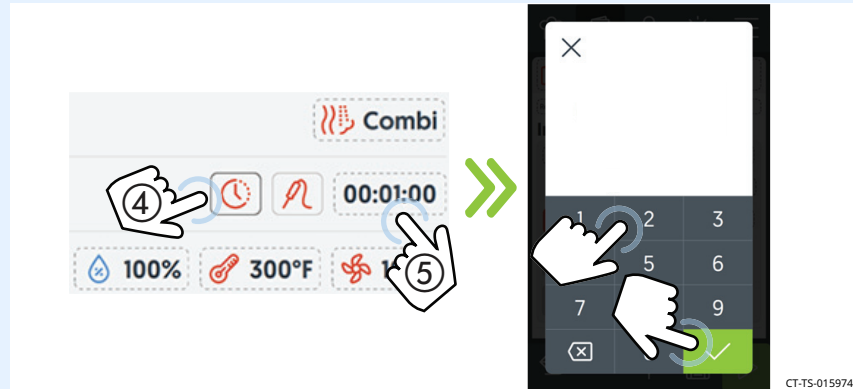
**Cooking by probe**

5. If cooking by probe, **touch** the cook by probe icon ⑥. Then, **touch** the probe temperature ⑦. **Enter** the probe temperature set-point using the key pad. **Touch** the check mark.

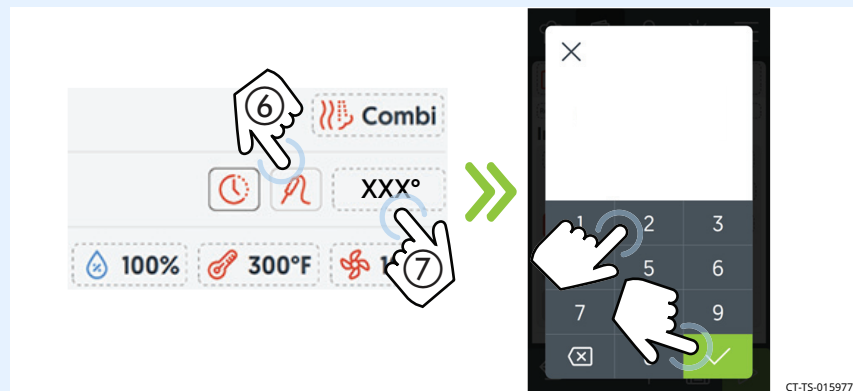

Continued on next page

Continued from previous page

6. **Touch** the cooking temperature icon ⑧. **Enter** the cooking temperature using the key pad.

**Touch** the humidity percentage icon ⑨. **Enter** the humidity percentage using the key pad.

**Touch** the fan speed icon ⑩. **Select** the fan speed.

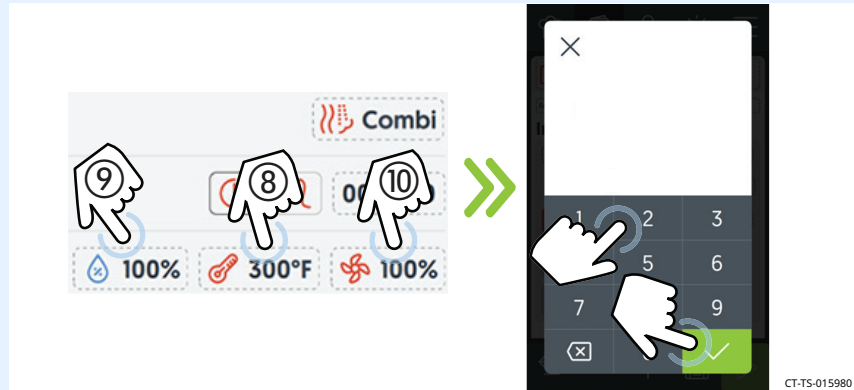

CT-TS-015980

7. **Touch** the plus (+) icon to add an additional step or action, if needed.

8. **Load** the food into the oven.

9. **Touch** the start icon ⑪. The cooking process timer starts to count down.

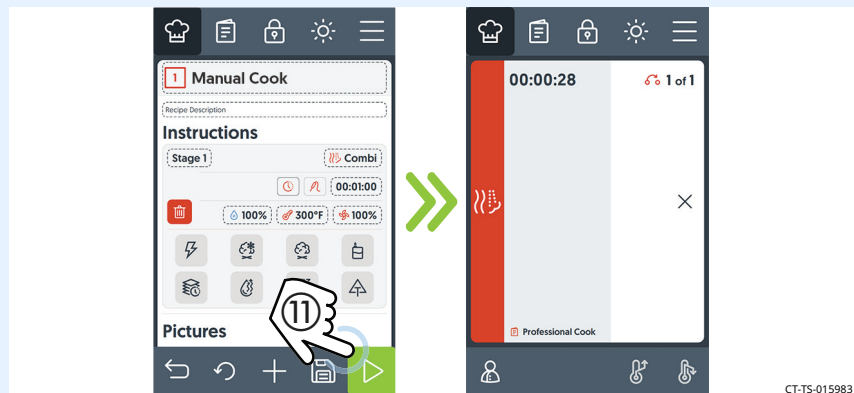

CT-TS-015983

Continued on next page

Continued from previous page

## During the cooking process

Action	Result
Touch the hand icon  when action is required...	to continue the cooking process.
Touch the chamber...	to show the recipe details.
Touch "X"...	to cancel the cooking process.

10. At the end of the cooking process, the oven sounds an alert, and the cavity light and door handle light flash.

11. **Open** the door and remove the hot food.



**NOTE:** Be sure to remove the cooked food after the cooking process is complete. If left inside the oven, the food will continue to cook.

## Result

The food is now cooked.

# How to Cook in Professional Mode

## Before you begin

### Make sure:

- The oven is preheated.
- Your food is prepared and ready to cook.

## Background

This procedure consists of:

- setting the food loading action;
- and setting the cooking stage parameters (temperature, time, humidity, and fan speed).

## Procedure

To cook in professional mode, do the following.

Step	Action						
1.	<p><b>Touch</b> the professional cook icon ①. The professional cook screen displays.</p>						
2.	<p><b>Select</b> a cooking mode ②.</p> <table border="1" data-bbox="1047 1444 1356 1606"> <tbody> <tr> <td></td> <td>Convection mode</td> </tr> <tr> <td></td> <td>Combi mode</td> </tr> <tr> <td></td> <td>Steam mode</td> </tr> </tbody> </table>		Convection mode		Combi mode		Steam mode
	Convection mode						
	Combi mode						
	Steam mode						

*Continued on next page*

Continued from previous page

3. **Touch** the cooking temperature icon ③. **Enter** the cooking temperature using the key pad.

**Touch** the fan speed icon ④. **Select** the fan speed.

**Touch** the humidity percentage icon ⑤. **Enter** the humidity percentage using the key pad.

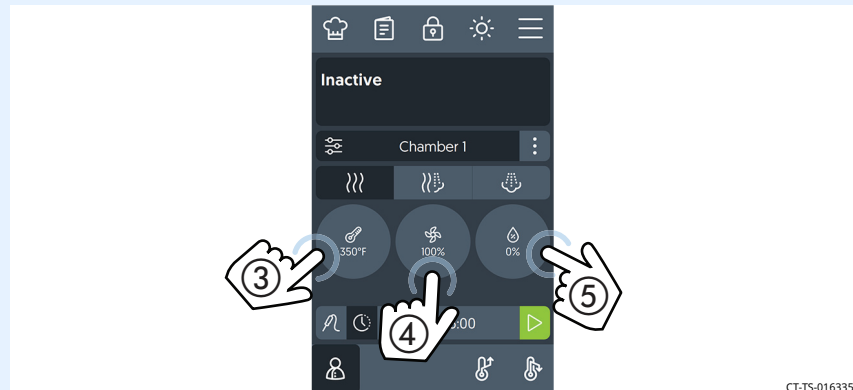

CT-TS-016335

4. If cooking by time, **touch** the cook by time icon ⑥. Then, **touch** the cooking time ⑦. **Enter** the cooking time using the key pad. **Touch** the check mark.



CT-TS-016338

Continued on next page

Continued from previous page

**Cooking by probe**

5. If cooking by probe, **touch** the cook by probe icon (8). Then, **touch** the probe temperature (9). **Enter** the probe temperature set-point using the key pad. **Touch** the check mark.

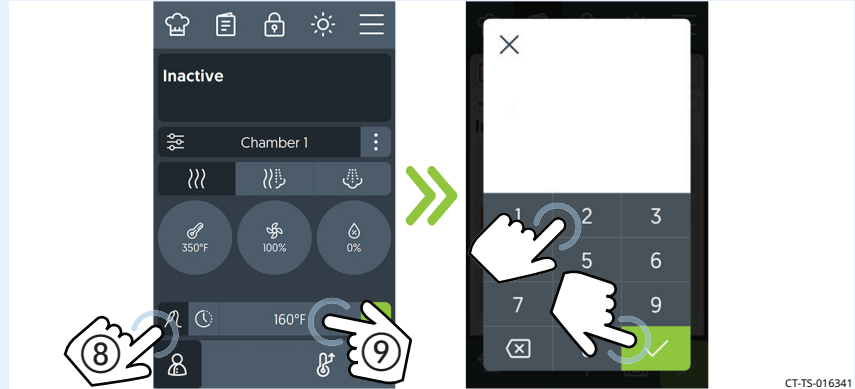

CT-TS-016341

6. **Load** the food into the appropriate chamber.
7. **Touch** the start icon (10). The cooking process timer starts to count down.

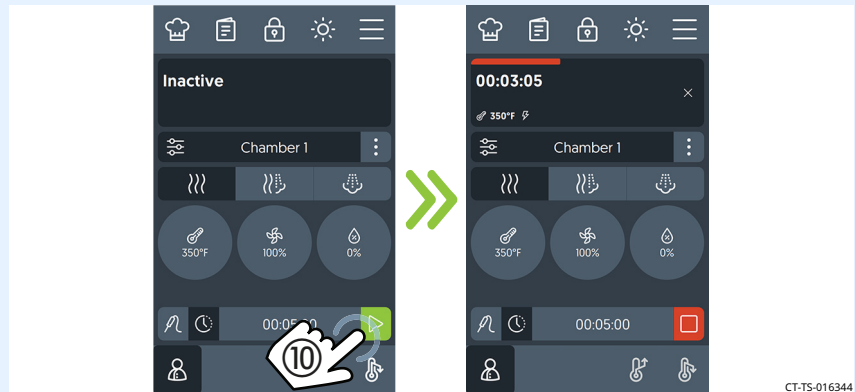

CT-TS-016344

Continued on next page

Continued from previous page

## During the cooking process

Action	Result
Touch the hand icon  when action is required...	to continue the cooking process.
Touch the chamber...	to show the recipe details.
Touch "X"...	to cancel the cooking process.

8. At the end of the cooking process, the oven sounds an alert and the cavity light flashes.

9. **Open** the door and remove the hot food.



**NOTE:** Be sure to remove the cooked food after the cooking process is complete. If left inside the oven, the food will continue to cook.

## Result

The food is now cooked.

# How to Use the Multiple Timers

## Before you begin

### Make sure:

- The oven is preheated.
- Your food is prepared and ready to cook.

## Background

There may be times when you will want to cook multiple pans of food at the same time, but at different intervals. The dual timer function allows you to do so.

## Procedure

To cook using multiple timers, do the following.

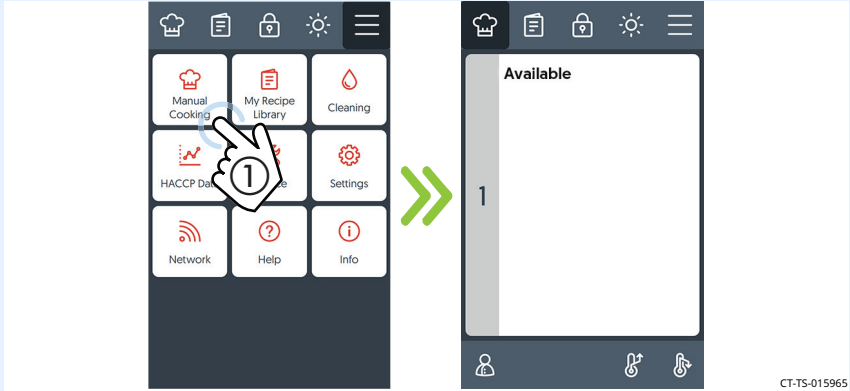
Step	Action
1.	<p><b>Touch</b> the manual cook icon ①. The manual cook screen displays.</p> 

*Continued on next page*



Continued from previous page

2. **Touch** the cavity ②.

**Touch** preheat, a cooking mode or an action step icon ③ to choose the step type.

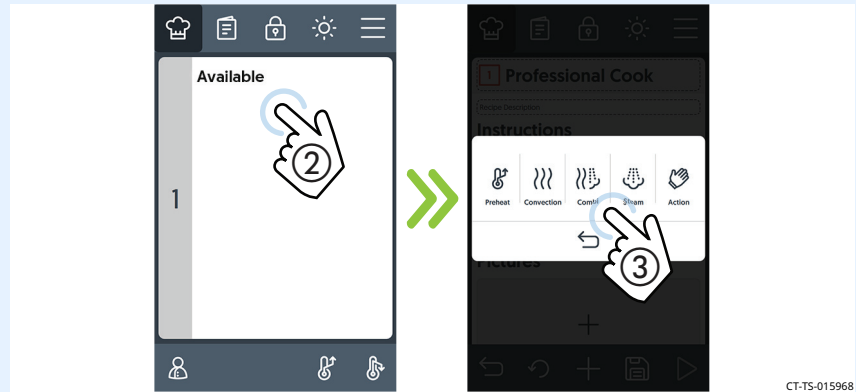

**NOTE:** Touching “Action” adds an action step to the recipe. An action adds manual tasks to be completed during the recipe such as loading the food or adding an ingredient.

3. The manual cook screen displays. The upcoming steps set the parameters for this screen.

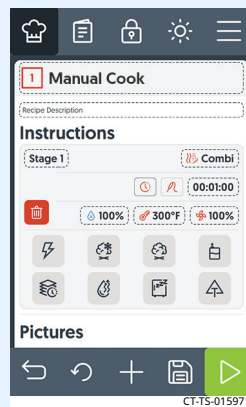

Continued on next page

Continued from previous page

4. **Touch** the multiple shelf icon ④.

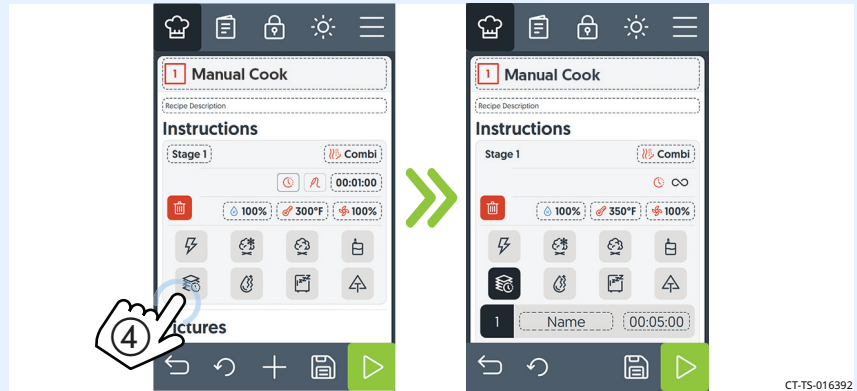

CT-TS-016392

5. **Touch** the cooking temperature icon ⑤. **Enter** the cooking temperature using the key pad.

**Touch** the humidity percentage icon ⑥. **Enter** the humidity percentage using the key pad.

**Touch** the fan speed icon ⑦. **Enter** the fan speed using the key pad. The fan speed can be set in increments of five percent.

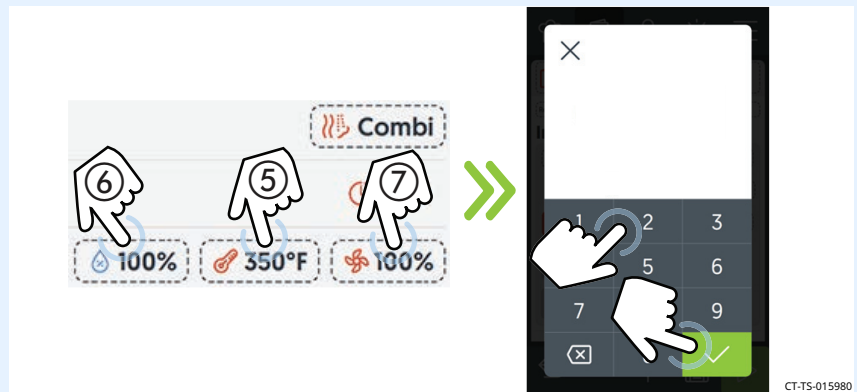

CT-TS-015980

Continued on next page

Continued from previous page

6. **Touch** the cooking time ⑧. **Enter** the cooking time using the key pad. **Touch** the check mark.



7. **Enter** the cooking time ⑨ for the second pan of food.

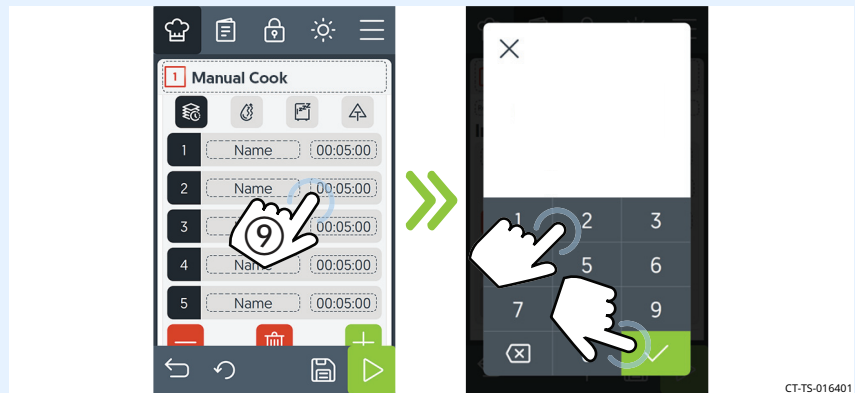

8. **Touch** the start icon ⑩.

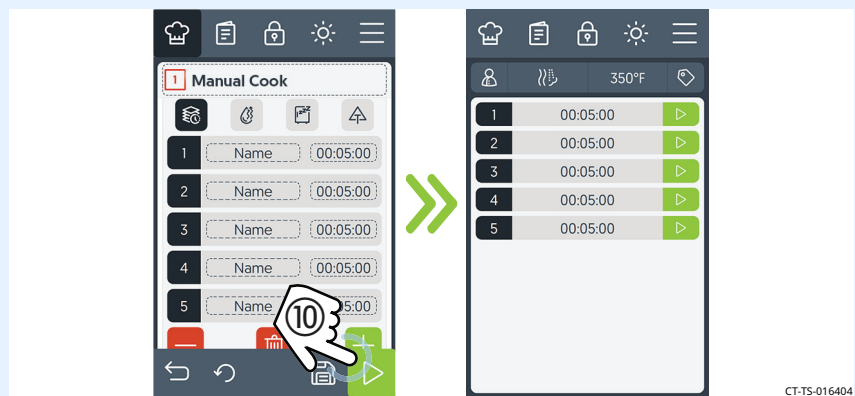

Continued on next page

Continued from previous page

9. **Load** pan 1 into the oven.

**Touch** the start icon ⑪.

The cooking stage timer starts to count down for pan 1.

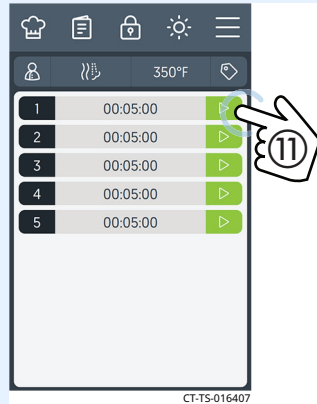

10. **Load** pan 2 into the oven.

**Touch** the start icon ⑫.

The cooking stage timer starts to count down for pan 2.

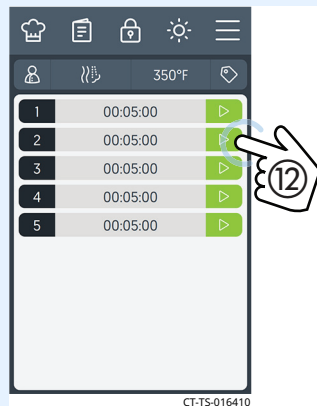

11. At the end of the cooking process, the oven sounds an alert and the cavity light flashes.

12. **Open** the door and remove the hot food.



**NOTE:** Be sure to remove the cooked food after the cooking process is complete. If left inside the oven, the food will continue to cook.

**Result**

The food is now cooked.

# How to Prepare the Smoker Box for Smoking

## Before you begin

- Use only wood chips supplied by Alto-Shaam.
- Clean the smoker box of used wood chips. Dispose of the burnt wood chips as directed by local codes.

## Procedure

To prepare the smoker box for smoking, do the following.



**WARNING:** Fire hazard.

The use of improper materials for the smoke function can result in a fire which may lead to personal injury or property damage.

Only use wood chips supplied by Alto-Shaam.

Step	Action
1.	<b>Soak</b> the wood chips in the clean water as instructed by National Fire Protection Agency Standard NFPA-96 or local codes. As of 2021, the NFPA-96 standard calls for a soaking period of 24 hours.
	 <p><b>WARNING:</b> Fire hazard. Soaking the wood chips in anything besides clean water may lead to personal injury or property damage. Only soak the wood chips in clean water.</p>
2.	<b>Shake off</b> excess water and place the moistened chips in the smoker box. <b>Close</b> the smoker box lid.
3.	<b>Install</b> the smoker box over the smoker element so that it rests in the cradle.
	



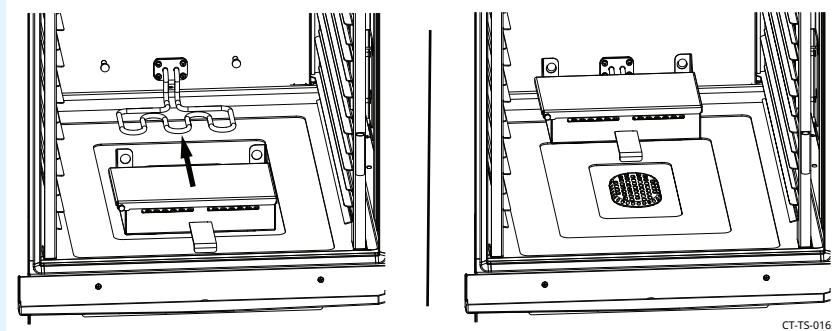

CT-TS-016362

## Result

The smoker box is now prepared for smoking.

# How to Hot Smoke in Manual Mode

**Background**

The smoking function can be used in convection mode or combination mode.

**Before you begin**

**Make sure:**



- The oven is preheated.
- Your food is prepared and ready to smoke.
- The wood chips have been soaked and the smoker box has been prepared for smoking. See topic *How to Prepare the Smoker Box for Smoking*.



**WARNING: Fire hazard.**  
The use of improper materials for the smoke function can result in a fire which may lead to personal injury or property damage.  
Only use wood chips supplied by Alto-Shaam.

**Procedure**

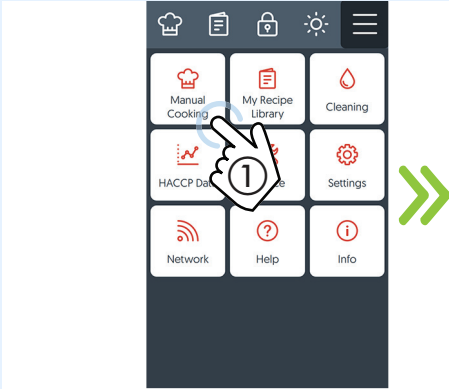
To hot smoke in manual mode, do the following.

Step	Action
1.	<p><b>Touch</b> the manual cook icon ①. The manual cook screen displays.</p> <div style="display: flex; align-items: center; justify-content: center;">   </div>

CT-TS-015965

*Continued on next page*

Continued from previous page

2. **Touch** the cavity ②.

**Touch** preheat, a cooking mode or an action step icon ③ to choose the step type.

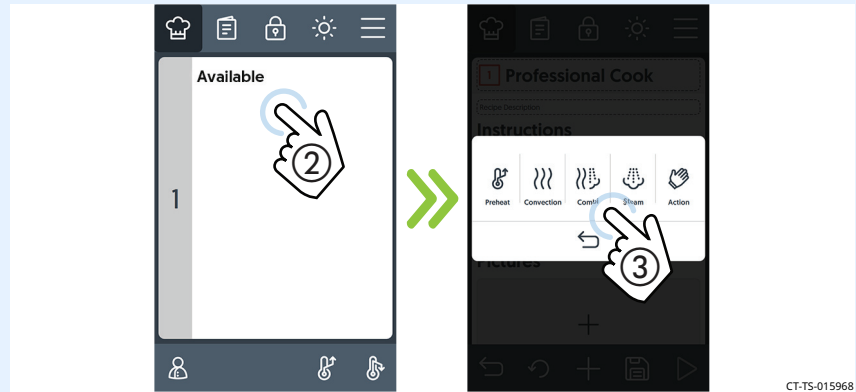

**NOTE:** Touching “Action” adds an action step to the recipe. An action adds manual tasks to be completed during the recipe such as loading the food or adding an ingredient.

3. The manual cook screen displays. The upcoming steps set the parameters for this screen.

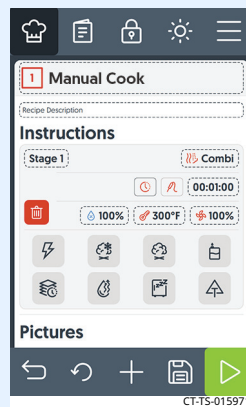

Continued on next page

Continued from previous page

**Cooking by time**

4. If cooking by time, **touch** the cook by time icon ④. Then, **touch** the cooking time ⑤. **Enter** the cooking time using the key pad. **Touch** the check mark.

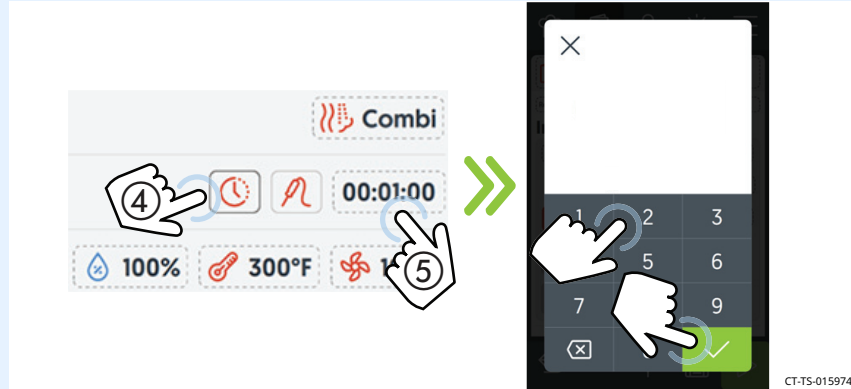

CT-TS-015974

**Cooking by probe**

5. If cooking by probe, **touch** the cook by probe icon ⑥. Then, **touch** the probe temperature ⑦. **Enter** the probe temperature set-point using the key pad. **Touch** the check mark.

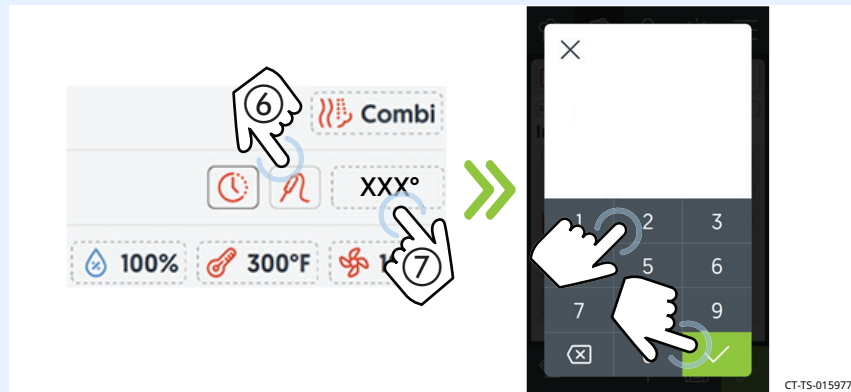

CT-TS-015977

Continued on next page



Continued from previous page

- 6. **Touch** the cooking temperature icon ⑧. **Enter** the cooking temperature using the key pad.

**Touch** the humidity percentage icon ⑨. **Enter** the humidity percentage using the key pad.

**Touch** the fan speed icon ⑩. **Enter** the fan speed using the key pad. The fan speed can be set in increments of five percent.

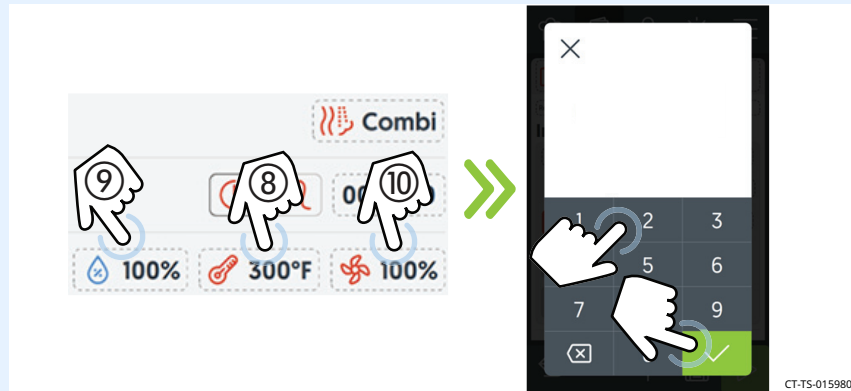

CT-TS-015980

- 7. **Touch** the hot smoke icon ⑪.

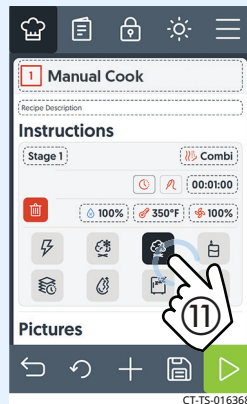

CT-TS-016368

- 8. **Touch** the plus (+) icon to add an additional step or action, if needed.

- 9. **Load** the food into the oven.

Continued on next page

Continued from previous page

10. **Touch** the start icon 12. The cooking process timer starts to count down.

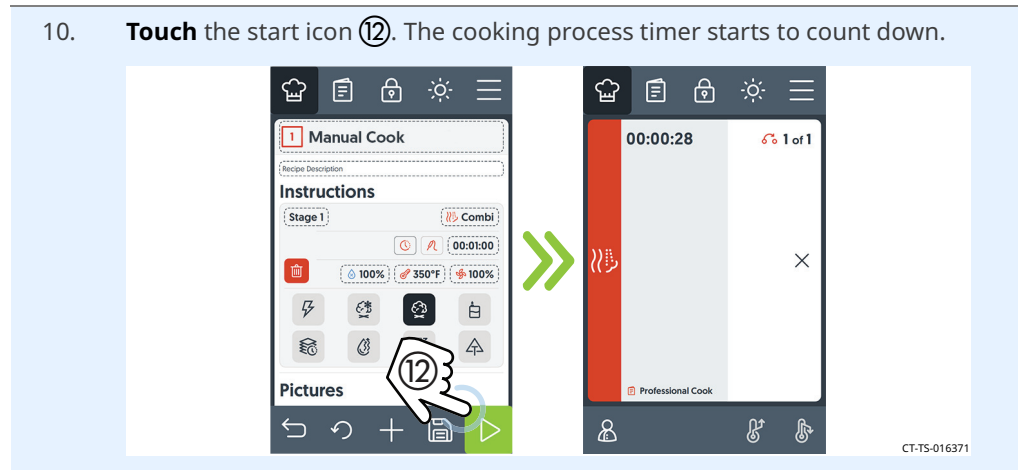

**During the cooking process**

Action	Result
Touch the hand icon  when action is required...	to continue the cooking process.
Touch the chamber...	to show the recipe details.
Touch "X"...	to cancel the cooking process.

11. At the end of the cooking process, the oven sounds an alert, and the cavity light and door handle light flash.

12. **Open** the door and remove the hot food.

**NOTE:** Be sure to remove the cooked food after the cooking process is complete. The oven will revert back to the preheat temperature. If left inside the oven, the food will continue to cook.

**Result**

The procedure is now complete.

# How to Cook using the Delta-T Core Temperature Cooking Mode

## Background

The Delta-T cooking mode cooks by internal product temperature with a probe. The Delta-T cooking mode increases the oven temperature in direct proportion to the internal temperature of the product. For example, the oven temperature will always be 100°F higher than the product itself. This slow cooking allows more time for enzymes to tenderize the meat. The Delta-T mode can be used with both convection mode and combination mode. Browning occurs toward the end of the cooking cycle.

## Before you begin

**Make sure** your food is prepared.

## Procedure

To cook using the Delta-T mode, do the following.

Step	Action
1.	<b>Touch</b> the manual cook icon ①. The manual cook screen displays.

*Continued on next page*

Continued from previous page

2. **Touch** the cavity ②.

**Touch** preheat, a cooking mode or an action step icon ③ to choose the step type.

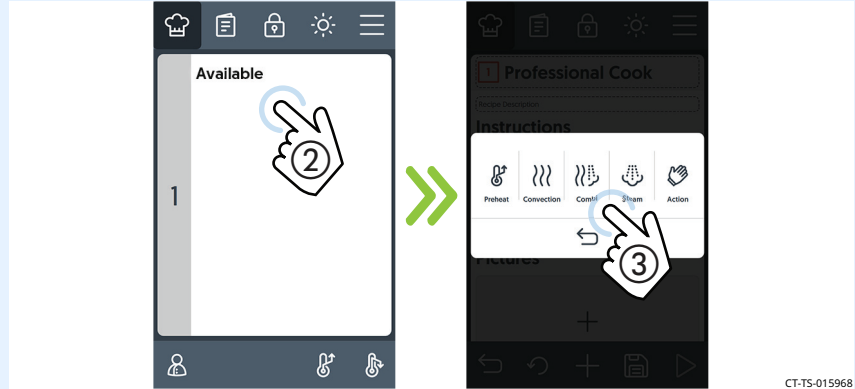

**NOTE:** Touching “Action” adds an action step to the recipe. An action adds manual tasks to be completed during the recipe such as loading the food or adding an ingredient.

3. The manual cook screen displays. The upcoming steps set the parameters for this screen.

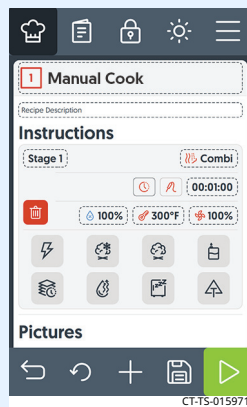

Continued on next page

Continued from previous page

4. **Touch** the Delta-T cooking mode icon ④.

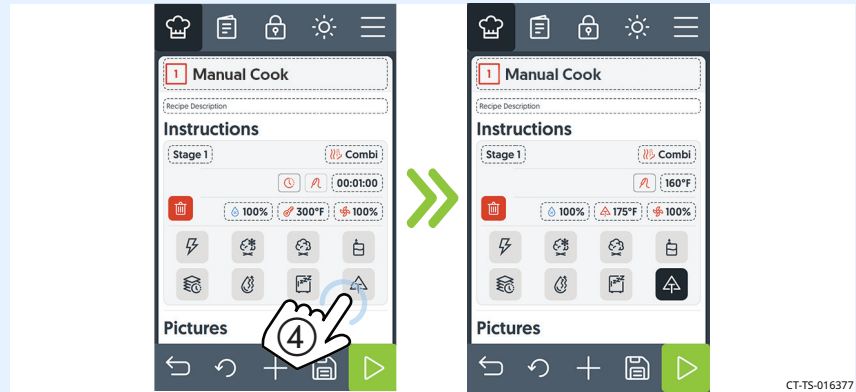

5. **Touch** the probe temperature ⑤. **Enter** the probe temperature set-point using the key pad. **Touch** the check mark.

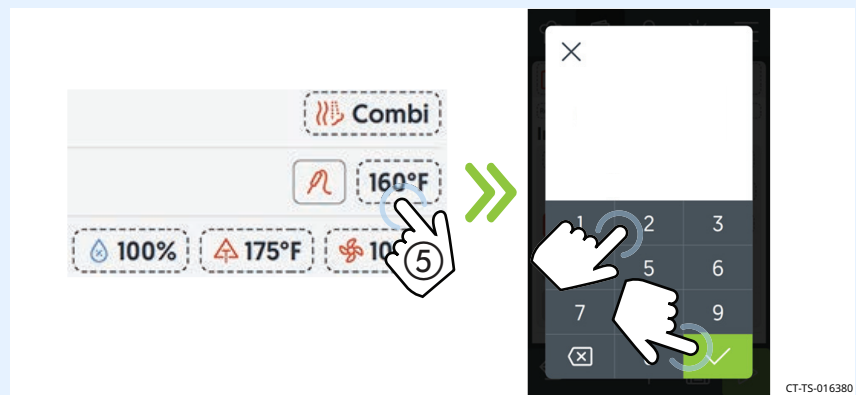

Continued on next page

Continued from previous page

6. **Touch** the Delta-T cooking temperature icon ⑥. **Enter** the cooking temperature using the key pad.
- Touch** the humidity percentage icon ⑦. **Enter** the humidity percentage using the key pad.
- Touch** the fan speed icon ⑧. **Enter** the fan speed using the key pad. The fan speed can be set in increments of five percent.

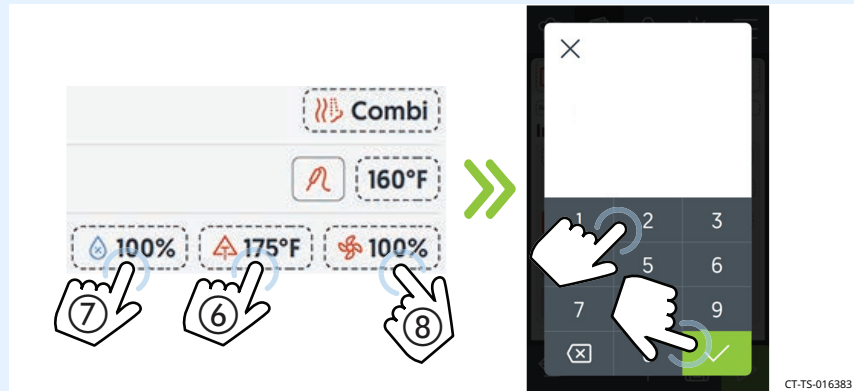

CT-TS-016383

7. **Touch** the plus (+) icon to add an additional step or action, if needed.
8. **Load** the food into the oven.
9. **Touch** the start icon ⑨. The cooking process timer starts to count down.



CT-TS-016386

Continued on next page

Continued from previous page

## During the cooking process

Action	Result
Touch the hand icon  when action is required...	to continue the cooking process.
Touch the chamber...	to show the recipe details.
Touch "X"...	to cancel the cooking process.

10. At the end of the cooking process, the oven sounds an alert, and the cavity light and door handle light flash.

11. **Open** the door and remove the hot food.

## Result

The procedure is now complete.

# How to Lock and Unlock the Screen

## Before you begin

The oven is turned on.

## Background

The screen can be locked to prevent changes being made during the cooking process.

## Procedure

To lock and unlock the screen, do the following.

Step	Action
1.	<p><b>Touch</b> the lock icon ①. The screen is now locked.</p> <p style="text-align: right;">CT-TS-015760</p>
2.	<p>To unlock the screen, <b>touch and hold</b> the lock icon ① and drag it to the right or left of the screen.</p> <p style="text-align: right;">CT-TS-015760</p>

## Result



The screen is now locked or unlocked.



# How to Cool Down the Oven

## Procedure

To cool down the oven, do the following.

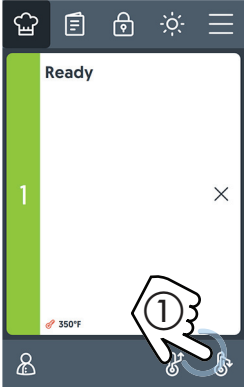
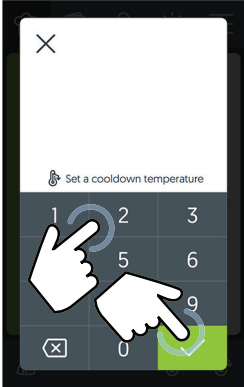
Step	Action
1.	<p>From the manual cooking screen, <b>touch</b> the cool down icon ①.</p> <p><b>Enter</b> the cool down temperature using the number pad. <b>Touch</b> the check mark. <b>Open</b> the door slowly to vent any steam for 3–5 seconds. Then, leave the door open 4 to 6 inches.</p> <div style="border: 1px solid orange; padding: 5px; margin: 10px 0;"> <p> <b>WARNING:</b> Burn hazard. Open the door carefully. Escaping hot vapors or steam can cause injury.</p> </div> <div style="border: 1px solid gray; padding: 5px; margin: 10px 0;"> <p> <b>NOTE:</b> The oven activates the convection fan for the cool down process. The oven deactivates the convection fan when the cool down process is complete.</p> </div> <div style="display: flex; justify-content: space-around; align-items: center; margin-top: 10px;">  <span style="font-size: 2em; color: green;">➤➤</span>  </div> <p style="text-align: right; font-size: 0.8em; margin-top: 5px;">CT-TS-015769</p>

## Cooling down progress bars

The progress bar indicates the oven's progress towards reaching its cool down temperature.

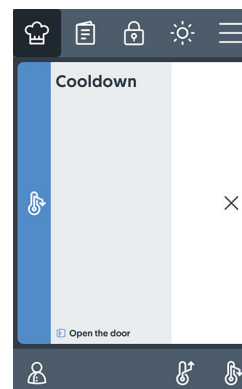

## Result

The oven is now cooled down.

# How to Create a Recipe

## Background

Creating a recipe consists of:

- Setting the cooking stage(s) parameters (temperature, time, humidity percentage, and fan speed);
- setting an action step if desired such as adding an ingredient;
- naming the recipe;
- adding a description to the recipe;
- adding a photo to the recipe;
- and adding the recipe to a category.

## Procedure

To create a recipe, do the following.

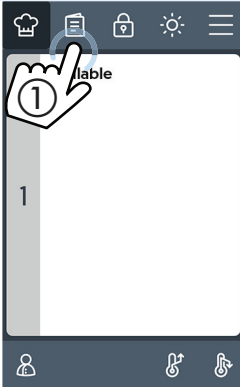
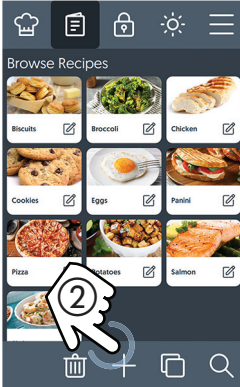
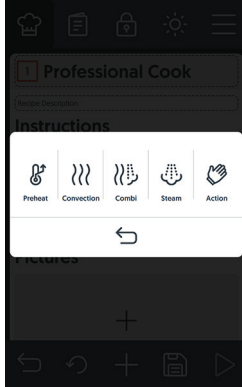
Step	Action
1.	<p><b>Touch</b> the recipe book icon ①. The browse recipes screen displays.</p>   <p style="text-align: right;">CT-TS-014444</p>
2.	<p><b>Touch</b> the plus icon ②. The step type screen displays.</p>   <p style="text-align: right;">CT-TS-014453</p>

*Continued on next page*

Continued from previous page

3. **Touch** the step type icon ③ to choose the step type.

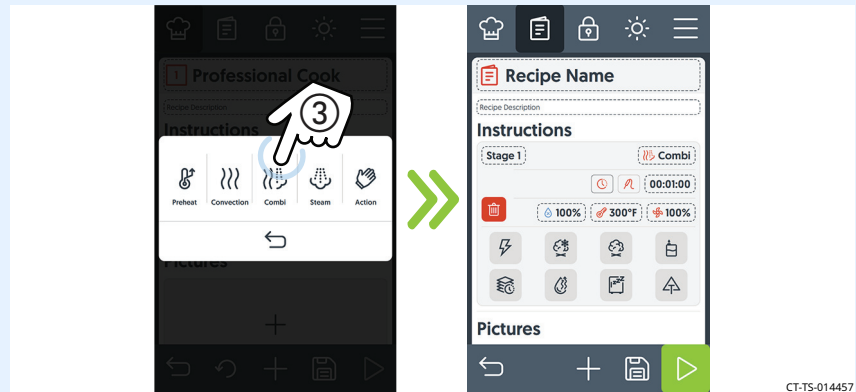

**NOTE:** Touching “Action” adds an action step to the recipe. An action adds manual tasks to be completed during the recipe such as loading the food or adding an ingredient.

4. **Touch** “Recipe Name” ④. The recipe name screen displays.

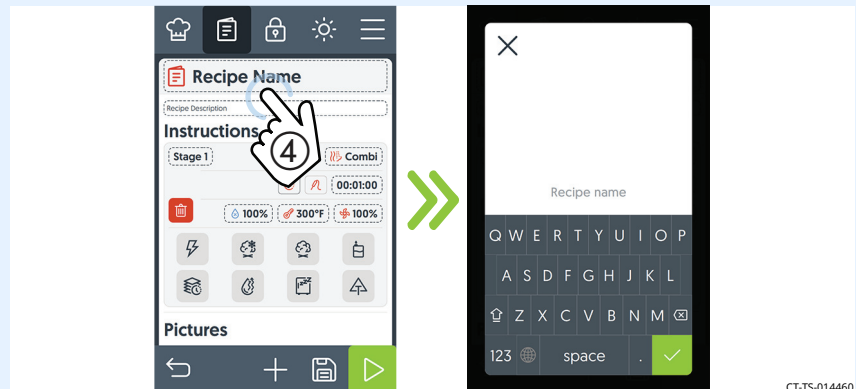

5. **Enter** the recipe name. **Touch** the check mark icon ⑤ to return to the create recipe screen.

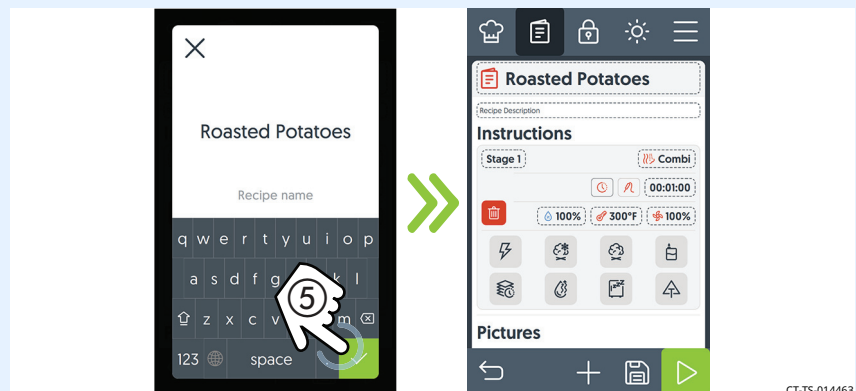

Continued on next page

Continued from previous page

6. **Touch** "Recipe Description" ⑥. The recipe description screen displays. **Enter** the recipe description. **Touch** the check mark icon to return to the create recipe screen.

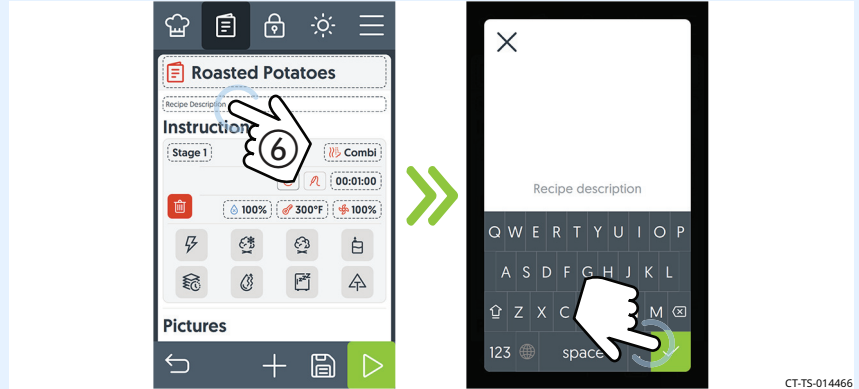

CT-TS-014466

7. **Touch** the cook by time icon or cook by probe icon ⑦. **Touch** the cooking time or probe set-point temperature ⑧. **Enter** the cooking time or probe temperature using the key pad. **Touch** the check mark.

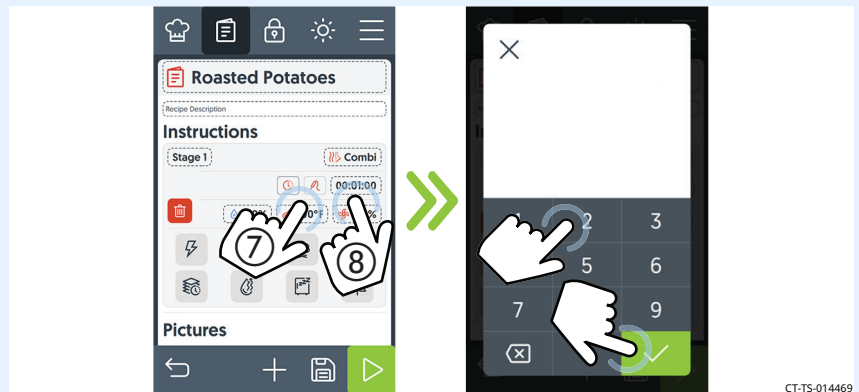

CT-TS-014469

Continued on next page

Continued from previous page

8. **Touch** the humidity icon ⑨. **Enter** the humidity percentage using the key pad. **Touch** the check mark.

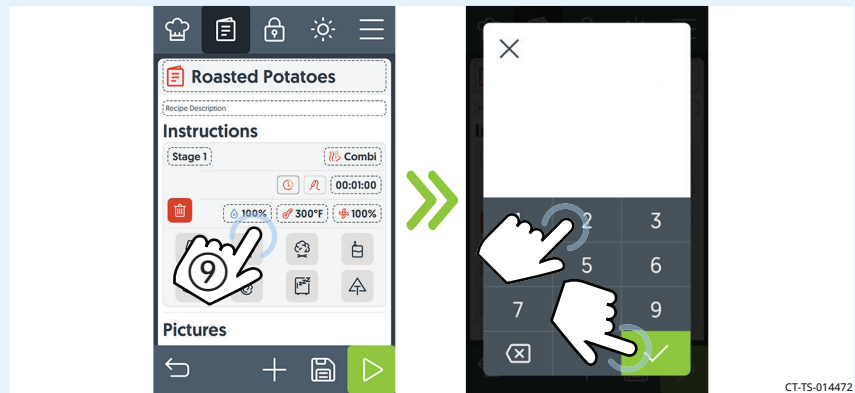

CT-TS-014472

9. **Touch** the chamber temperature set-point icon ⑩. **Enter** the chamber temperature set-point using the key pad. **Touch** the check mark.

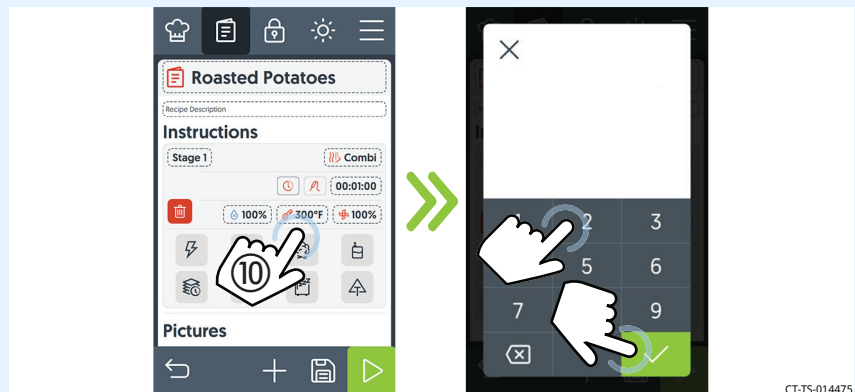

CT-TS-014475

10. **Touch** the fan speed icon ⑪ to set the fan speed. **Touch** the check mark.

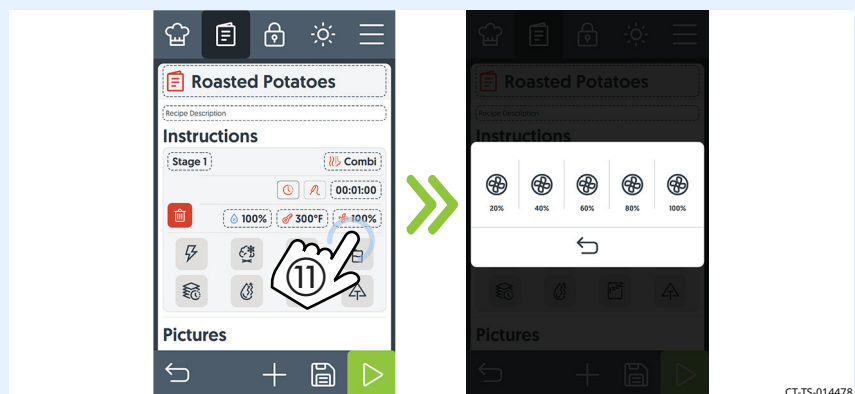

CT-TS-014478

Continued on next page

Continued from previous page

11. **Touch** the plus icon ⑫ to add an additional stage or action.  
**Touch** the delete icon ⑬ to delete a stage or action.

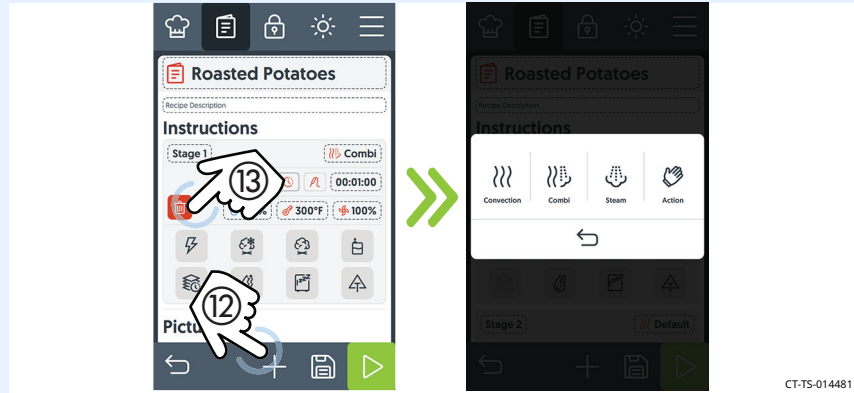

12. **Scroll** to "Pictures" to add a photo to the recipe.
13. **Scroll** to "Categories" to add the recipe to a category.
14. **Touch** the save icon ⑭ when finished to save the recipe.

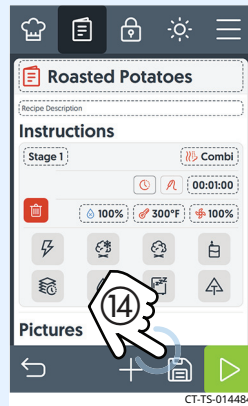

**Result**

A new recipe has been created.

# How to Modify, Duplicate, or Delete a Recipe

## Procedure

To modify, duplicate, or delete a recipe, do the following.

Step	Action
1.	<b>Touch</b> the recipe book icon ①. The “Browse Recipes” screen displays.
2.	To modify a recipe, <b>touch</b> the recipe edit icon ② of the desired recipe.

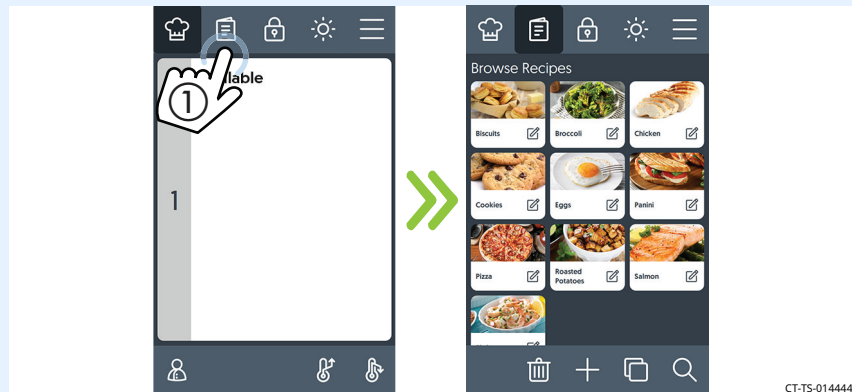

CT-TS-014444

## Modifying

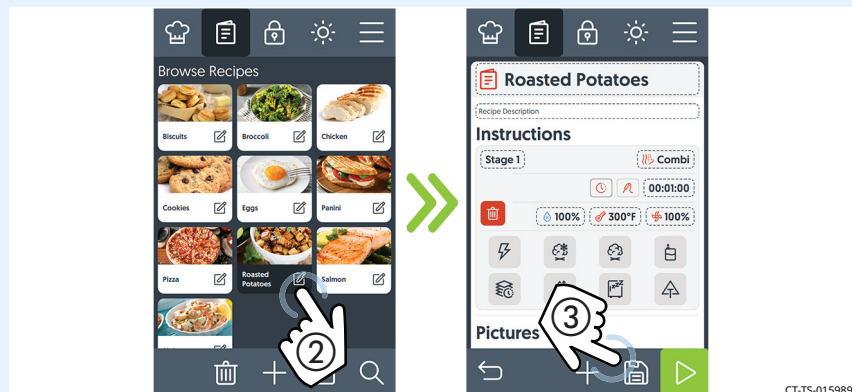

CT-TS-015989

The first stage of the recipe displays. Scroll to the stage you want to modify.

- **Touch** the cook by time or cook by probe icon then modify the value using the key pad.
- **Touch** the humidity icon to modify the humidity percentage.
- **Touch** the chamber set-point icon to modify the chamber temperature.
- **Touch** the fan speed icon to modify the fan speed.

**Touch** the save icon ③ when finished.

**Touch** the trash icon to delete the stage, if desired.

*Continued on next page*

Continued from previous page

### Duplicating

- To duplicate a recipe, **touch** the duplicate recipe icon ④ of the desired recipe.

**Touch** the recipe to copy it. The recipe copy will display at the bottom of the recipe list. Edit the copied recipe as desired.

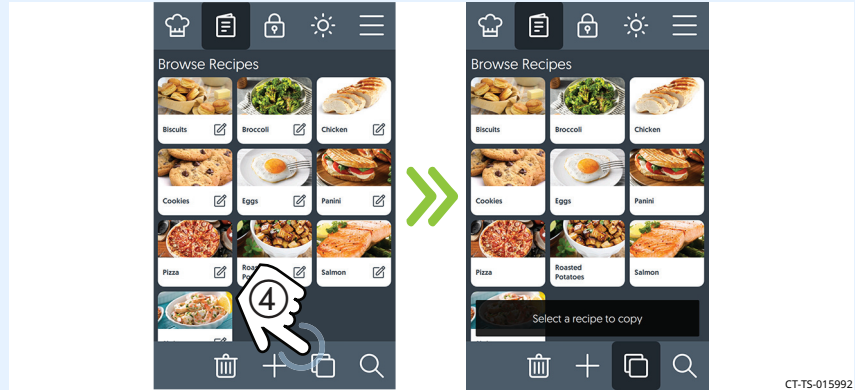

CT-TS-015992

### Deleting

- To delete a recipe, **touch** the delete icon ⑤.

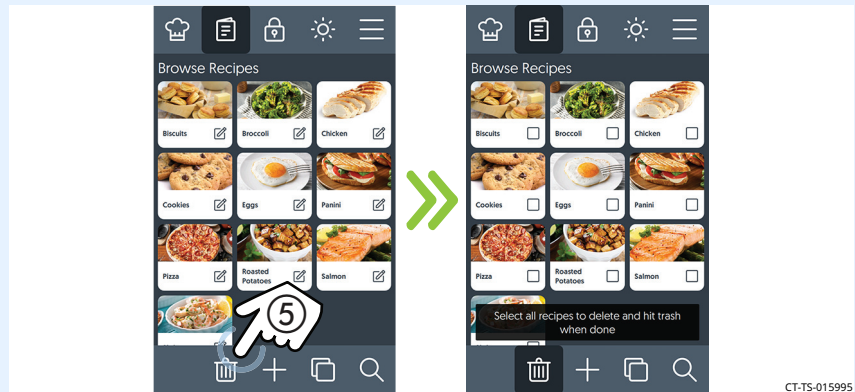

CT-TS-015995

**Select** the recipe(s) that you want to delete. **Touch** the delete icon again.

**Touch** "Continue" to confirm that you want to delete the recipe(s).

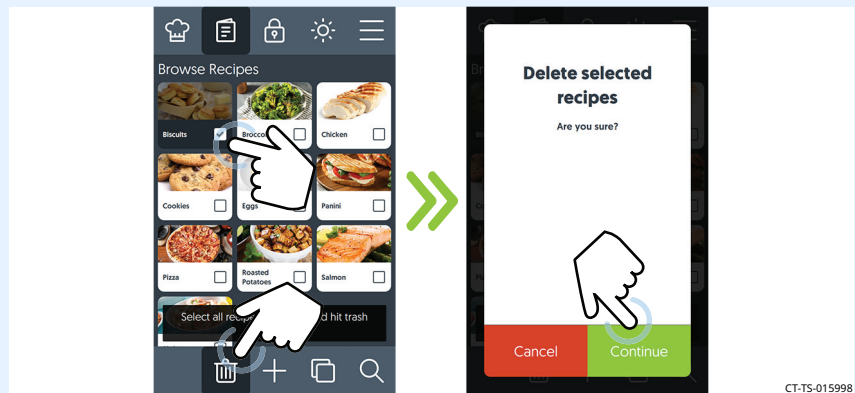

CT-TS-015998

### Result

The procedure is now complete.



# How to Create a Category

## Background

A category allows the user to label and group recipes together. When viewing a recipe, the user can add a recipe to a category by touching the check mark next to the desired category. The categories can be viewed at the bottom of an existing recipe screen.

Each category must contain at least one recipe. A recipe can be assigned to multiple categories

## Procedure

To create a category, do the following.

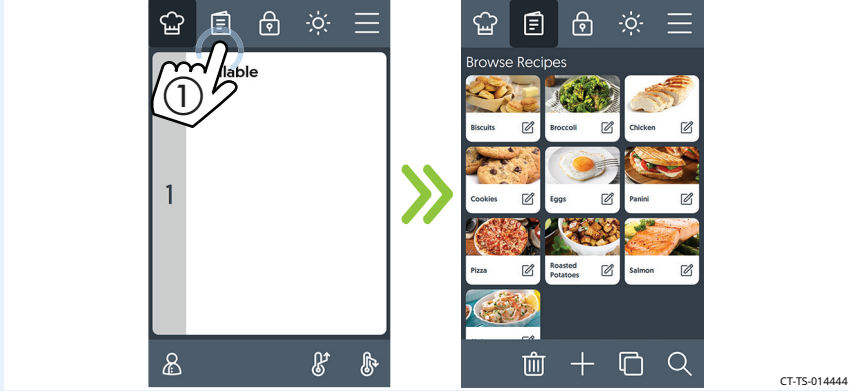
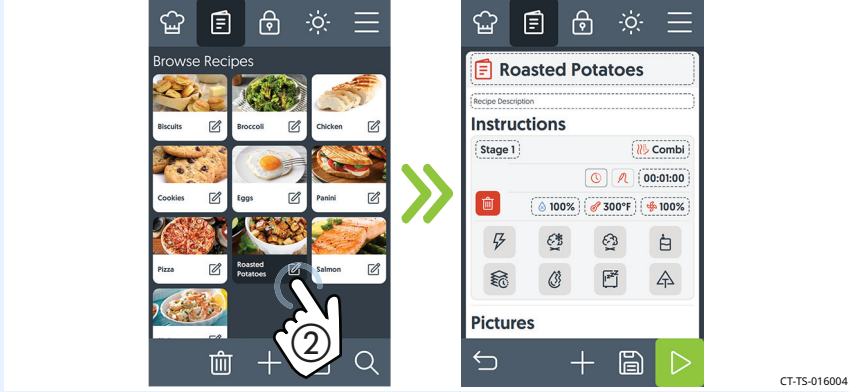
Step	Action
1.	<p><b>Touch</b> the recipe book icon ①. The “Browse Recipes” screen displays.</p>  <p>CT-TS-014444</p>
2.	<p><b>Touch</b> an existing recipe edit icon ②.</p>  <p>CT-TS-016004</p>

*Continued on next page*

Continued from previous page

3. **Scroll** to “Categories”. **Touch** the plus icon ③ to add a category.

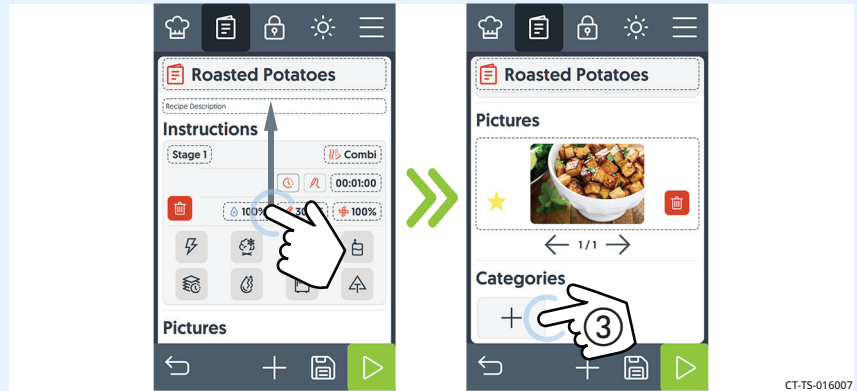

4. **Enter** the category name. **Touch** the check mark ④.

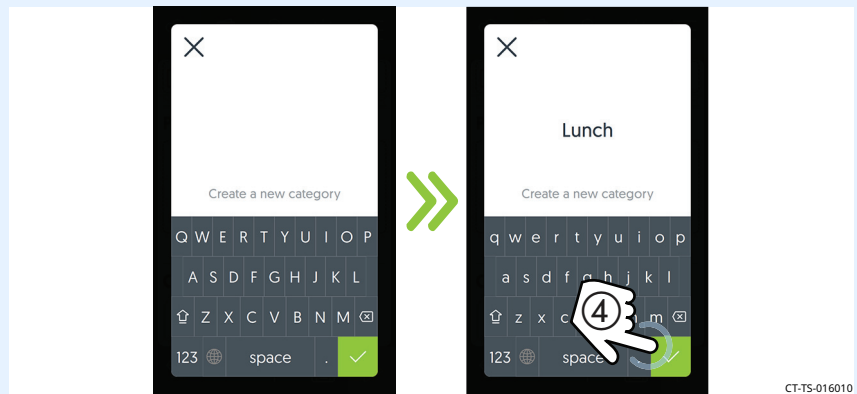

Continued on next page

Continued from previous page

5. **Touch** the check box ⑤ on a category to select the category. This saves the current recipe to the category.

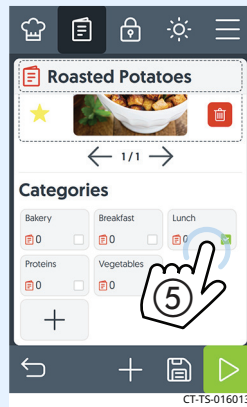

### Deleting a Category

A category is deleted automatically when all recipes have been deleted from the category.

### Result

The category has now been created.

# How to Backup or Restore Settings with a USB Drive

## Before you begin

### Make sure:

- The oven is on, but not in a cooking mode.
- You will need a USB drive.

## Procedure

To backup or restore settings with a USB drive, do the following.

Step	Action
1.	<p><b>Touch</b> the menu icon ①. The menu screen displays.</p>  <p style="text-align: right;">CT-TS-014429</p>
2.	<p><b>Touch</b> the "Settings" icon ②. The "General Settings" screen displays.</p>  <p style="text-align: right;">CT-TS-014432</p>

*Continued on next page*

Continued from previous page

3. **Plug** the USB drive ③ into the port.

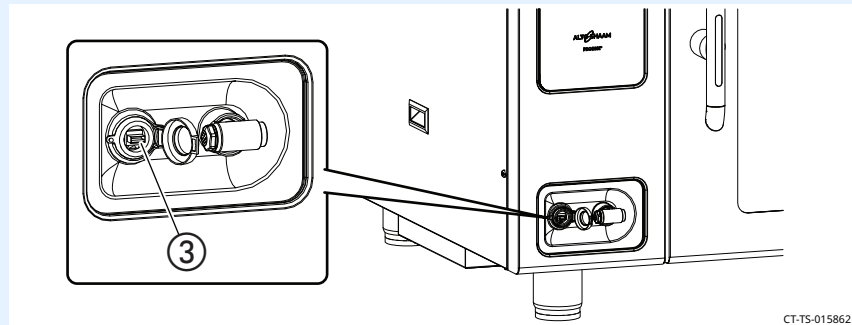

4. **Scroll** to “System Backup & Update.”  
**Touch** “Backup settings to USB” or “Restore settings from USB” ④.

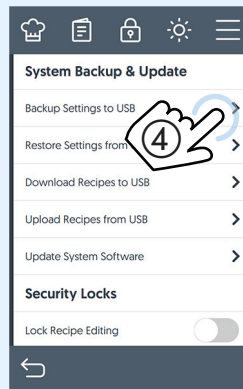

## Loading the recipes

The oven downloads or restores the settings. When the process is complete, **touch** the check mark to return to the general settings screen. **Remove** the USB drive.

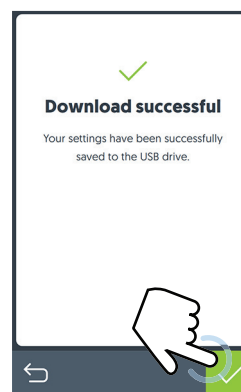

## Result

The settings have now been saved to the USB drive or restored from the USB drive.

# How to Load Recipes from a USB Drive

## Before you begin

### Make sure:

- The oven is on, but not in a cooking mode.
- You will need a USB drive loaded with recipes.

## Procedure

To load recipes from the USB drive to the oven, do the following.

Step	Action
1.	<p><b>Touch</b> the menu icon ①. The menu screen displays.</p>  <p style="text-align: right;">CT-TS-014429</p>
2.	<p><b>Touch</b> the "Settings" icon ②. The "General Settings" screen displays.</p>  <p style="text-align: right;">CT-TS-014432</p>

*Continued on next page*

Continued from previous page

3. **Plug** the USB drive ③ into the port.

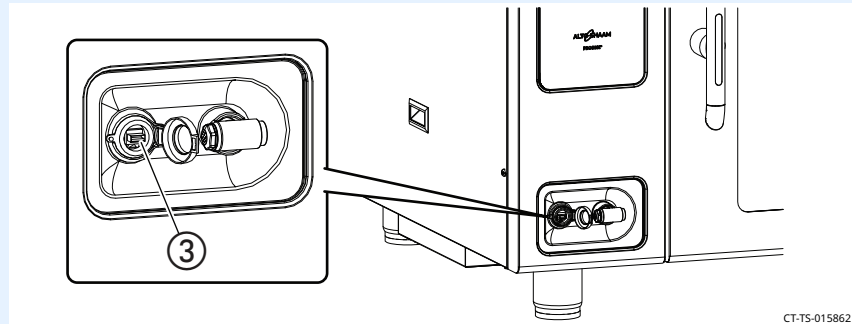

CT-TS-015862

4. **Scroll** to “System Backup & Update.”  
**Touch** the “Upload Recipes from USB” ④ setting.

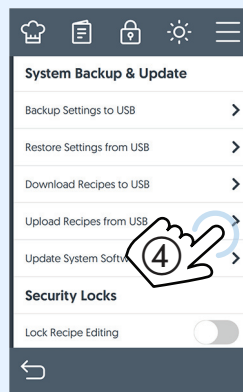

CT-TS-015874

### Loading the recipes

The oven loads the recipe file. When the process is complete, the “Recipes uploaded” screen displays. **Touch** the check mark to return to the general settings screen. **Remove** the USB drive.

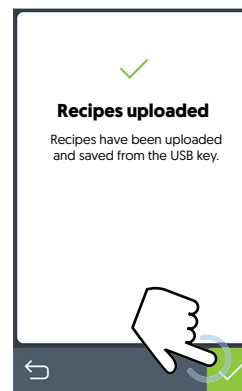

CT-TS-015877

### Result

The recipes are now loaded.

# How to Save Recipes to a USB Drive

## Before you begin

### Make sure:

- The oven is on, but not in a cooking mode.
- You will need a USB drive.

## Procedure

To download recipes from the oven to a USB drive, do the following.

Step	Action
1.	<p><b>Touch</b> the menu icon ①. The menu screen displays.</p>  <p>CT-TS-014429</p>
2.	<p><b>Touch</b> the "Settings" icon ②. The "General Settings" screen displays.</p>  <p>CT-TS-014432</p>

*Continued on next page*



Continued from previous page

3. **Plug** the USB drive ③ into the port.

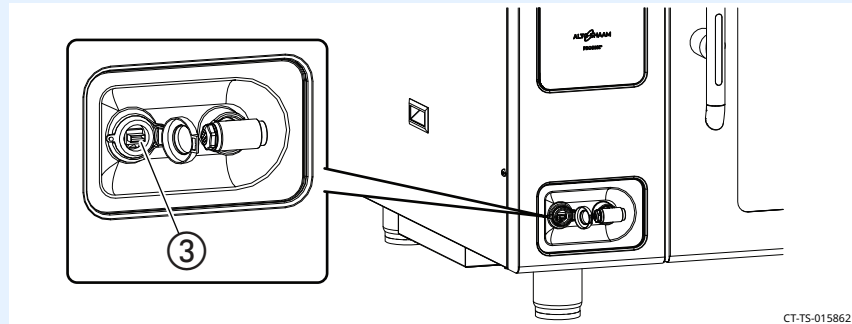

CT-TS-015862

4. **Scroll** to "System Backup & Update."  
**Touch** the "Download Recipes to USB" ④ setting.

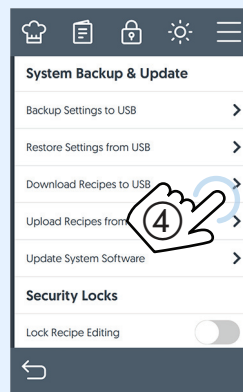

CT-TS-015883

## Loading the recipes

The oven downloads the recipes onto the USB drive. When the process is complete, the "Download successful" screen displays. **Touch** the check mark to return to the general settings screen. **Remove** the USB drive.

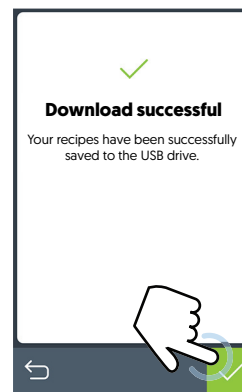

CT-TS-015886

## Result

The recipes are now saved to the USB drive.

# How to Update Software with a USB Drive

## Before you begin

### Make sure:

- The oven is on and cool to the touch (room temperature).
- You will need a USB drive with the updated software. To download the most up to date oven software and register for email notifications when new software versions are released, please visit <https://www.alto-shaam.com/en/customer-support/software-downloads>.
- Do not remove the USB drive during the update process.

## Procedure

To update the software, do the following.

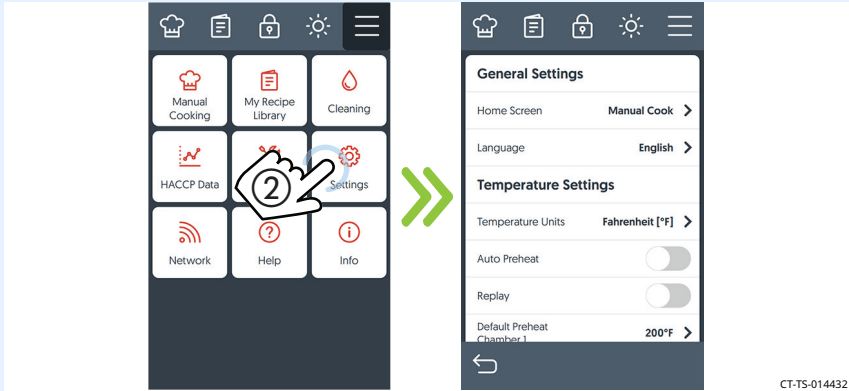
Step	Action
1.	<p><b>Touch</b> the menu icon ①. The menu screen displays.</p>  <p style="text-align: right;">CT-TS-014429</p>
2.	<p><b>Touch</b> the “Settings” icon ②. The “General Settings” screen displays.</p>  <p style="text-align: right;">CT-TS-014432</p>

*Continued on next page*

Continued from previous page

3. **Plug** the USB drive ③ into the port.

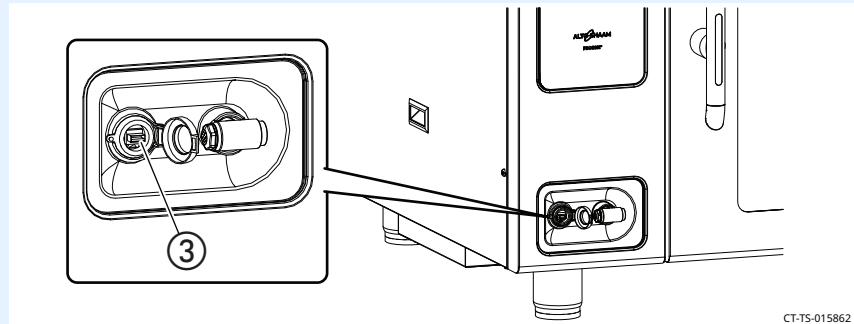

CT-TS-015862

4. **Scroll** to “System Backup & Update.”  
**Touch** the “Update System Software” ④ setting.

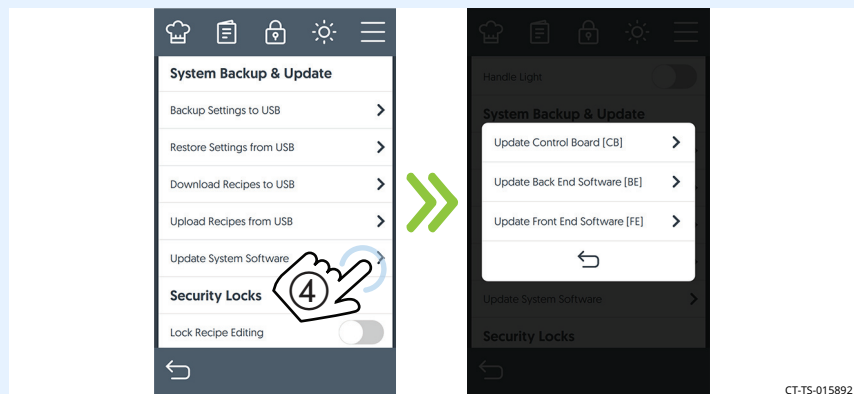

CT-TS-015892

**NOTICE** Do not remove the USB drive during the update process.

**Touch** “Update Back End Software” to update the supporting software between the control board (CB) and interface board (IB). The oven loads the selected software.

**Touch** “Update Front End Software” to update the user interface software. The oven loads the selected software.

**Touch** “Update Control Board (CB)” to update the control board. The oven loads the selected software. The oven verifies the file and then updates the CB.

Continued on next page

Continued from previous page

5. **Touch** the check mark when the update is complete to restart the oven.

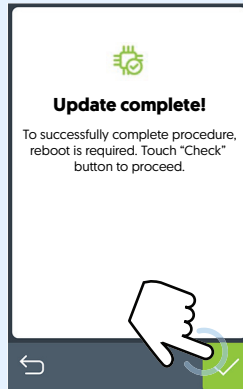

CT-TS-015895

6. **Remove** the USB drive.

**Result**

The software has now been updated.

# How to Change the Home Screen

## Procedure

To change the home screen, do the following.

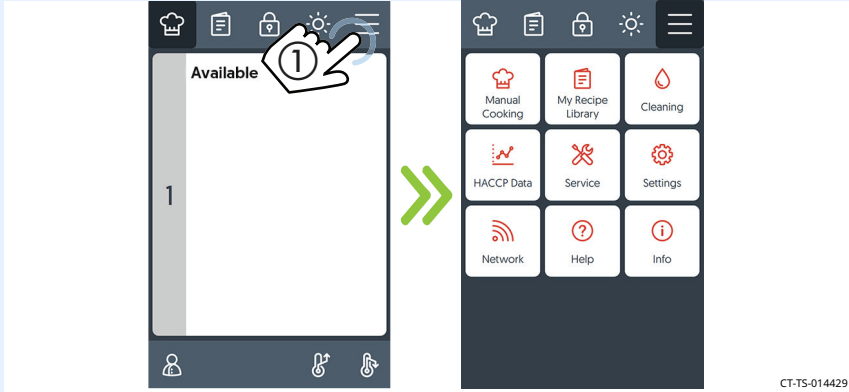
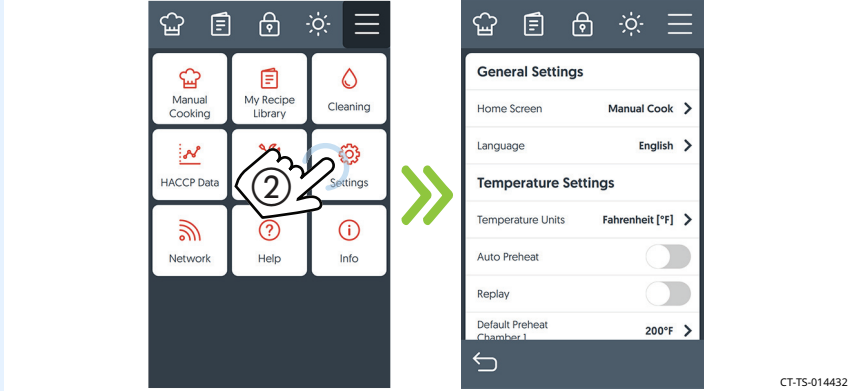
Step	Action
1.	<p><b>Touch</b> the menu icon ①. The menu screen displays.</p>  <p>CT-TS-014429</p>
2.	<p><b>Touch</b> the "Settings" icon ②. The "General Settings" screen displays.</p>  <p>CT-TS-014432</p>

*Continued on next page*

Continued from previous page

3. **Touch** the “Home Screen” setting ③. The select home screen menu displays.

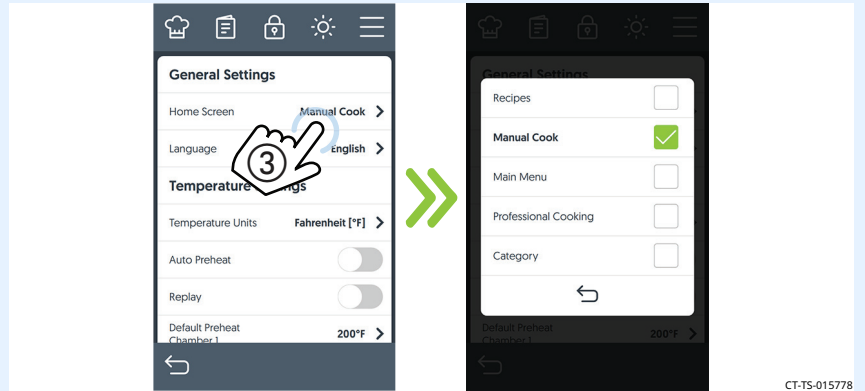

4. **Select** your desired home screen from the list.  
**Touch** the check mark ④ to save the home screen setting.

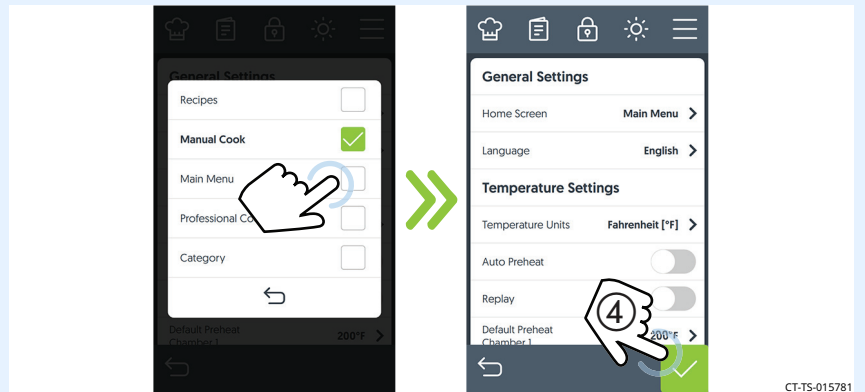

5. **Restart** the oven to reboot the home screen.

**Result**

The home screen has now been changed.

# How to Change the Temperature Scale

## Procedure

To change the temperature scale from °F to °C and vice versa, do the following.

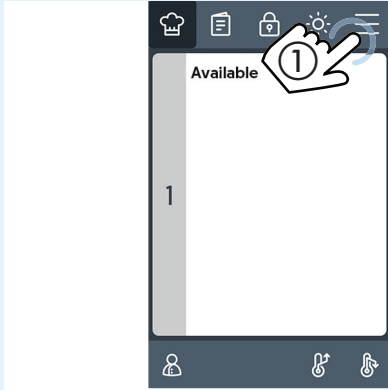
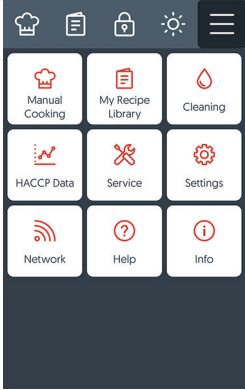
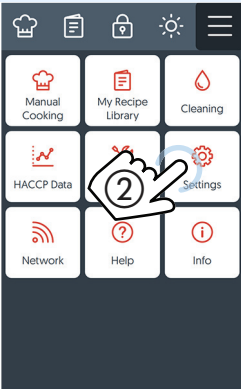
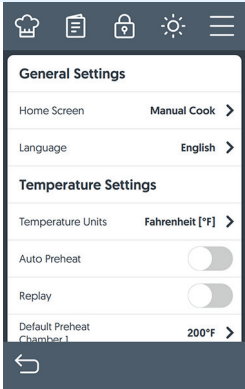
Step	Action
1.	<p><b>Touch</b> the menu icon ①. The menu screen displays.</p>  
2.	<p><b>Touch</b> the "Settings" icon ②. The "General Settings" screen displays.</p>  

*Continued on next page*

Continued from previous page

3. **Touch** the “Temperature Units” setting ③. The select temperature units screen displays.

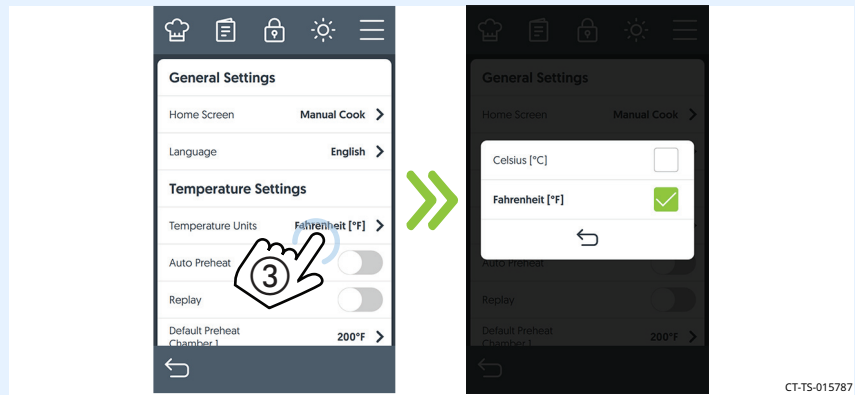

4. **Select** your desired temperature scale.  
**Touch** the check mark ④ to save the temperature scale setting.

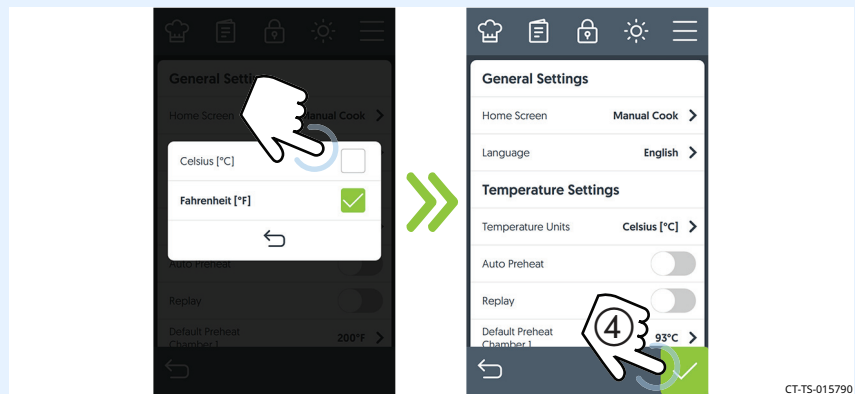

**Result**

The temperature scale has now been changed.



# How to Enable/Disable the Handle Light

## Procedure

To enable the handle light, do the following.

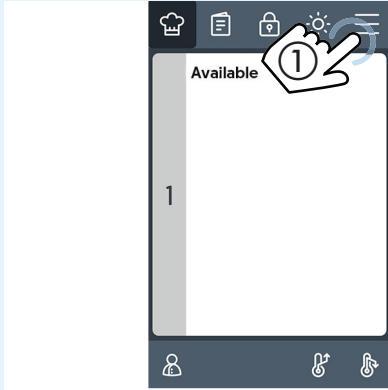
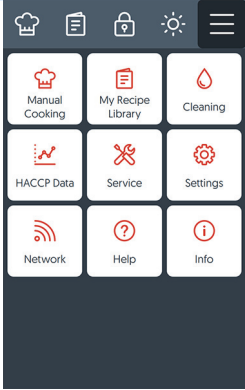
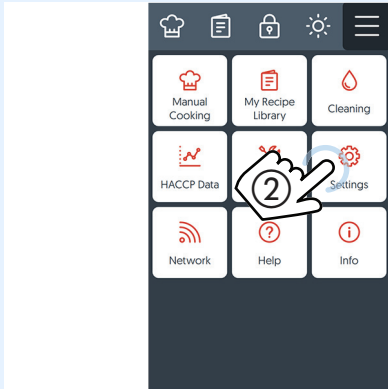
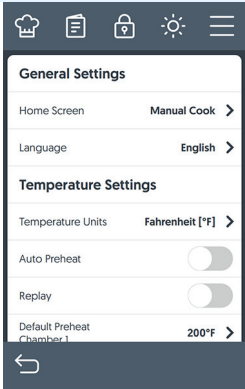
Step	Action
1.	<p><b>Touch</b> the menu icon ①. The menu screen displays.</p>  
2.	<p><b>Touch</b> the "Settings" icon ②. The "General Settings" screen displays.</p>  

*Continued on next page*

Continued from previous page

3. **Scroll** to the “Handle Light” setting.  
**Touch** the Handle Light button ③. **Touch** the check mark ④. The handle light is now enabled.

**Repeat** the procedure to disable the handle light.

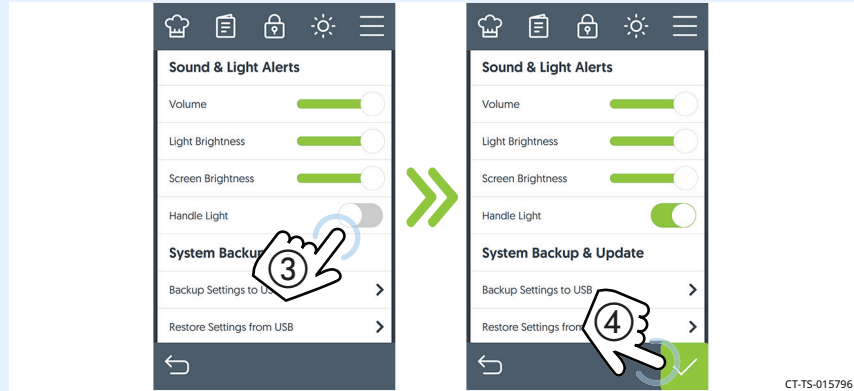

CT-TS-015796

**Result**

The handle light is now enabled/disabled.

# How to Enable/Disable Automatic Preheat

## Background

Enabling the automatic preheat function preheats the oven upon start up to the set preheat temperature. Make sure to set your preheat temperatures. See topic *How to Preheat the Oven*.

## Procedure

To enable/disable automatic preheat, do the following.

Step	Action
1.	<p><b>Touch</b> the menu icon ①. The menu screen displays.</p>  <p>CT-TS-014429</p>
2.	<p><b>Touch</b> the “Settings” icon ②. The “General Settings” screen displays.</p>  <p>CT-TS-014432</p>

*Continued on next page*

Continued from previous page

3. **Touch** the “Auto Preheat” button ③. **Touch** the check mark ④. The automatic preheat function is now enabled.

**Repeat** the process to disable the automatic preheat function.

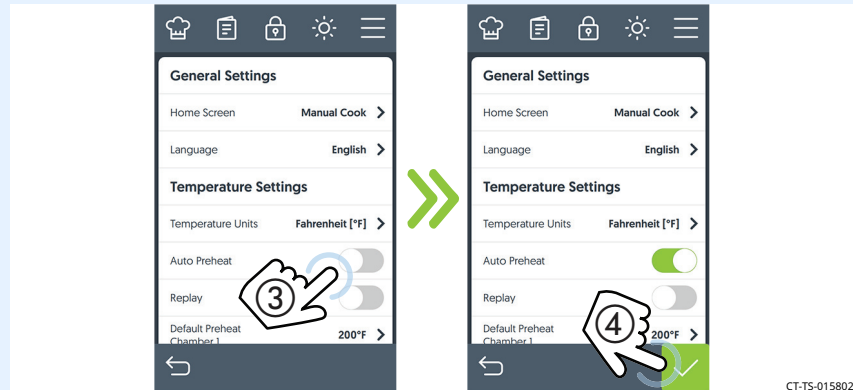

## Result

The automatic preheat function is now enabled/disabled.

# How to Enable and Use the Replay Function

## Background

When a cooking process is complete, the replay function repeats the same cooking process when you touch the replay icon. The replay function can be used for a programmed recipe or manual cook.

## Procedure

To enable the replay function, do the following.

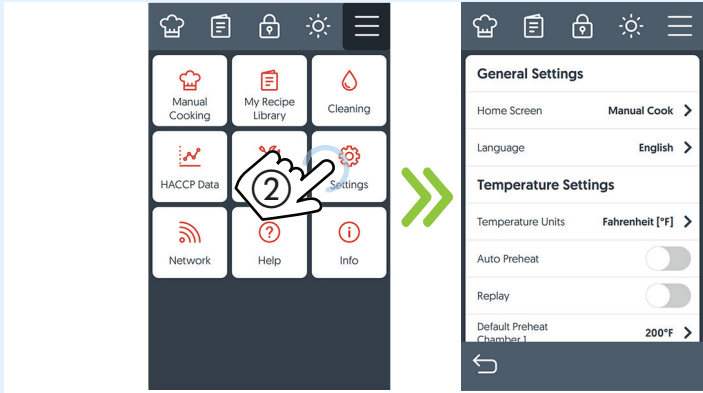
Step	Action
1.	<p><b>Touch</b> the menu icon ①. The menu screen displays.</p> 
2.	<p><b>Touch</b> the "Settings" icon ②. The "General Settings" screen displays.</p> 

*Continued on next page*

Continued from previous page

3. **Scroll** to the “Temperature Settings.”  
**Touch** the Replay button ③. **Touch** the check mark ④. The replay function is now enabled.

**Repeat** the process to disable the replay function.

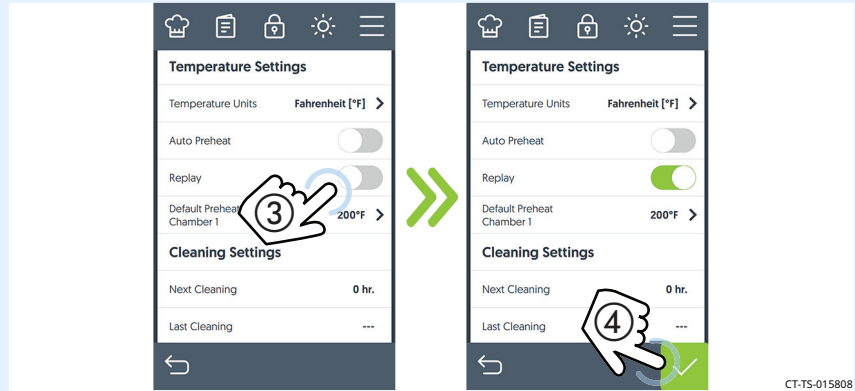

**Using the replay function (if enabled)**

4. When the cooking process is complete, the screen will say “Done”. **Touch** the hand icon ⑤. **Remove** the food from the oven.

**Load** the next tray into the oven.

If the replay function is enabled, **touch** the replay icon ⑥ to repeat the previous cooking process.

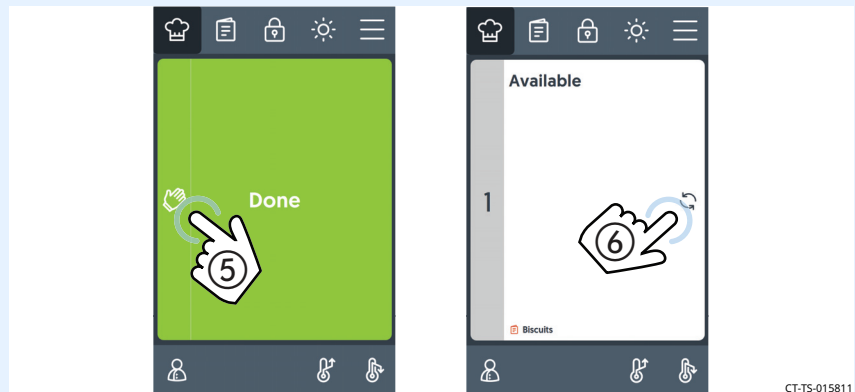

**Result**

The procedure is now complete.

# How to Lock Recipe Editing, Manual Cooking, or the Settings Screen

## Procedure

To lock recipe editing, manual cooking, or the settings screen, do the following.

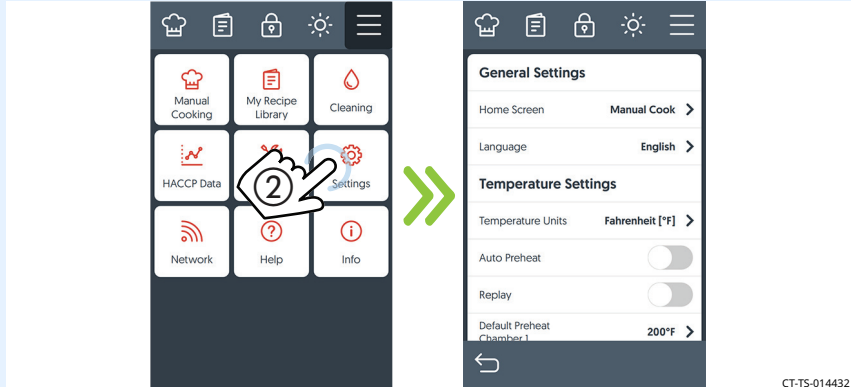
Step	Action
1.	<p><b>Touch</b> the menu icon ①. The menu screen displays.</p>  <p>CT-TS-014429</p>
2.	<p><b>Touch</b> the "Settings" icon ②. The "General Settings" screen displays.</p>  <p>CT-TS-014432</p>

*Continued on next page*

Continued from previous page

3. **Scroll** to the “Security Locks.”

**Touch** the Lock Recipe Editing button ③. The “Enter passcode” screen displays.

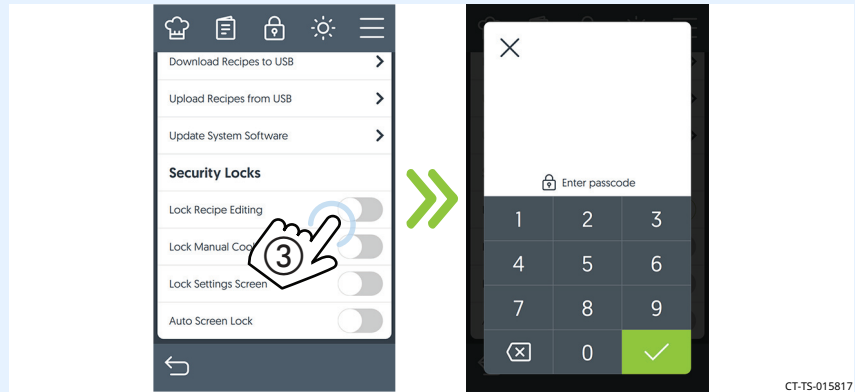

4. **Create** a passcode ④ using the keypad. **Touch** the check mark ⑤.

**Touch** the check mark ⑥ to lock recipe editing.

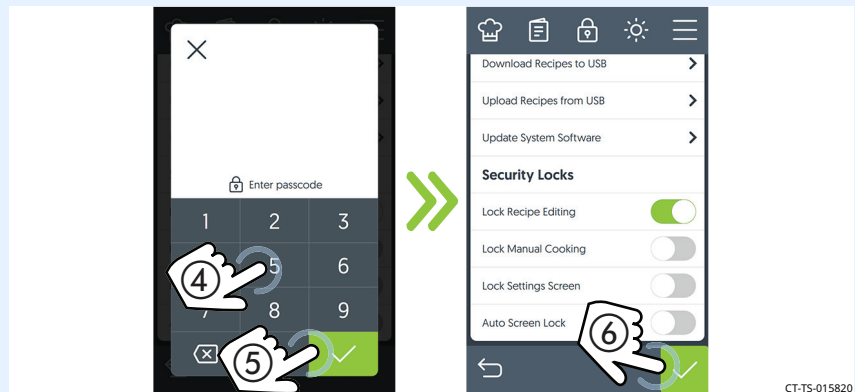

5. **Repeat** the process to lock manual cooking or lock the settings screen.

**Result**

The lock recipe editing, manual cooking, or the settings screen are now locked.



# How to View Oven Information

## Background

This procedure is to be done through the touchscreen on the oven, not through the ChefLinc™ oven management system.

The oven information screen shows the oven model, serial number, software version, and system information.

## Procedure

To view oven information, do the following.

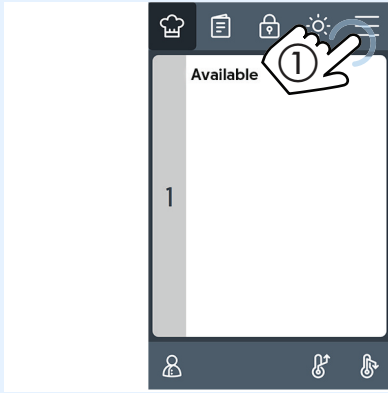
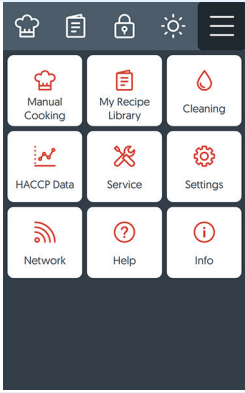
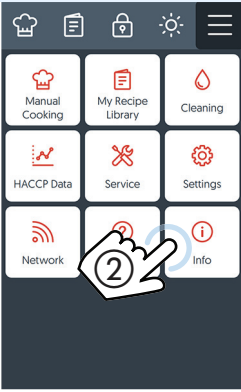
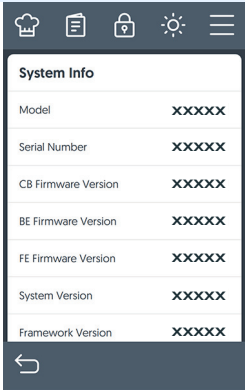
Step	Action
1.	<p><b>Touch</b> the menu icon ①. The menu screen displays.</p>  
2.	<p><b>Touch</b> the “Info” icon ②. The “System Info” screen displays.</p> <p><b>Scroll</b> to view the oven model, serial number, software version, and system information.</p>  

## Result

The oven’s information has been viewed.

# How to Download HACCP Data

## Before you begin

### Make sure:

- The oven is on, but not in a cooking mode.
- You will need a USB drive.

## Background

HACCP data provides automated record keeping, set-point validation, recipes used, dates and times. The data is stored until the information is downloaded. Once downloaded, the information is removed from the oven's memory. Best practice would be to download the information every 30 days to a USB drive. The file format is plain text file (.csv). The file can be viewed in Microsoft® Excel.

## Procedure

To download HACCP data, do the following.

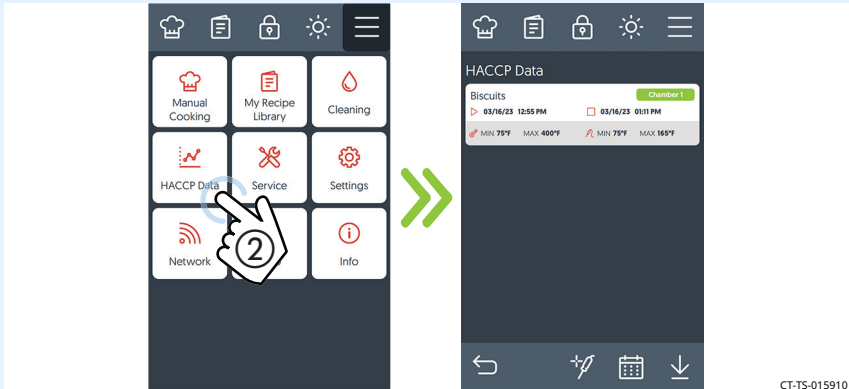
Step	Action
1.	<p><b>Touch</b> the menu icon ①. The menu screen displays.</p>  <p style="text-align: right;">CT-TS-014429</p>
2.	<p><b>Touch</b> the "HACCP Data" icon ②. The "HACCP Data" screen displays.</p>  <p style="text-align: right;">CT-TS-015910</p>

*Continued on next page*

Continued from previous page

3. **Plug** the USB drive ③ into the port.

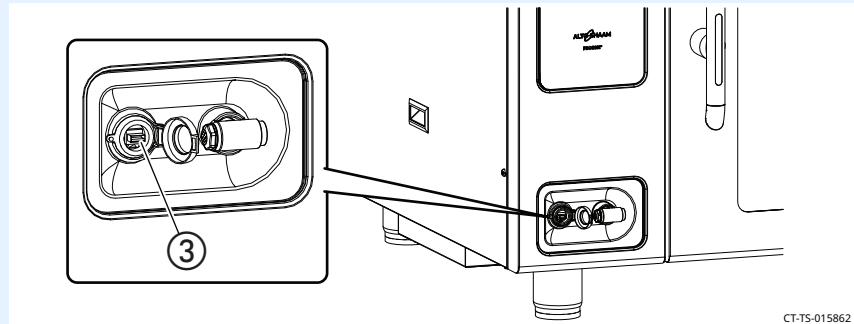

4. **Touch** the download icon ④.

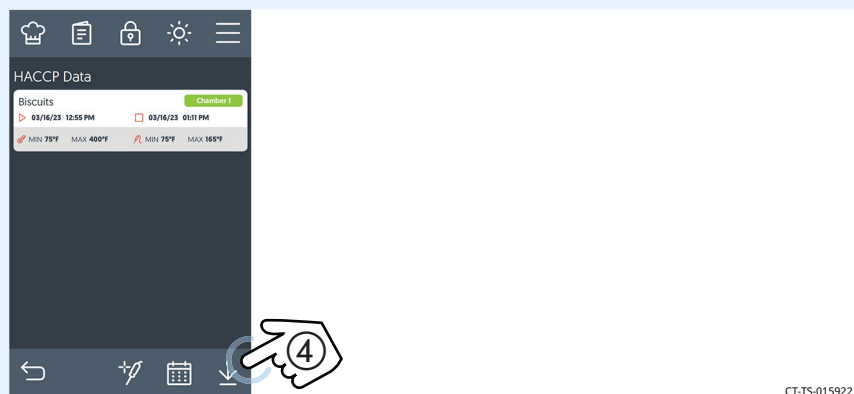

## Loading the data

The oven downloads the data onto the USB drive. When the process is complete, the “Download Successful” screen displays. **Touch** the check mark to return to the menu screen. **Remove** the USB drive.

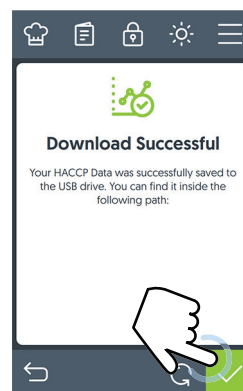

## Result

The HACCP data has now been downloaded.

# How to Calibrate the Temperature Probe

## Before you begin

### Make sure:

- The oven is on, but not in cooking mode.
- You have a thermometer.
- You have a container filled with ice and water.

## Procedure

To calibrate the probe, do the following.

Step	Action
1.	<b>Insert</b> the probe and the thermometer in a container of ice water and allow the temperature to settle to 32°F (0°C).
2.	<b>Touch</b> the menu icon ①. The menu screen displays.
3.	<b>Touch</b> the “HACCP Data” icon ②. The “HACCP Data” screen displays.

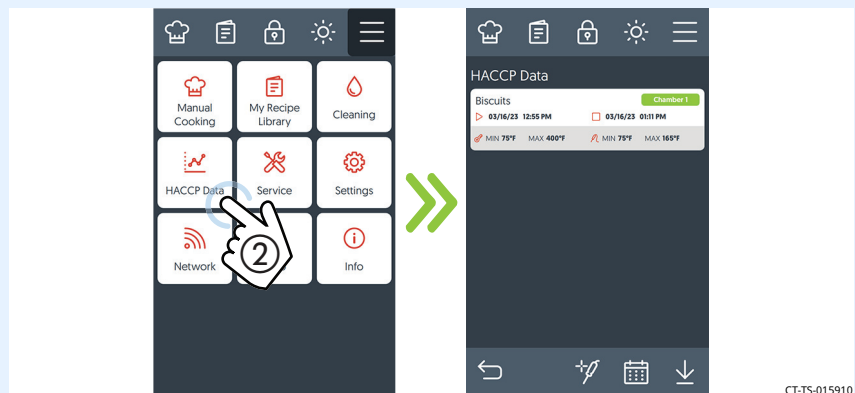
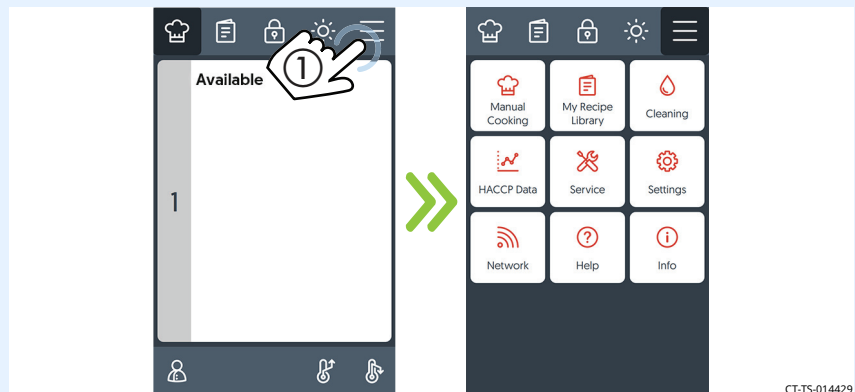

*Continued on next page*

Continued from previous page

4. **Touch** the calibrate probes icon ③.

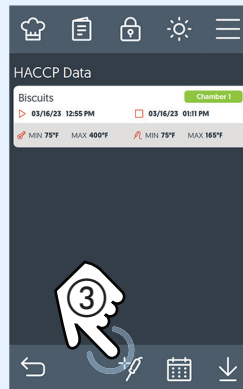

CT-TS-015913

5. **Compare** the probe temperature reading against 32°F (0°C).  
**Touch** the "+" or "-" symbols ④ until the temperature displayed is 32°F (0°C).

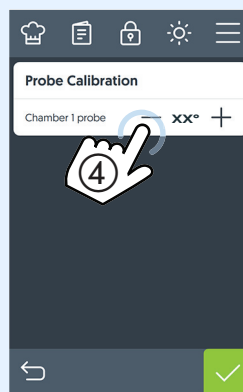

CT-TS-015916

6. **Remove** the probe from the ice water.

## Result

The probe is now calibrated.

This page is intentionally left blank.

# Maintenance Schedule

## Requirements

- See topic *How to Clean the Oven*.
- Make sure the oven is cooled down and off—inside of chamber 140°F (60°C) or less.

## Daily

For daily maintenance, do the following.

- **Remove** any spills with disposable paper wipes or a damp cloth.
- **Wipe** the outside of the oven with a damp cloth.
- **Wipe** the oven gaskets with soap and water.
- **Inspect** the oven gaskets for damage.
- **Wipe** the front door glass.
- **Check** the product probe.
- **Check** the screen for cracking or peeling. Contact Technical Service if needed.

## Weekly

For weekly maintenance, do the following.

- **Clean** the entire oven. **Make sure** to use a non-abrasive nylon scrub pad.
- Do not spray the cleaner directly into the fan openings located in the rear of the oven.
- **Inspect** the door LEDs.
- **Inspect** the oven cavity for signs of grease/carbon buildup.
- **Check** behind the fan panel inside the oven cavity for signs of grease/carbon buildup.
- **Check** behind the fan panel inside the oven cavity for signs of scale buildup.
- **Inspect** the heat exchanger for any signs of major deformation. If yes, immediately remove from service and take corrective action.
- **Inspect** the heat exchanger for any loose/disconnected pipes or flanges. If yes, immediately remove from service and take corrective action.
- **Inspect** the convection elements for signs of cracking, deformation, or damage.
- **Clean** the ventless hood grease filters (if ventless hood is equipped).

## Monthly

For monthly maintenance, do the following.

- **Clean** out the drip tray line.
- **Check** the supplied water filtration and change as needed.
- **Check** for software updates.
- **Inspect** and test the proper draining of the oven cavity.
- **Inspect** the drain lines for leaks or clogs.

*Continued on next page*

*Continued from previous page*

- **Inspect** the oven cavity for any signs of scale buildup.
- **Inspect** the ventless hood paper filter (if ventless hood is equipped, replace as needed).
- **Test** the ventless hood drain for proper drainage and signs of leaking.
- De-scale as needed. See topic *How to Descale the Oven*.

## Yearly

For yearly maintenance, do the following.



**NOTE:** Must be performed by a qualified professional.

- **Replace** the steam bypass hose.
- **Inspect** and test the humidity control.
- **Inspect** all drain hoses and clamps.
- **Inspect** all steam water injection lines and clamps for leaks or potential issues.
- **Inspect** wiring to heating elements. Re-tighten or secure as needed. Record the amp draw.
- **Inspect** the cleaning system pump and hoses for leaks and proper operation.
- **Inspect** and test the proper draining of the oven cavity.
- **Inspect** the upper browning valve hose.
- **Inspect** the low pressure relief valve and hose.
- **Inspect** the convection element seal from the electrical compartment.
- **Inspect** the gas heat exchanger seal from the electrical compartment.
- **Inspect** the N6 oven temperature probe seal.
- **Inspect** the hand shower handle and hose.
- **Check** operation of all electrical cooling fans.
- **Test** steam injection solenoid.
- **Test** condensate solenoid.
- **Check** all electrical connections are properly connected and secure to the boards.
- **Check** door hinges and handles. Tighten, secure, or adjust as needed.
- **Check** door gaskets for damage and seal.
- **Run** the oven in convection mode and test operation.
- **Run** the oven in steam mode and test operation.
- De-scale as needed.



# How to Clean the Oven using Cleaning Tablets

## Precautions



**WARNING:** Burn hazard.

Wear protective gloves, protective clothing, eye protection, and face protection when handling oven cleaner. Do not open the oven door during the cleaning cycle.

**NOTICE**

Do not use steel pads, wire brushes, or scrapers when cleaning.

## Background

The oven has five different cleaning modes.

- The rinse cycle (10 minutes).
- The light clean cycle (35 minutes).
- The medium clean (1 hour and 18 minutes).
- The heavy clean (2 hours and 5 minutes).
- The heavy plus clean (3 hours and 30 minutes).

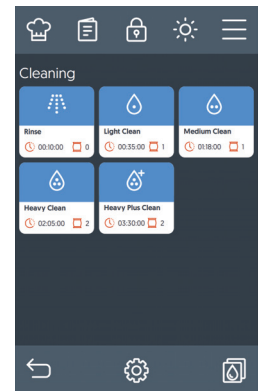

CT-TS-014487

## Cleaning the oven

To clean the oven, do the following.

Step	Action
1.	<b>Clean</b> the door glass with Windex® or equivalent glass cleaner.
2.	<b>Clean</b> the door gasket with soap and water.
3.	<p><b>Close</b> the door.</p> <p><b>Spray</b> the exterior of the oven with stainless steel polish. <b>Wipe</b> the exterior of the oven with a non-abrasive scrub pad. Follow safety instructions on the bottle of the stainless steel polish.</p>
	<p><b>NOTICE</b> Use only non-caustic cleaners.</p> <p>Do not spray directly into the fan openings on the rear of the oven.</p> <p>Do not use cleaners that contain sodium hydroxide (lye) or phosphorus.</p>

*Continued on next page*

Continued from previous page

4. **Touch** the menu icon ①. The menu screen displays.



5. **Touch** the "Cleaning" icon ②. The Cleaning screen displays.

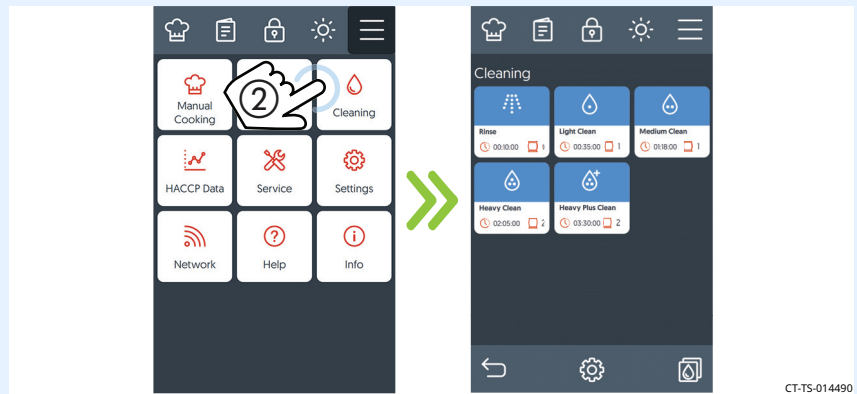

Continued on next page

Continued from previous page

6. **Select** the desired cleaning level, for example Heavy Clean ③.

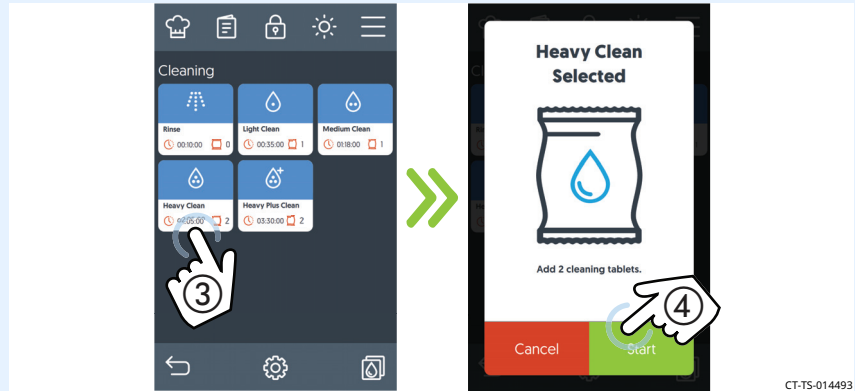

**Insert** the appropriate number of cleaning tablets into the drain.

**Close** the drain screen.

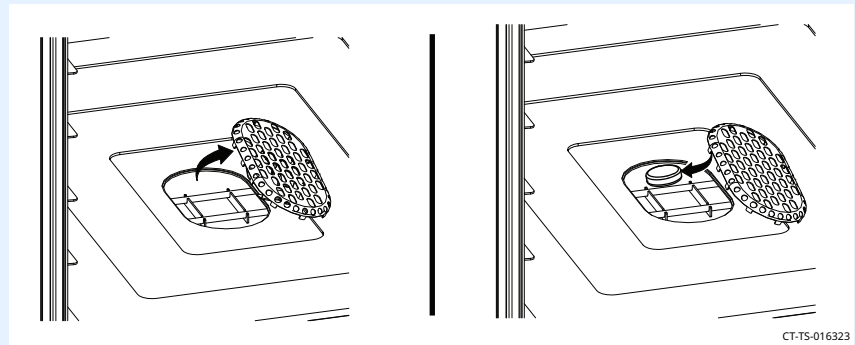

**Touch** the "Start" icon ④.

7. The oven heats to the required temperature for the cleaning cycle, then the cleaning cycle starts.

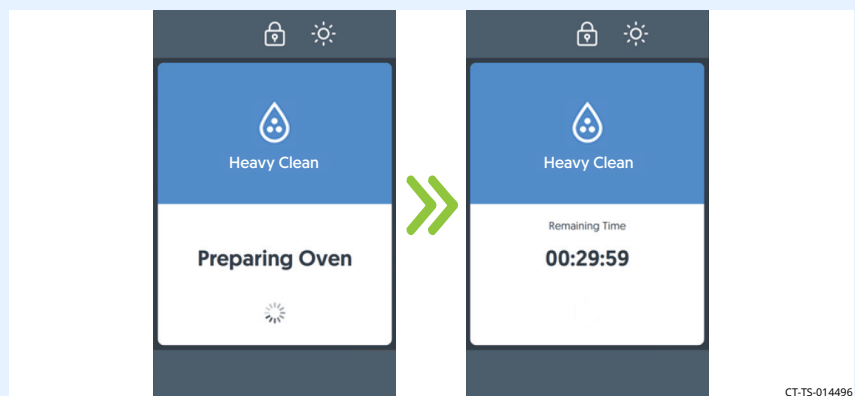

Continued on next page

Continued from previous page

8. **Touch "Ok" ⑤** when the cleaning cycle is complete.



**WARNING:** Burn hazard.

Open the door carefully when the cleaning cycle is complete. Escaping hot vapors or steam can cause injury.

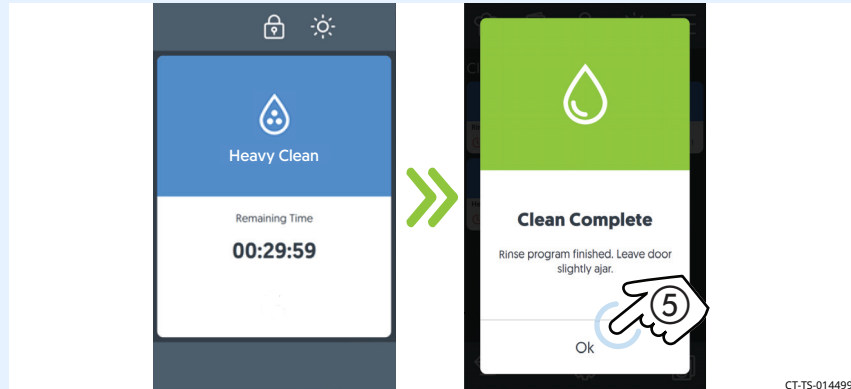

9. **Leave** the door slightly ajar if the cleaning has been done at the end of the day.

**Result**

The oven is now clean.

# How to Clean the Oven using Liquid Clean (if equipped)

## Precautions



**WARNING:** Burn hazard.

Wear protective gloves, protective clothing, eye protection, and face protection when handling oven cleaner. Do not open the oven door during the cleaning cycle.



**WARNING:** Fire hazard.

Do not operate the oven in a cleaning mode without the liquid cleaner connected, with a kink in the cleaning hose line, or with an empty liquid cleaner container. Failure to do so may result in poor oven cleaning, grease and/or carbon accumulating inside the oven cavity and increased risk of fire.

**NOTICE**

Do not use steel pads, wire brushes, or scrapers when cleaning.

## Background

The oven has five different cleaning modes.

- The rinse cycle (10 minutes).
- The light clean cycle (30 minutes).
- The medium clean (1 hour and 20 minutes).
- The heavy clean (2 hours and 6 minutes).
- The heavy plus clean (3 hours and 30 minutes).

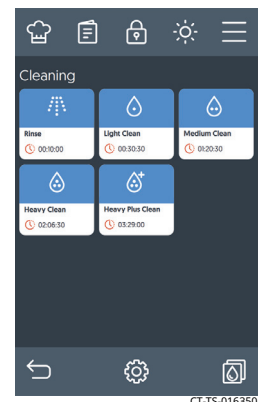

*Continued on next page*

Continued from previous page

## Cleaning the oven

To clean the oven, do the following.

Step	Action
1.	<b>Clean</b> the door glass with Windex® or equivalent glass cleaner.
2.	<b>Clean</b> the door gasket with soap and water.
3.	<p><b>Close</b> the door.</p> <p><b>Spray</b> the exterior of the oven with stainless steel polish. <b>Wipe</b> the exterior of the oven with a non-abrasive scrub pad. Follow safety instructions on the bottle of the stainless steel polish.</p>

**NOTICE** Use only non-caustic cleaners.  
 Do not spray directly into the fan openings on the rear of the oven.  
 Do not use cleaners that contain sodium hydroxide (lye) or phosphorus.

4. **Touch** the menu icon ①. The menu screen displays.



CT-TS-014429

5. **Touch** the “Cleaning” icon ②. The Cleaning screen displays.

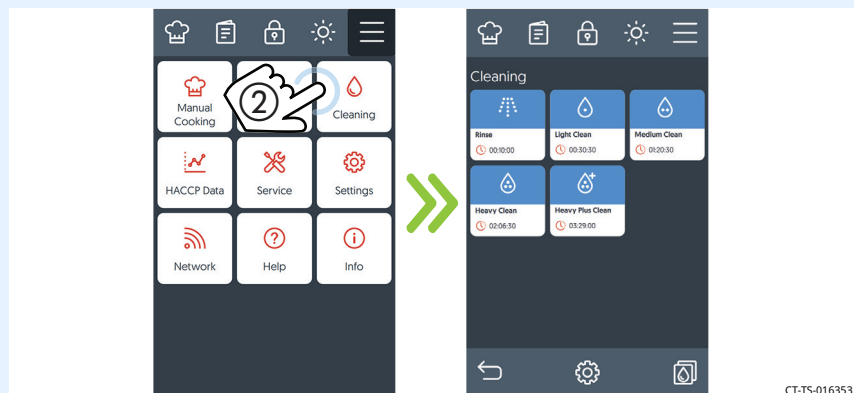

CT-TS-016353

Continued on next page

Continued from previous page

6. **Select** the desired cleaning level, for example Heavy Plus Clean ③.

7. **Touch** "Continue" ④, then **touch** "Start".

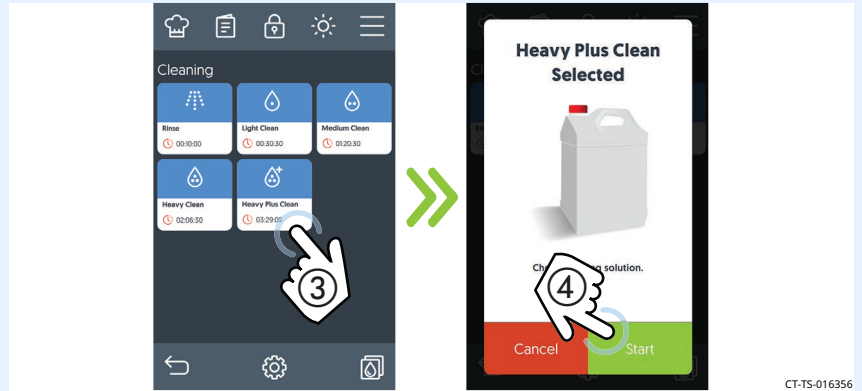

8. The oven heats to the required temperature for the cleaning cycle, then the cleaning cycle starts.

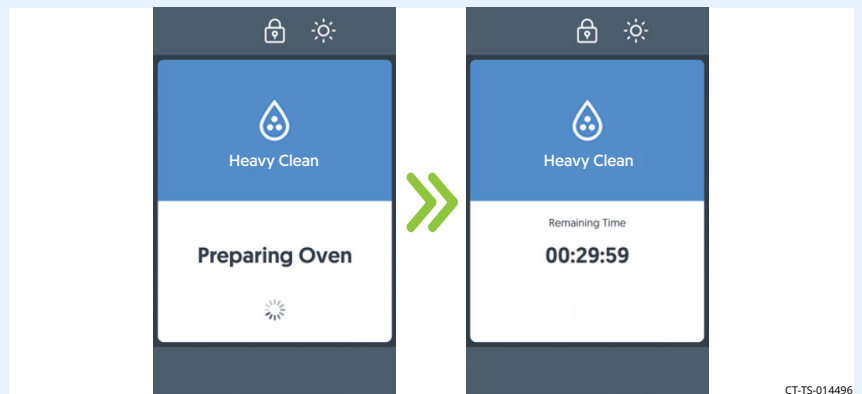

Continued on next page

Continued from previous page

9. **Touch "Ok" ⑤** when the cleaning cycle is complete.



**WARNING:** Burn hazard.

Open the door carefully when the cleaning cycle is complete. Escaping hot vapors or steam can cause injury.

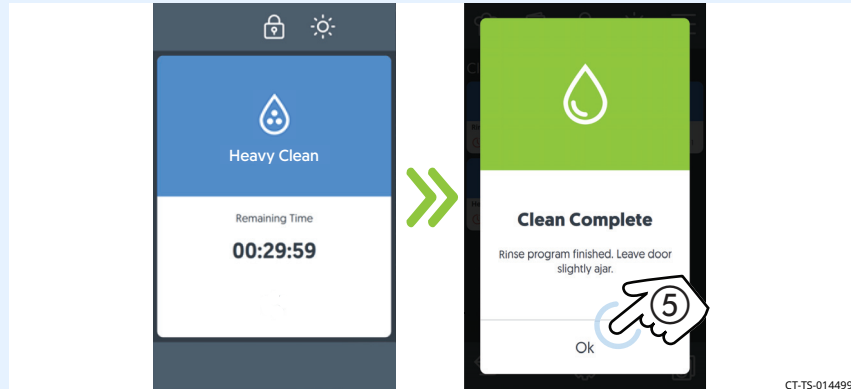

10. **Leave** the door slightly ajar if the cleaning has been done at the end of the day.

**Result**

The oven is now clean.



# How to Descale the Oven

## Before you begin



**WARNING:** Burn hazard.

Wear protective gloves, protective clothing, eye protection, and face protection when handling oven cleaner. Do not open the oven door during the wash or rinse cycle.

### NOTICE

Do not use steel pads, wire brushes, or scrapers when cleaning.

**Make sure** you have Alto-Shaam ScaleFree Descaling Powder (CE-27889).

## Procedure

To descale the oven, do the following.

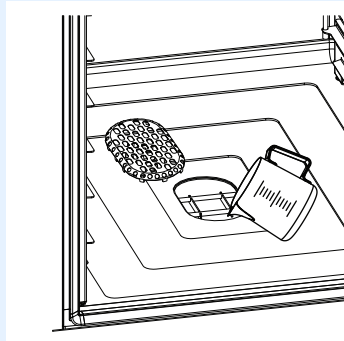
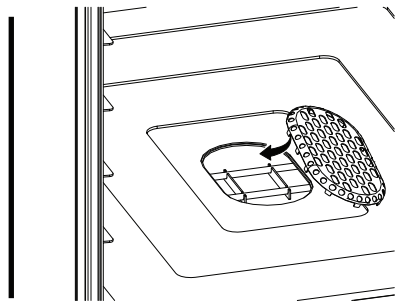
Step	Action
1.	<p><b>Place</b> 7 oz. (198 g) of Alto-Shaam ScaleFree Descaling Powder into the cavity drain.</p> <p><b>Close</b> the drain screen.</p>   <p style="text-align: right; font-size: small;">CT-TS-016419</p>
2.	<b>Disconnect</b> the liquid cleaner hose, if equipped.
3.	<b>Clean</b> the oven with a heavy clean cycle. See topic <i>How to Clean the Oven Using Cleaning Tablets</i> or <i>How to Clean the Oven Using Liquid Cleaner</i> .
4.	<b>Spray</b> the interior of the oven using the hand shower.
5.	<b>Open</b> the interior fan guard and rinse down the area behind the panel.
6.	<b>Run</b> a rinse cycle.

## Result

The oven is now descaled.

# How to View the Cleaning Log

**Background**

The cleaning log allows the user to view details about the previously completed cleaning cycles on the unit.

**Procedure**

To view the cleaning log, do the following.

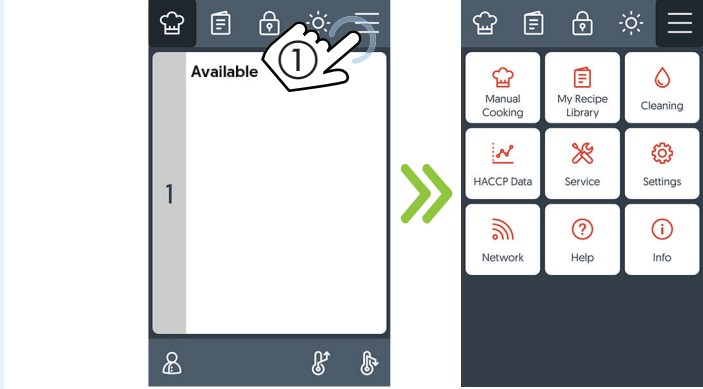
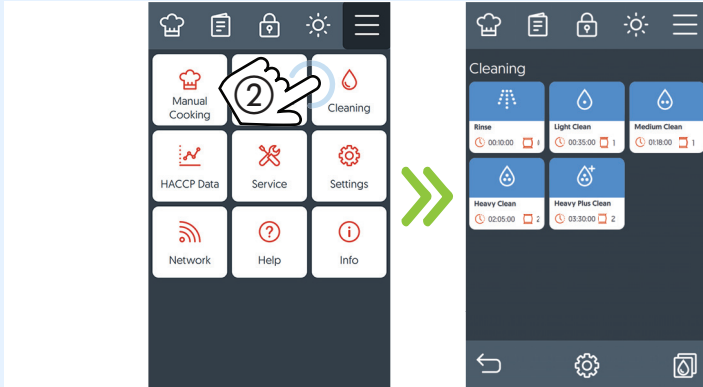
Step	Action
1.	<p><b>Touch</b> the menu icon ①. The menu screen displays.</p>  <p style="text-align: right;">CT-TS-014429</p>
2.	<p><b>Touch</b> the "Cleaning" icon ②. The "Cleaning" screen displays.</p>  <p style="text-align: right;">CT-TS-014490</p>

*Continued on next page*

Continued from previous page

3. **Touch** the cleaning log icon ③. The “Cleaning log” screen displays.



**Result**

The cleaning log has been viewed.

# How to Set the Cleaning Time

**Background**

The user can set a cleaning frequency to schedule when the unit will go through a cleaning cycle. The cleaning frequency can be set by hours or day and time.

**Procedure**

To set the cleaning time, do the following.

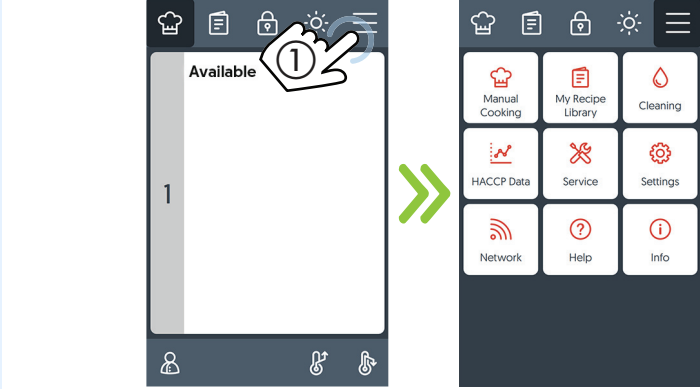
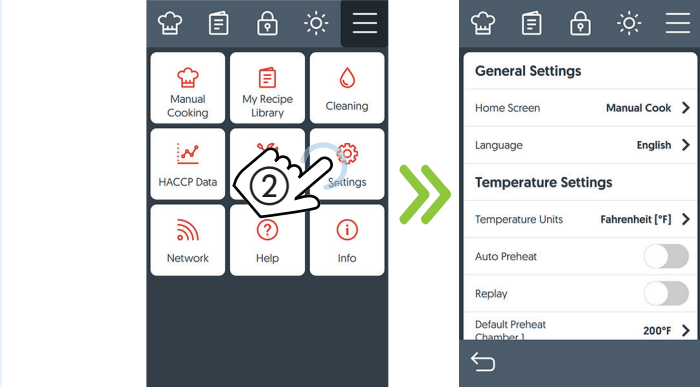
Step	Action
1.	<p><b>Touch</b> the menu icon ①. The menu screen displays.</p>  <p>The screenshot shows the main menu screen with a grid of icons: Manual Cooking, My Recipe Library, Cleaning, HACCP Data, Service, Settings, Network, Help, and Info. A hand icon with a circled '1' is pointing to the menu icon (three horizontal lines) in the top right corner. A green arrow points to the right, indicating the next screen.</p>
2.	<p><b>Touch</b> the "Settings" icon ②. The "General Settings" screen displays.</p>  <p>The screenshot shows the 'General Settings' screen with various options: Home Screen (Manual Cook), Language (English), Temperature Settings (Fahrenheit [°F]), Auto Preheat (toggle off), Replay (toggle off), and Default Preheat Chamber 1 (200°F). A hand icon with a circled '2' is pointing to the 'Settings' icon in the previous screen's grid. A green arrow points to the right, indicating the next screen.</p>

*Continued on next page*

Continued from previous page

3. **Scroll** ③ until “Cleaning Settings” displays. **Touch** the “Set Cleaning Frequency” ④ setting.

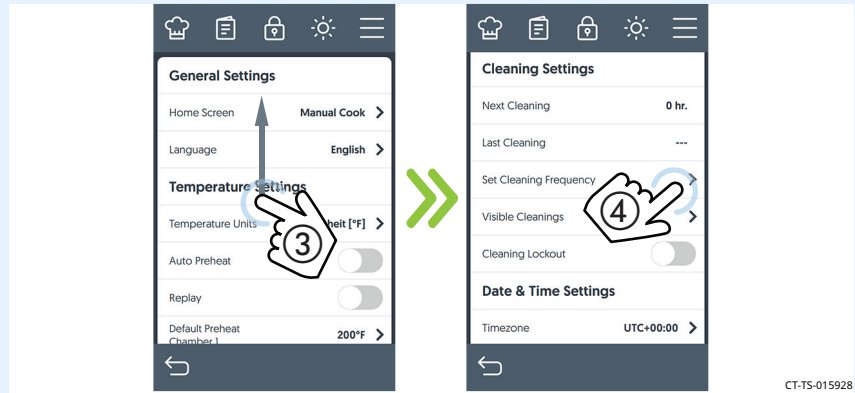

CT-TS-015928

### Setting the cleaning frequency hours

4. **Touch** the “Hours” setting ⑤ to set the cleaning frequency hours. **Enter** the desired hours using the key pad. **Touch** the check mark.

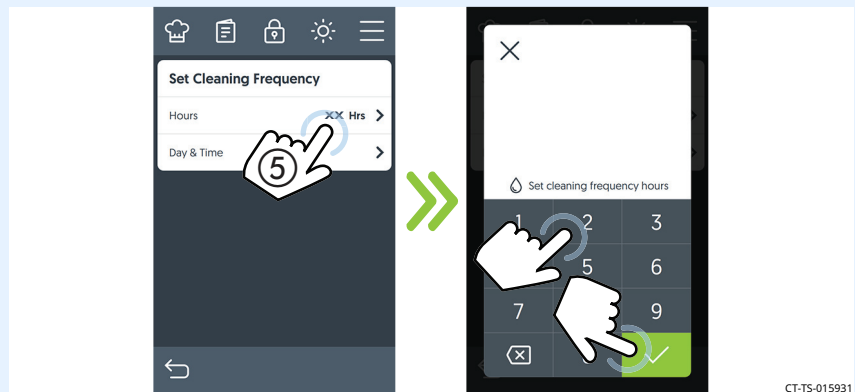

CT-TS-015931

### Setting the cleaning frequency day and time

5. **Touch** the “Date & Time” setting ⑥ to set the day and time for cleaning. **Touch** the check box ⑦ next to a day to set it. **Touch** the check mark.

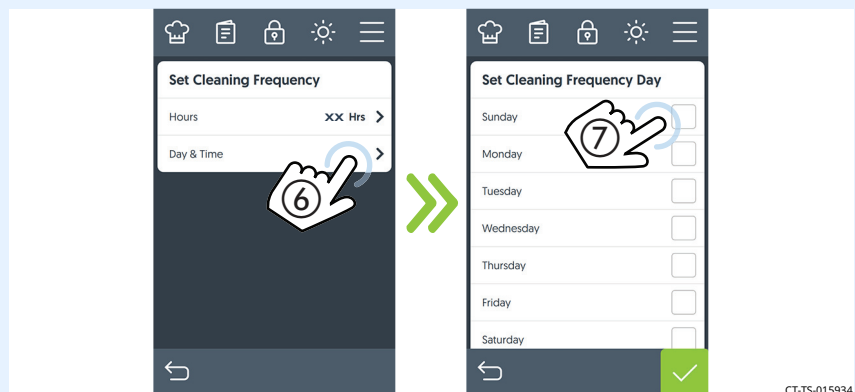

CT-TS-015934

Continued on next page

Continued from previous page

6. The “Set cleaning frequency time” screen will display.  
**Touch** the “AM”/”PM” button ⑧ to choose whether the cleaning time is set for AM or PM.  
**Enter** the time of day for the cleaning. **Touch** the check mark.  
**Touch** the check mark on the “Set Cleaning Frequency” setting screen.

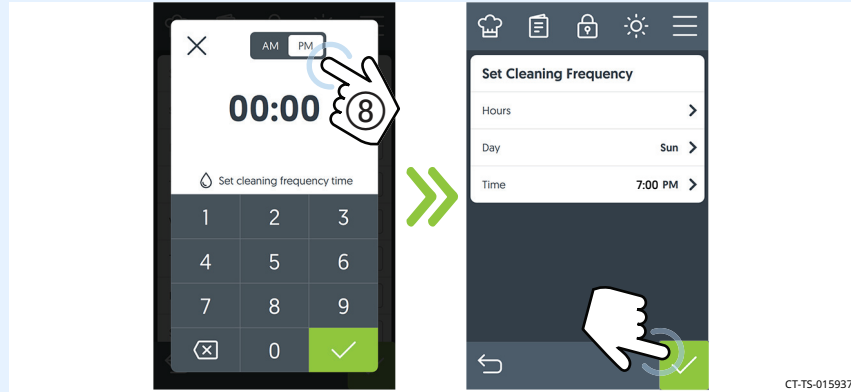

CT-TS-015937

**Result**

The cleaning frequency has been set.

# How to Winterize the Oven

## Winterization

Winterization is required if the Combitherm oven is stored in a location where the ambient temperature falls below 32°F (0°C). Freezing temperatures can permanently damage internal components, especially if water is not completely drained from the unit before storage.

## Winterize the oven

To winterize the oven, do the following.

Step	Action
1.	Allow the oven to cool.
2.	<b>Drain</b> all hoses, solenoids, and tanks (condensate and pump housing).
3.	<b>Flush</b> RV antifreeze through the tanks and hoses.
<div style="display: flex; align-items: center;">  <div style="margin-left: 20px;"> <p><b>WARNING:</b> Poison hazard. Use only RV antifreeze specifically intended for potable water systems. Flush system thoroughly as directed before putting back into use.</p> </div> </div>	
4.	<b>Inspect</b> all hoses, and components connected to hoses, for signs or cracking or splitting.
5.	<b>Flush</b> cold water through each hose and each solenoid for a minimum of two minutes.
6.	<b>Spray</b> cold water directly into oven cavity drain for a minimum of two minutes.
<div style="display: flex; align-items: center;"> <div style="border-left: 2px solid blue; padding-left: 10px;"> <p><b>NOTICE</b></p> </div> <div style="margin-left: 10px;"> <p>Do not use pressurized water for this step. Use only the oven's hand shower.</p> </div> </div>	
7.	<b>Run</b> a forced rinse cycle.
8.	<b>Inspect</b> drained water to verify all RV antifreeze has been flushed through all hoses and tanks.
9.	<b>Run</b> a 30-minute steam cycle and 30-minute clean cycle.

## Restart the oven

## Result

The oven is now ready for operation.

This page is intentionally left blank.



# Error Codes

Code	Component	Description	Troubleshooting steps
E-5	2 - Convection fan	Convection fan (upper) under speed	<ol style="list-style-type: none"> <li>1. Power down control using on/off icon.</li> <li>2. Cycle power to the oven either by unplugging the unit or by turning the main power switch off and then back on.</li> <li>3. Resume use of oven. If error reappears contact a service provider.</li> </ol>
E-5	2 - Convection fan	Lower convection fan under speed	<ol style="list-style-type: none"> <li>1. Power down control using on/off icon.</li> <li>2. Cycle power to the oven either by unplugging the unit or by turning the main power switch off and then back on.</li> <li>3. Resume use of oven. If error reappears contact a service provider.</li> </ol>
E-10	44 - Cavity sensor	Cavity sensor short	<ol style="list-style-type: none"> <li>1. Power down control using on/off icon.</li> <li>2. Cycle power to the oven either by unplugging the unit or by turning the main power switch off and then back on.</li> <li>3. Resume use of oven. If error reappears contact a service provider.</li> </ol>
E-10	47 - Food probe	Food probe short	<ol style="list-style-type: none"> <li>1. Investigate food probe for damage. Replace if damaged.</li> <li>2. Power down control using on/off icon.</li> <li>3. Cycle power to the oven either by unplugging the unit or by turning the main power switch off and then back on.</li> <li>4. Resume use of oven. If error reappears contact a service provider.</li> </ol>
E-10	52 - Steam injector	Steam injector sensor short	<ol style="list-style-type: none"> <li>1. Power down control using on/off icon.</li> <li>2. Cycle power to the oven either by unplugging the unit or by turning the main power switch off and then back on.</li> <li>3. Resume use of oven. If error reappears contact a service provider.</li> </ol>
E-10	55 - Tank	Tank sensor short	<ol style="list-style-type: none"> <li>1. Power down control using on/off icon.</li> <li>2. Cycle power to the oven either by unplugging the unit or by turning the main power switch off and then back on.</li> <li>3. Resume use of oven. If error reappears contact a service provider.</li> </ol>
E-11	44 - Cavity sensor	Cavity sensor open	<ol style="list-style-type: none"> <li>1. Power down control using on/off icon.</li> <li>2. Cycle power to the oven either by unplugging the unit or by turning the main power switch off and then back on.</li> <li>3. Resume use of oven. If error reappears contact a service provider.</li> </ol>

Code	Component	Description	Troubleshooting steps
E-11	52 - Steam injector	Steam injector sensor open	<ol style="list-style-type: none"> <li>1. Power down control using on/off icon.</li> <li>2. Cycle power to the oven either by unplugging the unit or by turning the main power switch off and then back on.</li> <li>3. Resume use of oven. If error reappears contact a service provider.</li> </ol>
E-11	55 - Tank	Tank sensor open	<ol style="list-style-type: none"> <li>1. Power down control using on/off icon.</li> <li>2. Cycle power to the oven either by unplugging the unit or by turning the main power switch off and then back on.</li> <li>3. Resume use of oven. If error reappears contact a service provider.</li> </ol>
E-31	2 - Convection fan (Classic control)	Motor (upper) over temperature	<ol style="list-style-type: none"> <li>1. Power down control using on/off icon.</li> <li>2. Cycle power to the oven either by unplugging the unit or by turning the main power switch off and then back on.</li> <li>3. Resume use of oven. If error reappears contact a service provider.</li> </ol>
E-31	2 - Convection fan (Classic control)	Lower motor over temperature	<ol style="list-style-type: none"> <li>1. Power down control using on/off icon.</li> <li>2. Cycle power to the oven either by unplugging the unit or by turning the main power switch off and then back on.</li> <li>3. Resume use of oven. If error reappears contact a service provider.</li> </ol>
E-31	2 - Convection fan	Motor VFD (upper) over temperature	<ol style="list-style-type: none"> <li>1. Make sure cooling fan(s) are operating.</li> <li>2. Make sure exhaust vents are clean and free of debris.</li> <li>3. Make sure oven clearances are met.</li> <li>4. Ambient temperature greater than 105°F (41°C).</li> </ol>
E-31	2 - Convection fan	Lower motor VFD over temperature	<ol style="list-style-type: none"> <li>1. Make sure cooling fan(s) are operating.</li> <li>2. Make sure exhaust vents are clean and free of debris.</li> <li>3. Make sure oven clearances are met.</li> <li>4. Ambient temperature greater than 105°F (41°C).</li> </ol>
E-31	44 - Cavity sensor	Chamber over temperature	<ol style="list-style-type: none"> <li>1. If the oven has experienced an over temperature condition allow the oven to cool down for a minimum of 30 minutes.</li> <li>2. Press the high limit reset button.</li> <li>3. Resume cooking operation. If error reappears contact service provider.</li> </ol>
E-31	55 - Tank	Tank sensor over temperature	<ol style="list-style-type: none"> <li>1. If the oven has experienced an over temperature condition allow the oven to cool down for a minimum of 30 minutes.</li> <li>2. Press the high limit reset button.</li> <li>3. Resume cooking operation. If error reappears contact service provider.</li> </ol>

Code	Component	Description	Troubleshooting steps
E-31	8 - Control Board	Control board too warm	<ol style="list-style-type: none"> <li>1. Make sure cooling fan(s) are operating.</li> <li>2. Make sure exhaust vents are clean and free of debris.</li> <li>3. Make sure oven clearances are met.</li> <li>4. Ambient temperature greater than 105°F (41°C).</li> <li>5. Check the door gasket for damage and proper seal.</li> </ol>
E-31	9 - Interface Board	Interface board too warm	<ol style="list-style-type: none"> <li>1. Make sure cooling fan(s) are operating.</li> <li>2. Make sure exhaust vents are clean and free of debris.</li> <li>3. Make sure oven clearances are met.</li> <li>4. Ambient temperature greater than 105°F (41°C).</li> <li>5. Check the door gasket for damage and proper seal.</li> </ol>
E-44	8 - Control Board	Control board SPI bus warning	<ol style="list-style-type: none"> <li>1. Touch screen to acknowledge error</li> <li>2. Continue to use equipment</li> <li>3. Cycle equipment power before attempting to update software</li> <li>4. If error continues, contact service</li> </ol>
E-55	56 - Vent valve	Vent (upper) not open	<ol style="list-style-type: none"> <li>1. Power down control using on/off icon.</li> <li>2. Cycle power to the oven either by unplugging the unit or by turning the main power switch off and then back on.</li> <li>3. Resume use of oven. If error reappears contact a service provider.</li> </ol>
E-55	56 - Vent valve	Lower vent valve not open	<ol style="list-style-type: none"> <li>1. Power down control using on/off icon.</li> <li>2. Cycle power to the oven either by unplugging the unit or by turning the main power switch off and then back on.</li> <li>3. Resume use of oven. If error reappears contact a service provider.</li> </ol>
E-62	2 - Convection fan	Motor VFD (upper) over current	<ol style="list-style-type: none"> <li>1. Power down control using on/off icon.</li> <li>2. Cycle power to the oven either by unplugging the unit or by turning the main power switch off and then back on.</li> <li>3. Resume use of oven. If error reappears contact a service provider.</li> </ol>
E-62	2 - Convection fan	Lower motor VFD over current	<ol style="list-style-type: none"> <li>1. Power down control using on/off icon.</li> <li>2. Cycle power to the oven either by unplugging the unit or by turning the main power switch off and then back on.</li> <li>3. Resume use of oven. If error reappears contact a service provider.</li> </ol>
E-66	2 - Convection fan	VFD (upper) error	<ol style="list-style-type: none"> <li>1. Power down control using on/off icon.</li> <li>2. Cycle power to the oven either by unplugging the unit or by turning the main power switch off and then back on.</li> <li>3. Resume use of oven. If error reappears contact a service provider.</li> </ol>

Code	Component	Description	Troubleshooting steps
E-66	2 - Convection fan	Lower VFD error	<ol style="list-style-type: none"> <li>1. Power down control using on/off icon.</li> <li>2. Cycle power to the oven either by unplugging the unit or by turning the main power switch off and then back on.</li> <li>3. Resume use of oven. If error reappears contact a service provider.</li> </ol>
E-78	19 - Voltage sensor	Voltage monitor too low	<ol style="list-style-type: none"> <li>1. Check to make sure the unit plug is fully seated in the electrical outlet.</li> <li>2. Reset the main circuit breaker for the oven. If error reappears contact service provider.</li> </ol>
E-78	2 - Convection fan	VFD (upper) under voltage	<ol style="list-style-type: none"> <li>1. Check to make sure the unit plug is fully seated in the electrical outlet.</li> <li>2. Reset the main circuit breaker for the oven. If error reappears contact service provider.</li> </ol>
E-78	2 - Convection fan	Lower VFD under voltage	<ol style="list-style-type: none"> <li>1. Check to make sure the unit plug is fully seated in the electrical outlet.</li> <li>2. Reset the main circuit breaker for the oven. If error reappears contact service provider.</li> </ol>
E-79	19 - Voltage sensor	Voltage monitor too high	<ol style="list-style-type: none"> <li>1. Check to make sure the unit plug is fully seated in the electrical outlet.</li> <li>2. Reset the main circuit breaker for the oven. If error reappears contact service provider.</li> </ol>
E-79	2 - Convection fan	VFD (upper) over voltage	<ol style="list-style-type: none"> <li>1. Check to make sure the unit plug is fully seated in the electrical outlet.</li> <li>2. Reset the main circuit breaker for the oven. If error reappears contact service provider.</li> </ol>
E-79	2 - Convection fan	Lower VFD over voltage	<ol style="list-style-type: none"> <li>1. Check to make sure the unit plug is fully seated in the electrical outlet.</li> <li>2. Reset the main circuit breaker for the oven. If error reappears contact service provider.</li> </ol>
E-80	2 - Convection fan	VFD (upper) memory error	<ol style="list-style-type: none"> <li>1. Power down control using on/off icon.</li> <li>2. Cycle power to the oven either by unplugging the unit or by turning the main power switch off and then back on.</li> <li>3. Resume use of oven. If error reappears contact a service provider.</li> </ol>
E-80	2 - Convection fan	Lower VFD memory error	<ol style="list-style-type: none"> <li>1. Power down control using on/off icon.</li> <li>2. Cycle power to the oven either by unplugging the unit or by turning the main power switch off and then back on.</li> <li>3. Resume use of oven. If error reappears contact a service provider.</li> </ol>

Code	Component	Description	Troubleshooting steps
E-88	1 - Heater	Gas ignition failure (upper)	<ol style="list-style-type: none"> <li>1. Power down control using on/off icon.</li> <li>2. Cycle power to the oven either by unplugging the unit or turning off the breaker.</li> <li>3. Inspect the top of oven for anything blocking the exhaust flue of the oven.</li> <li>4. Make sure the ventilation hood is turned on and working properly.</li> <li>5. Make sure the gas line is properly connected to the unit and the gas shut off valve is in the open position.</li> <li>6. Resume cook operation. If error reappears turn the oven off, shut off the gas supply to the oven and immediately contact service provider.</li> </ol>
E-88	1 - Heater	Lower gas ignition failure	<ol style="list-style-type: none"> <li>1. Power down control using on/off icon.</li> <li>2. Cycle power to the oven either by unplugging the unit or turning off the breaker.</li> <li>3. Inspect the top of oven for anything blocking the exhaust flue of the oven.</li> <li>4. Make sure the ventilation hood is turned on and working properly.</li> <li>5. Make sure the gas line is properly connected to the unit and the gas shut off valve is in the open position.</li> <li>6. Resume cook operation. If error reappears turn the oven off, shut off the gas supply to the oven and immediately contact service provider.</li> </ol>
E-90	1 - Heater	Gas blower failure (upper)	<ol style="list-style-type: none"> <li>1. Power down control using on/off icon.</li> <li>2. Cycle power to the oven either by unplugging the unit or by turning the main power switch off and then back on.</li> <li>3. Resume use of oven. If error reappears contact a service provider.</li> </ol>
E-90	1 - Heater	Lower gas blower failure	<ol style="list-style-type: none"> <li>1. Power down control using on/off icon.</li> <li>2. Cycle power to the oven either by unplugging the unit or by turning the main power switch off and then back on.</li> <li>3. Resume use of oven. If error reappears contact a service provider.</li> </ol>
E-93	8 - Control Board	State synchronization error between the interface board and control board	<ol style="list-style-type: none"> <li>1. Clear error by pressing the check mark on the display to accept the error.</li> <li>2. If the error persists contact Alto-Shaam Technical Support.</li> </ol>
E-94	10 - Control Board Communications	Communication error between Interface Board and Control Board	<ol style="list-style-type: none"> <li>1. Power down control using on/off icon.</li> <li>2. Cycle power to the oven either by unplugging the unit or by turning the main power switch off and then back on.</li> <li>3. Resume use of oven. If error reappears contact a service provider.</li> </ol>

Code	Component	Description	Troubleshooting steps
<b>E-94</b>	2 - Convection fan	VFD (upper) communication error	<ol style="list-style-type: none"> <li>1. Power down control using on/off icon.</li> <li>2. Cycle power to the oven either by unplugging the unit or by turning the main power switch off and then back on.</li> <li>3. Resume use of oven. If error reappears contact a service provider.</li> </ol>
<b>E-94</b>	2 - Convection fan	Lower VFD communication error	<ol style="list-style-type: none"> <li>1. Power down control using on/off icon.</li> <li>2. Cycle power to the oven either by unplugging the unit or by turning the main power switch off and then back on.</li> <li>3. Resume use of oven. If error reappears contact a service provider.</li> </ol>
<b>E-102</b>	59 - Ventless hood	Ventless hood filter Fault	<ol style="list-style-type: none"> <li>1. Check if filters are installed.</li> <li>2. Check if filters are clogged.</li> <li>3. Check operation of hood fan.</li> </ol>
<b>E-105</b>	6 - Chamber	Low water pressure	<ol style="list-style-type: none"> <li>1. Water supply not connected.</li> <li>2. Water supply is shut off.</li> <li>3) Water supply to unit blocked or obstructed (check filter).</li> </ol>
<b>E-109</b>	6 - Chamber	Chamber high limit	<ol style="list-style-type: none"> <li>1. If the oven has experienced an over temperature condition, allow the oven to cool down for a minimum of 30 minutes.</li> <li>2. Press the high limit reset button.</li> <li>3. Resume cooking operation. If error reappears contact service provider.</li> </ol>
<b>E-606</b>	6 - Chamber	Error during cleaning cycle	<ol style="list-style-type: none"> <li>1. Manually Clean Oven.</li> <li>2. Manually Rinse Oven.</li> <li>3. Ensure chemicals removed before use.</li> <li>4. Resume use of oven. If error repeats contact service provider.</li> </ol>
<b>E-999</b>	48 - Personality handler	IB and CB dip switch settings not set correctly	<ol style="list-style-type: none"> <li>1. Power down control using on/off icon.</li> <li>2. Cycle power to the oven either by unplugging the unit or by turning the main power switch off and then back on.</li> <li>3. Resume use of oven. If error reappears contact a service provider.</li> </ol>

# Notifications

---

**FCC ID: N6C-SDPAC**

**IC ID: 4908A-SDPAC**

## **NOTICE**

### **Federal Communication Interference Statement (United States only)**

This equipment has been tested and found to comply with the limits for a class B digital device, pursuant to Part 15 of the FCC rules. These limits are designed to provide reasonable protection against harmful interference in a residential installation. This equipment generates, uses, and can radiate radio frequency energy and, if not installed and used in accordance with the instructions, may cause harmful interference to radio communications. However, there is no guarantee that interference will not occur in a particular installation. If this equipment does cause harmful interference to radio or television reception, which can be determined by turning the equipment off and on, the user is encouraged to try to correct the interference by one or more of the following measures:

- Re-orient or relocate the receiving antenna
- Increase the separation between the equipment and receiver
- Connect the equipment to an outlet on a circuit different from that to which the receiver is connected
- Consult the dealer or an experienced radio/TV technician for help

The antenna(s) used for this transmitter must be installed to provide a separation distance of at least 20 cm from all persons and must not be co-located or operating in conjunction with any other antenna or transmitter.

**Canadian Department of Communications Industry Canada Notice  
(Canada only)**

This Class B digital apparatus complies with Canadian ICES-003.

**FCC Rules, Part 15 / Industry Canada**

This device complies with Part 15 of FCC Rules and Industry Canada license-exempt RSS standard(s). Operation is subject to the following two conditions:

- (1) This device may not cause harmful interference, and
- (2) This device must accept any interference, including interference that may cause undesired operation of this device.

This equipment complies with FCC/IC radiation exposure limits set forth for an uncontrolled environment and meets the FCC radio frequency (RF) Exposure Guidelines in Supplement C to OET65 and RSS-102 of the IC radio frequency (RF) Exposure rules. This equipment should be installed and operated keeping the radiator at least 20 cm or more away from a person's body.

Under Industry Canada regulations, this radio transmitter may only operate using an antenna of a type and maximum (or lesser) gain approved for the transmitter by Industry Canada. To reduce potential radio interference to other users, the antenna type and its gain should be so chosen that the equivalent isotropically radiated power (e.i.r.p.) is not more than that necessary for successful communication.

This radio transmitter (identify the device by certification number, or model number if Category II) has been approved by Industry Canada to operate with the antenna types listed below with the maximum permissible gain and required antenna impedance for each antenna type indicated. Antenna types not included in this list, having a gain greater than the maximum gain indicated for that type, are strictly prohibited for use with this device.

For product available in the USA/Canada market, only channels 1–11 can be operated. Selection of other channels is not possible. If this device is to be operated in the 5.15~5.25GHz frequency range, it is restricted to indoor environments only.

Antenna: Proprietary

Antenna gain information: Embedded Antenna: 3.25dBi (2.4 GHz), 5.0dBi (5 GHz)

Frequency Tolerance: +/-20ppm

**WARNING**

The FCC / The Industry Canada regulations provide that changes or modifications not expressly approved by the party responsible for compliance could void the user's authority to operate the equipment.



**General Specifications**

<b>Chipset:</b>	QCA9377-3, (Qualcomm Atheros)
<b>Host Interface:</b>	Wifi: SDIO v3.0; BT: High Speed UART
<b>Operating Voltage:</b>	3.30 VDC +/- 5%
<b>Operating Temperature:</b>	-20 to +70 degrees C
<b>Dimensions:</b>	18.0 x 13.0 x 2.2 mm (L x W x D)
<b>Connector Type:</b>	52-pin proprietary
<b>Radio Specifications:</b>	802.11b/g/n: 2.412–2.484 GHz; 802.11a/n: 5.18–5.825 GHz BT: 2.402–2.480 GHz
<b>Link Rates (1 stream):</b>	IEEE 802.11b: 1–11 Mbps IEEE 802.11g: 6–54 Mbps IEEE 802.11a: 6–54 Mbps IEEE 802.11n HT20: 6.5–65.0 Mbps IEEE 802.11n HT40: 13.5–135.0 Mbps IEEE 802.11ac VHT20: 6.5–78.0 Mbps IEEE 802.11ac VHT40: 13.5–180.0 Mbps IEEE 802.11ac VHT80: 29.3–390.0 Mbps
<b>Modulation Modes:</b>	OFDM (256QAM, 64QAM, 16QAM, QPSK, BPSK), DSSS (CCK, DQPSK, DBPSK), GFSK (1Mbps), $\pi/4$ DQPSK (2Mbps), 8DQPSK (3Mbps)
<b>Hardware Encryption:</b>	WEP, WPA/WPA2 (TKIP/AES-CCMP), WAPI
<b>Quality of Service (QoS):</b>	WMM, WMM-PS, 802.11e
<b>Japanese Security Standard</b>	This oven cannot be connected directly to the telecommunications circuits (or public wireless LANs) of any telecommunication carriers (example: mobile communications carriers, fixed communications carriers, or Internet providers). In the case of connecting the oven to the Internet, make sure to connect it via a router.

# Conditions for Ovens Installed in New York City

---

- Operating instructions in the manual must be read and understood by all persons using the appliance. The person responsible for training of the operators is responsible for the safekeeping of the manual.
- Prior to installation, plans specifying the exact product name/model number and dimensions/specifications shall be filed with and approved by New York City Department of Buildings (DOB). A copy of DOB docketed (Stamped, numbered and dated) plans shall be transmitted to the Fire Department for review and approval, as applicable.
- Installation, maintenance, and cleaning procedures shall comply with all applicable New York City Fire Code, New York City Electric Code, New York City Construction Codes (including the Building Code and the Mechanical Code), and rules.
- The cooking equipment shall be used for light duty cooking and food warming only, and shall be provided with catalyst to limit the emission of grease-laden air.
- The cooking equipment shall be installed in an area approved by the New York City Department of Buildings.
- Underwriters Laboratories, Inc.'s listing requirements and manufacturer's installation, operation and maintenance requirements shall be complied with.
- The cooking equipment (including filters and catalyst) shall be inspected, cleaned and replaced if necessary, by a qualified person holding a Fire Department Certificate of Fitness. The catalyst shall be maintained in proper working order. A record of such inspection and cleaning shall be kept on the premises for inspection.
- All installations are subject to inspection by representatives of the Bureau of Fire Prevention which may result in additional requirements being imposed.
- The Fire Department's condition of approval shall be provided to all New York City buyers, users and installers.
- Certificate of Approval number shall be plainly and permanently stamped or otherwise fixed upon each product by the manufacturer or the local representative of the manufacturer.
- The equipment's technology does not violate any patent, trade name, trade secret or other intellectual right.
- The Certificate of Approval does not constitute an endorsement or recommendation of the product by the Fire Department, but is a certification that the product is acceptable as of the date of issuance.
- The Fire Department may withdraw this approval at any time in the event there is a reasonable doubt that the product does not operate or perform as required by code, the conditions of the resolution or as represented in the application.
- Any end user who fails to comply with the conditions as outlined in this approval will be subject to enforcement action.

# Warranty

## Introduction

Alto-Shaam, Inc. warrants to the original purchaser only, that any original part found to be defective in material or workmanship will be replaced with a new or rebuilt part at Alto-Shaam's option, subject to provisions hereinafter stated.

## Warranty Period

The original parts warranty period is as follows:

- For all other original parts, one (1) year from the date of installation of appliance or fifteen (15) months from the shipping date, whichever occurs first.
- The labor warranty period is one (1) year from the date of installation or fifteen (15) months from the shipping date, whichever occurs first.
- Alto-Shaam will bear normal labor charges performed during standard business hours, excluding overtime, holiday rates or any additional fees.
- For the refrigeration compressor, if installed, the warranty period is five (5) years from the date of original installation of the appliance.
- For heating elements on Halo Heat® Cook and Hold ovens, the warranty period is for as long as the original owner owns the oven. This warranty period applies to units sold after 2/1/2009 and excludes holding-only ovens.
- To be valid, a warranty claim must be asserted during the applicable warranty period. This warranty is not transferable.

## Exclusions

This warranty does not apply to:

- Calibration.
- Replacement of light bulbs, rubber gaskets, grease filters, air filters, racks, jet plates, and/or the replacement of glass due to damage of any kind.
- Equipment damage caused by accident, shipping, improper installation or alteration.
- Equipment used under conditions of abuse, misuse, carelessness or abnormal conditions, including but not limited to, equipment subjected to harsh or inappropriate chemicals, including but not limited to, compounds containing chloride or quaternary salts, poor water quality, or equipment with missing or altered serial numbers.
- Equipment damage caused by use of any cleaning agents other than those recommended by Alto-Shaam, including but not limited to damage due to chlorine or other harmful chemicals.
- Any losses or damage resulting from malfunction, including loss of food product, revenue, or consequential or incidental damages of any kind.
- Equipment modified in any manner from original model, substitution of parts other than factory authorized parts, unauthorized removal of any parts including legs, or unauthorized addition of any parts.

*Continued on next page*

*Continued from previous page*

- Equipment damage incurred as a direct result of poor water quality\*, inadequate maintenance of steam generators and/or surfaces affected by water. Water quality and required maintenance of steam generating equipment is the responsibility of the owner/operator.
  - Equipment damage incurred as a result of not following the required maintenance schedule published in the manuals for the equipment.
- 

## **Conclusion**

This warranty is exclusive and is in lieu of all other warranties, express or implied, including the implied warranties of merchantability and fitness for a particular purpose. No person except an officer of Alto-Shaam, Inc. is authorized to modify this warranty or to incur on behalf of Alto-Shaam any other obligation or liability in connection with Alto-Shaam equipment.

*\*Refer to the product spec sheet for water quality standards.*

# DECLARATION OF CONFORMITY

**Manufacturer:**

Alto-Shaam, Inc.  
W164 N9221 Water Street  
Menomonee Falls, WI 53202-0450  
U.S.A.



**EQUIPMENT TYPE:** Household and Similar Electric Appliances

**EQUIPMENT DESCRIPTION:** Commercial Steam Convection Ovens

**MODEL NUMBER:** CTP6-10E, CTP10-10E, CTP7-20E  
CTP10-20E, CTP20-10E, CTP20-20E  
CTC6-10E, CTC10-10E, CTC7-20E  
CTC10-20E, CTC20-10E, CTC20-20E

**APPLIED DIRECTIVES** LVD (Low Voltage Directive) 2014/35/EC  
MD (Machinery Directive) 2006/42/EC  
EMC – 2014/30/EC

**APPLIED STANDARDS:** EN 60335-1:2012,  
EN 60335-2-42: 2003 + A1:2008 + A11:2012  
EN 55014-1, EN 55014-2  
EN61000-3-2, EN61000-3-3



*We the undersigned, hereby declare that the equipment specified above conforms to the above Directives and Standards*

Manufacturer Name:  
**ALTO-SHAAM INC.**  
**NAME:** Mrs. Christa Pieper  
**TITLE:** Certification Manager  
**SIGNATURE:** *Christa Pieper*  
**DATE:** *April - 20 - 2016*



DECLARATION OF CONFORMITY

# DECLARATION OF CONFORMITY

**Manufacturer:**

Alto-Shaam, Inc.  
W164 N9221 Water Street  
Menomonee Falls, WI 53202-0450  
U.S.A.



**EQUIPMENT TYPE:** Household and Similar Electric Appliances

**EQUIPMENT DESCRIPTION:** Commercial Steam Convection Ovens

**MODEL NUMBER:** CTP6-10G, CTP10-10G, CTP7-20G  
CTP10-20G, CTP20-10G, CTP20-20G  
CTC6-10G, CTC10-10G, CTC7-20G  
CTC10-20G, CTC20-10G, CTC20-20G

**APPLIED DIRECTIVES** LVD (Low Voltage Directive) 2014/35/EC  
MD (Machinery Directive) 2006/42/EC  
EMC – 2014/30/EC

**APPLIED STANDARDS:** EN 60335-1:2012,  
EN 60335-2-42: 2003 + A1:2008 + A11:2012  
EN 55014-1, EN 55014-2  
EN61000-3-2, EN61000-3-3



*We the undersigned, hereby declare that the equipment specified above conforms to the above Directives and Standards*

Manufacturer Name:  
**ALTO-SHAAM INC.**  
NAME: Mrs. Christa Pieper  
TITLE: Certification Manager  
SIGNATURE: *Christa Pieper*  
DATE: *April - 20 - 2016*



# DECLARATION OF CONFORMITY

**Manufacturer:**  
Alto-Shaam, Inc.  
W164 N9221 Water Street  
Menomonee Falls, WI 53202-0450



**EQUIPMENT TYPE:** Household and Similar Electric Appliances

**EQUIPMENT DESCRIPTION:** Commercial Steam Convection Ovens

**MODEL NUMBER:** CTP6-10E, CTP10-10E, CTP7-20E, CTP10-20E, CTP20-10E, CTP20-20E, CTC6-10E, CTC10-10E, CTC7-20E, CTC10-20E, CTC20-10E, CTC20-20E

**APPLIED UK REGULATIONS:**

- Supply of Machinery (Safety) Regulations 2008
- Electromagnetic Compatibility Regulations 2016
- The Restriction of the Use of Certain Hazardous Substances in Electrical and Electronic Equipment Regulations 2012
- The Ecodesign for Energy-Related Products and Energy Information (Amendment) (EU Exit) Regulations 2019

**APPLIED STANDARDS:**

EN 60335-1:2012  
EN 60335-2-42:2003 + A1:2008 + A11:2012  
EN 55014-1:2018, EN 55014-2:2016



*We the undersigned, hereby declare that the equipment specified above conforms to the above Directives and Standards*

Manufacturer Name:  
**ALTO-SHAAM INC.**  
**NAME:** Christa Pieper  
**TITLE:** Certification Manager

**SIGNATURE:**   
**DATE:** July, 26<sup>st</sup> 2021







# ALTO-SHAAM.

Menomonee Falls, WI U.S.A.

Phone 800-558-8744 | +1-262-251-3800 | [alto-shaam.com](http://alto-shaam.com)

## ASIA

Shanghai, China  
Phone +86-21-6173-0336

## AUSTRALIA

Brisbane, Queensland  
Phone 800-558-8744

## CANADA

Concord, Ontario Canada  
Toll Free Phone 866-577-4484  
Phone +1-905-660-6781

## FRANCE

Aix en Provence, France  
Phone +33(0)4-88-78-21-73

## GMBH

Bochum, Germany  
Phone +49 (0)234 298798-0

## ITALY

Padua, Italy  
Phone +39 3476073504

## INDIA

Pune, India  
Phone +91 9657516999

## MEXICO

Phone +52 1 477-717-3108

## MIDDLE EAST & AFRICA

Dubai, UAE  
Phone +971-4-321-9712

## CENTRAL & SOUTH AMERICA

Miami, FL USA  
Phone +1 954-655-5727