



"WE MAKE THE KITCHEN BETTER!"

ATOSA USA, INC.

Toll Free: 855-855-0399 Email: info@atosausa.com

www.atosa.com | www.atosausa.com

California, Colorado, Florida, Georgia, Illinois,
New Jersey, Ohio, Texas, Washington

Undercounter Refrigerators with Drawers

Standard Features

- Stainless steel exterior & interior with reinforced stainless steel top
- Environmentally friendly R290 refrigerant
- Electronic temperature controller
- Maintains temperatures between 35°F – 38°F
- Recessed door handle(s)
- Magnetic drawer gasket(s)
- Pre-installed casters

Optional Accessories

- Low profile casters available - Part # R06001000228 / R06001000229
- Extended warranty up to 5 years

For the best results of food preservation we recommend setting your refrigerator between 35 °F to 38 °F

1. Don't forget to leave the unit some room to breathe!
2. Please clean the condenser frequently to give the unit more fresh air.



2 YEAR PARTS AND LABOR WARRANTY
5 YEAR COMPRESSOR PART WARRANTY

MODELS:

AUR27D2 / AUR36D2 / AUR48D4 / AUR60D4 / AUR72D6



AUR27D2



AUR36D2



AUR48D4



AUR60D4



AUR72D6





"WE MAKE THE KITCHEN BETTER!"

ATOSA USA, INC.

Toll Free: 855-855-0399 Email: info@atosausa.com

www.atosa.com | www.atosausa.com

California, Colorado, Florida, Georgia, Illinois,
New Jersey, Ohio, Texas, Washington

SPECIFICATIONS

Models	Drawers	Capacity (Cu.Ft.)	Casters (inch)	Rated Current (A)	Voltage (V/Hz/Ph)	HP	Refrigerant	Exterior Dimensions (inch)	Net Weight (lb)	Gross Weight (lb)
AUR27D2	2	6.5	2	3.4	115/60/1	1/6	R290	27 ^{1/2} ×30×32 ^{1/2}	178	233
AUR36D2	2	9	2	3.4	115/60/1	1/6	R290	36 ^{3/8} ×30×32 ^{1/2}	207	271
AUR48D4	4	12.2	2	3.4	115/60/1	1/6	R290	48 ^{1/4} ×30×32 ^{1/2}	271	348
AUR60D4	4	15.5	2	3.9	115/60/1	1/5+	R290	60 ^{1/4} ×30×32 ^{1/2}	319	394
AUR72D6	6	18.9	2	3.9	115/60/1	1/5+	R290	72 ^{5/8} ×30×32 ^{1/2}	334	433

PLAN VIEW

AUR27D2

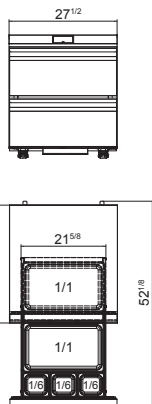

AUR36D2

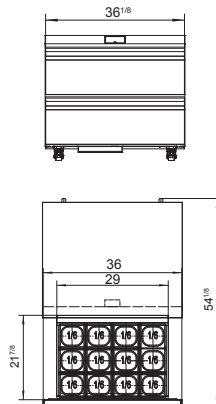

AUR48D4

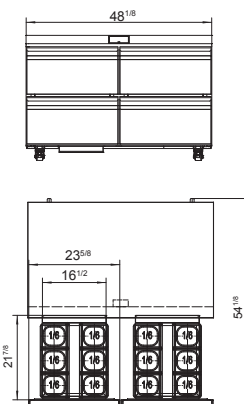

AUR60D4

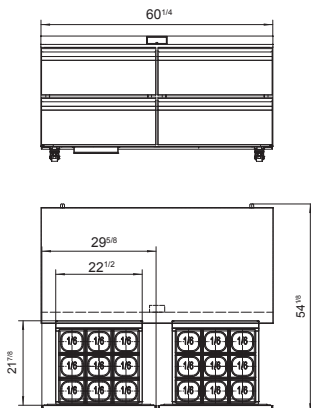

AUR72D6

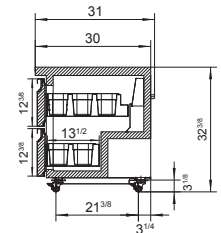
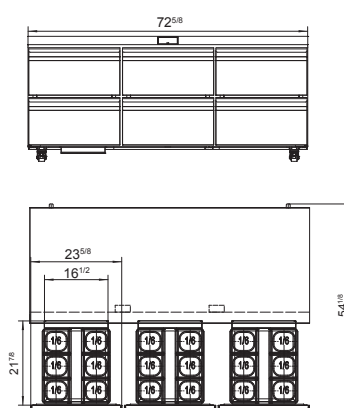

Interior Dimensions

Interior Dimensions

Casters



Rear grate



Temperature control



NEMA 5-15P

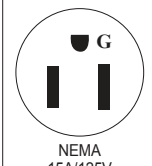

NEMA
15A/125V



"WE MAKE THE KITCHEN BETTER!"

ATOSA USA, INC.

Toll Free: 855-855-0399 Email: info@atosausa.com

www.atosa.com | www.atosausa.com

California, Colorado, Florida, Georgia, Illinois,

New Jersey, Ohio, Texas, Washington

PAN CONFIGURATION

AUR27

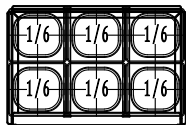
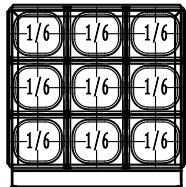
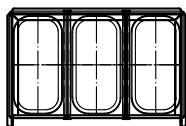
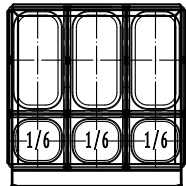
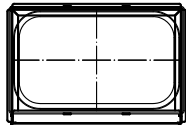
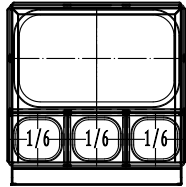

AUR36

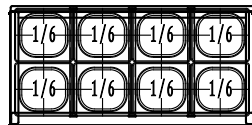
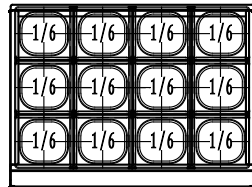
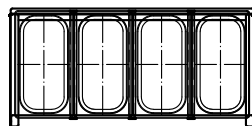
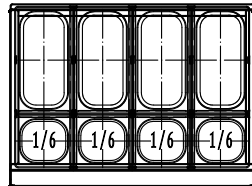
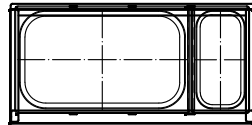
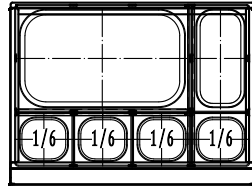

AUR48

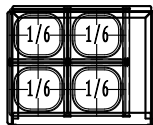
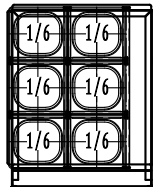
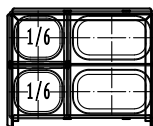
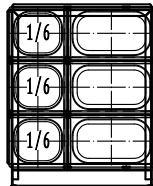
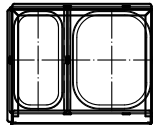
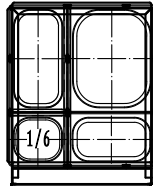

AUR60

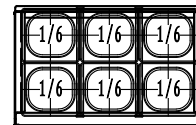
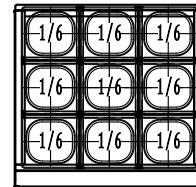
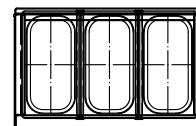
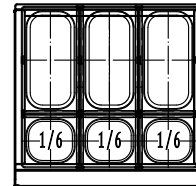
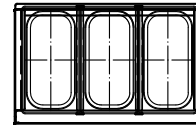
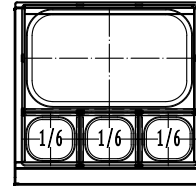

AUR72

