

**PLAN VIEW**  
RIGHT HINGE  
SELECT

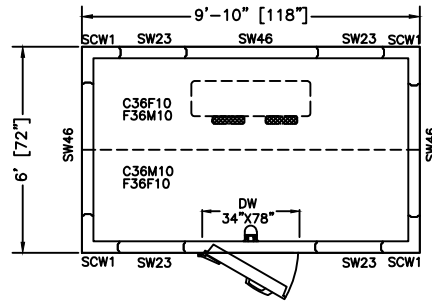

**PLAN VIEW**  
LEFT HINGE  
SELECT

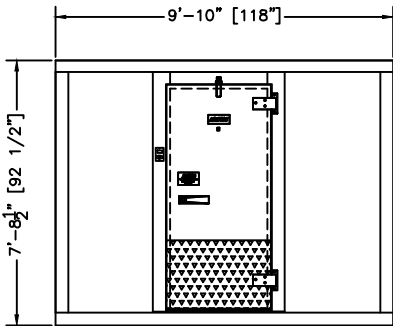

**ELEVATION**  
RIGHT HINGE

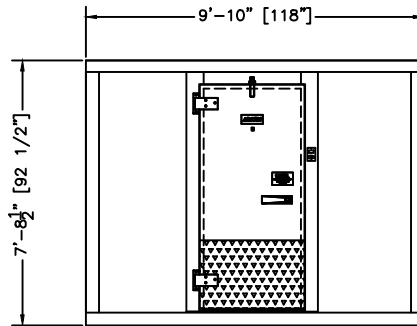

**ELEVATION**  
LEFT HINGE

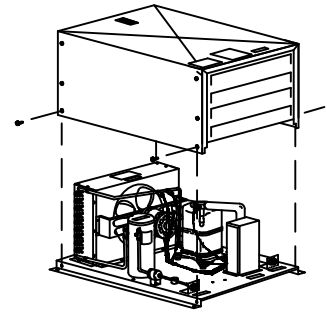

**CONDENSING UNIT  
DETAIL**

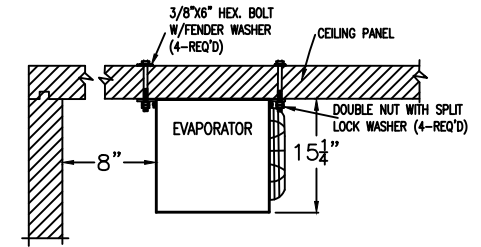

**EVAPORATOR MOUNTING DETAIL  
(MOUNTING HARDWARE  
BY OTHERS)**

PRODUCT SPECIFICATIONS	
MODEL:	BL106-CF-R
WALK-IN SPECIFICATION	
INTERIOR/EXTERIOR FINISH	26 GAUGE MILL EMBOSSED ACRYLUME OR 26 GAUGE STUCCO EMBOSSED GALVANIZED STEEL
ELECTRICAL (VOLTS/Hz/PH)	115/60/1
MAX AMP.	0.8
EVAPORATOR SPECIFICATION	
ELECTRICAL (VOLTS/Hz/PH)	115/60/1
AMPS	20
WEIGHT (LBS)	44
CONDENSOR SPECIFICATION	
ELECTRICAL (VOLTS/Hz/PH)	208-230/60/1
AMPS	15
WEIGHT (LBS)	152
WALK-IN AND REFRIGERATION FREIGHT	
TOTAL SHIPPING WEIGHT (LBS)	1180
MAXIMUM PALLET SIZE	48" X 120" X 102" HIGH
NUMBERS OF PALLETS	2

MODEL: BL106-CF-R

INDOOR-WITH FLOOR

COOLER 35°F

REMOTE PRE-ASSEMBLED REFRIGERATION

CUSTOMER APPROVAL

DATE: \_\_\_\_\_

SIGNATURE: \_\_\_\_\_

**CONFIDENTIAL**

THE DRAWINGS, TECHNICAL DATA, AND ALL OTHER INFORMATION SET FORTH IN THIS DOCUMENT COMPRISE TRADE SECRETS AND CONFIDENTIAL INFORMATION THAT IS THE EXCLUSIVE PROPERTY OF ARCTIC INDUSTRIES, LLC.

USE OF SUCH INFORMATION IS LIMITED TO THE PURPOSE FOR WHICH IT WAS PROVIDED AND NO RECIPIENT IS PERMITTED TO USE, COPY, OR DISCLOSE SUCH INFORMATION EXCEPT AS EXPRESSLY AUTHORIZED BY ARCTIC INDUSTRIES, LLC.

**Arctic**<sup>®</sup>  
WALK-IN COOLERS AND FREEZERS  
MIAMI, FLORIDA  
Phone: (305) 883-5581  
LOS ANGELES, CALIFORNIA  
Phone: (626) 508-0920

**ETL** US  
Intertek  
CONFORMS TO  
UL STD 471

**ETL**  
Intertek  
CONFORMS TO  
NSF STD 7

**EISA**