

Camtherm® Bulk Food Cabinets, Hot / Cold

Low Profile, Single Door & Cavity

External Fahrenheit Thermometer

Model CMBHC1826LF

External Centigrade Thermometer

Model CMBHC1826LC

Item No. _____

Specifier Identification No. _____

Model No. _____

Quantity _____

Features & Benefits



- Unique and versatile plastic-based thermoelectric cart is designed for holding and transporting food on or off-premise. Food remains at safe serving temperatures. Holds hot or cold food temperatures without electrical source for hours.
- Thermoelectric unit located on back of unit is completely enclosed in a protective, powder coated, steel encasement. When the power is on, it will maintain the air temperature inside the cavity at an even range of 150°F (65°C) to 165°F (74°C) or 37°F (2,8°C) in accordance with HACCP guidelines. When heated to 165°F (74°C) and then turned off for passive holding or transporting, the temperature inside the cavity stays above 140°F (60°C) for 8 hours when the cabinet is full. When cooled to 37°F (2,7°C) and then turned off, the internal cavity temperature will remain below 41°F (5°C) for 2 hour when cabinet is full. Electrical cord length is 10' (305 cm) and there is a wrapping hook for easy storage.
- Easy-to-use control panel includes a virtually unbreakable, polycarbonate waterproof cover, on-off power switch, temperature setting dial, auto green light for "power on" indicator and auto red light for "set temperature achieved."
- Internal thermometer has a solar powered external digital display available in either Fahrenheit or Centigrade so cavity temperatures can be checked at a glance.
- Double wall, polyethylene external construction is impact resistant and will not dent, crack, bubble, chip or break. Thick, polyurethane foam insulation helps to ensure excellent food temperature retention during holding and transporting.
- Includes anodized aluminum uprights and six sets of easy to remove chrome plated steel slide rails for full size food pans and/or 18" x 26" (45,7 x 66 cm) sheet pans.
 - GN 1/1 Full Size Food Pan capacity:
 - 12 each 2 1/2" (6,5 cm) deep
 - 8 each 4" (10 cm) deep
 - 6 each 6" (15 cm) deep
 - 4 each 8" (20 cm) deep
 - Sheet Pan capacity:
 - 11 each (requires 5 additional sets of slide rails)
- Marine rail on top holds two each full size food pans, on 18" x 26" (45,7 x 66 cm) sheet pan or a cutting board to stage service.
- Inside cavity floor design allows water condensation or spills to be collected at the bottom without leaking out of the unit. Can be easily wiped down.
- Aluminum louvers located in the back wall of the cavity direct air flow for even distribution and are easy to remove and clean.
- Vent cap allows steam to be released and keeps menu items from becoming soggy.
- Durable nylon door latch is easy to open and closes securely to provide maximum temperature retention. Magnetic seal gasket provides a tight seal for enhanced hot or cold temperature retention while still permitting easy opening and closing of the door.
- Doors swing open 270° to provide easy access to contents and keeps the door out of the way when removing or inserting food pans or sheet pans. Knuckle hinge mechanism makes them extra sturdy and easy to remove for cleaning.
- Ergonomic, molded-in steering handles provide comfortable, easy transporting.
- Four each non-marking high modulus rubber casters provide easy transporting and maneuvering. Includes two each 6" (15,2 cm), front swivel with brake and nickel plated hub and two each 10" (25,4 cm) rear rigid with aluminum hub.
- Minimal assembly required.
- Available in 3 colors.



Front View



Rear View

Approvals



Camtherm® Bulk Food Cabinets, Hot / Cold

Low Profile, Single Door & Cavity

External Fahrenheit Thermometer

Model CMBHC1826LF

External Centigrade Thermometer

Model CMBHC1826LC

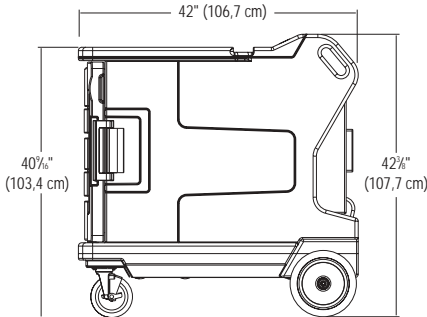

Side View

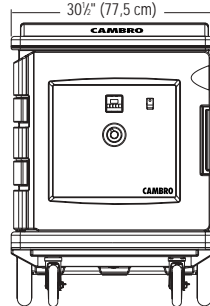

Front View

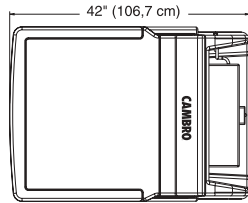

Top View

ELECTRICAL	110V
Maximum amp draw	9.1
Amps run on	8.5
Watts	1100
Hertz	50/60
Power input (ground fault protected)	120 VAC

Specifications

Code	Thermometer	External Dimensions W x D x H	Internal Dimensions W x D x H	Unit Weight Lbs. (Kg)	Case Lbs. (cube)	Case kg (m ³)
CMBHC1826TLF	Fahrenheit	30 1/2" x 42" x 42 1/8" (77,5 x 106,7 x 107,6 cm)	22 1/2" x 23 1/8" x 26 3/4" (57,2 x 58,7 x 68 cm)	222 (100,7)	237 (32.85)	107,5 (0,93)
CMBHC1826TLC	Celsius	30 1/2" x 39" x 64 1/4" (77,5 x 106,7 x 107,6 cm)	22 1/2" x 23 1/8" x 26 1/4" (57,2 x 58,7 x 68 cm)	222 (100,7)	237 (32.85)	107,5 (0,93)

Colors: Granite Gray (191), Granite Green (192), Granite Sand (194).

Caster Configuration:

2 each 6" (15,2cm) front swivel w/brake, 2 rear 10" (25,4cm) Big Wheels

Code	Description	External Dimensions W x D	Case Lbs. (cube)	Case kg (m ³)
CB1220	Cutting Board	21" x 13 1/8" x 1/2" (53,3 x 33,5 x 1,3 cm)	5.5 (.15)	2,5 (0,004)
CMBR	Slide Rail Set	20" x 4 13/16" (50,8 x 12,2 cm)	2.25 (.11)	1,02 (0,003)

Camwear® Clear Polycarbonate and/or H-Pan® High Heat Food Pans are recommended for use with Camtherm Cabinets.

Architect Specs

The Low Profile Camtherm Bulk Food Holding Cabinet, Hot/Cold, shall be Cambro Model... manufactured by Cambro Manufacturing Company, Huntington Beach, CA 92647. Each cabinet shall be made of a polyethylene shell filled with foamed-in-place polyurethane and heated via a thermoelectric unit enclosed in a powder-coated steel encasement on the back of the unit. It shall have a nylon latch, magnetic gaskets, self-ventilating caps and knuckle door

Item No. _____

Specifier Identification No. _____

Model No. _____

Quantity _____

HOT HOLDING

TIME	150°F (65°C)	165°F (74°C)
WARM UP TIME	33 minutes	45 minutes
(from ambient to temperature)		
RECOVERY TIME*	2 minute	4 minutes
(time to recover to temperature after door is held open for 30 seconds)		
TRANSPORT TIME*	5 hours	8 hours
(after reaching temperature, amount of time unit can be held passively/unplugged until temperature reaches 140°F (60°C).		

* Based on test with 6 each full size 6" (15,2cm) deep H-Pans™ filled with 190°F (87,7°C) hot water.

COLD HOLDING

TIME	37°F (2,7°C)
COOLING TIME (empty)	50 minutes
(from ambient to temperature)	
RECOVERY TIME*	4 minutes
(time to recover to temperature after door is held open for 30 seconds)	
TRANSPORT TIME*	2 hours
(after reaching temperature, amount of time unit can be held passively/unplugged until temperature reaches 41°F (5°C).	

* Based on test with 6 each full size 6" (15,2cm) deep Camwear® Pans filled with 34°F (1,1°C) cold water.

HOLDING CAPACITY (Includes 6 Rail Sets)

SIZE	QUANTITY
18" x 26" (45,7 x 66 cm) Sheet Pan	11*
12" x 20" (32,5 x 53 cm) Full Size Food Pan 2 1/2" (6,5 cm) Deep	12
12" x 20" (32,5 x 53 cm) Full Size Food Pan 4" (10 cm) Deep	8
12" x 20" (32,5 x 53 cm) Full Size Food Pan 6" (15 cm) Deep	6
12" x 20" (32,5 x 53 cm) Full Size Food Pan 8" (20 cm) Deep	4

*Requires five additional rail sets.

Dimension Tolerance: +/- 1/4" (0,64 cm)

Approvals



© 2004 Cambro Manufacturing Company 5801 Skylab, Huntington Beach, California 92647-2056-U.S.A.
Telephone (1)714 848 1555 Toll Free 800 854 7631 Customer Service Hot Line 800 833 3003

Printed in USA