



STAINLESS STEEL Liquor Display Cabinet 21" Wide Units

Item #: _____ Qty #: _____

Model #: _____

Project #: _____



**CRLR-24
Shown**



**Optional Locking Cover
Available - Includes
Padlock & 2 Keys**

FEATURES:

- Five tiered steps to display liquor bottles.
- Steel straps secure bottles on steps.
- 4" backsplash.
- Stainless steel legs with adjustable plastic bullet feet.
- Optional stainless steel cover includes padlock and two keys.

MATERIAL:

- Interior & Sides:** 20 gauge, 300 stainless steel
- Straps:** 18 gauge, 300 stainless steel
- Backsplash:** 22 gauge, 300 stainless steel
- Legs:** 1 5/8" O.D. 16 gauge stainless steel with 1" adjustable plastic bullet feet

OPTIONAL:

- All Optional Stainless Steel Covers Include Padlock & Two Keys
- LC-12** - 12" stainless steel cover
- LC-18** - 18" stainless steel cover
- LC-24** - 24" stainless steel cover
- LC-30** - 30" stainless steel cover
- LC-36** - 36" stainless steel cover

21" WIDE Model #	Overall Length (A)	Approx. Bottle Capacity	Approx. Weight	Approx. Cu. Ft.
CRLR-12	12"	15	35 lbs.	7
CRLR-18	18"	20	36 lbs.	10
CRLR-24	24"	30	42 lbs.	13
CRLR-30	30"	35	47 lbs.	14
CRLR-36	36"	45	50 lbs.	15

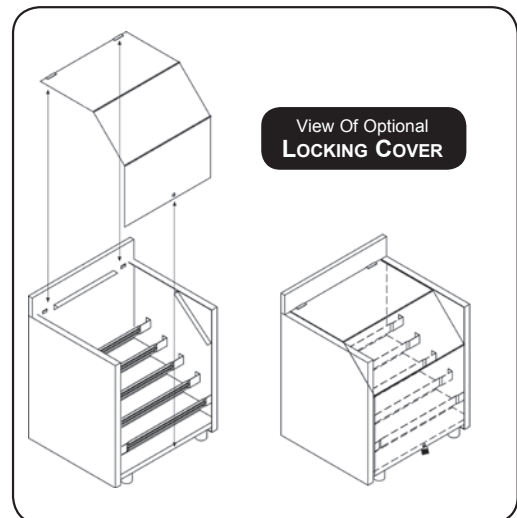

Customer Service Available To Assist You 1-800-645-3166 8:30 am - 8:00 pm E.S.T.

For Orders & Customer Service:
Email: customer@advancetabco.com or Fax: 631-242-6900

For Smart Fabrication™ Quotes:
Email: smartfab@advancetabco.com or Fax: 631-586-2933

DIMENSIONS and SPECIFICATIONS

TOL Overall: $\pm .500''$ Interior: $\pm .250''$

ALL DIMENSIONS ARE TYPICAL

