



Deep Drawn Drop-In Sink with 3-Sided Riser

Drop In Sinks

Certifications:



Features:

- Deep Drawn Construction for a seamless and more appealing design
- Traditional Top Mount
- Includes BKDR-4 Drain
- Faucet Holes 4" O.C.

Material:

- T-304 20 ga. Stainless Steel



Options:

- Upgrade to OptiFlow Heavy Duty Faucets or Evolution Stainless Steel Faucets
- Wrist Blades
- "-P-G" Includes BKD-5G-G Lead-Free Faucet

Part Number	Unit Size (l x w x d)	Bowl Size (l x w x d)	Included Faucet
DDI-1014524S	12 ⁵ / ₈ " x 18 ¹ / ₂ " x 10 ¹ / ₂ " (d)	10" x 14" x 5" (d)	-
DDI-1014524S-P-G	12 ⁵ / ₈ " x 18 ¹ / ₂ " x 10 ¹ / ₂ " (d)	10" x 14" x 5" (d)	BKD-5G-G

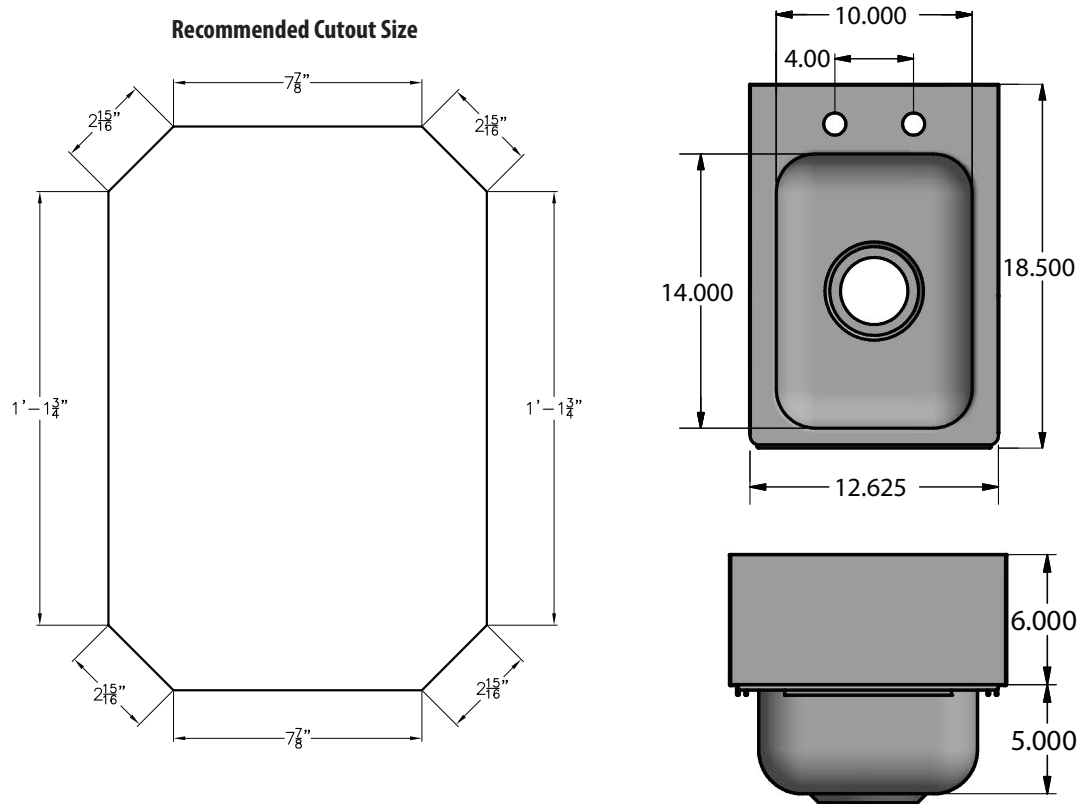

PRODUCT DATA SHEET

BK RESOURCES

