



Deep Drawn 2 Compartment Drop-In Sink

Drop In Sinks

Certifications:



Features:

- Deep Drawn Construction for a seamless and more appealing design
- Traditional Top Mount
- Includes (2) BKDR-4 Drains
- Faucet Holes 4" O.C.

Material:

- T-304 20 ga. Stainless Steel

Options:

- Upgrade to OptiFlow Heavy Duty Faucets or Evolution Stainless Steel Faucets
- Wrist Blades
- "-P-G" Includes BKD-8G-G Lead-Free Faucet

Part Number	Unit Size (l x w x d)	Bowl Size (l x w x d)	Included Faucet
DDI2-10141024	24" x 18 1/2" x 10" (d)	10" x 14" x 10" (d)	-
DDI2-10141024-P-G	24" x 18 1/2" x 10" (d)	10" x 14" x 10" (d)	BKD-8G-G

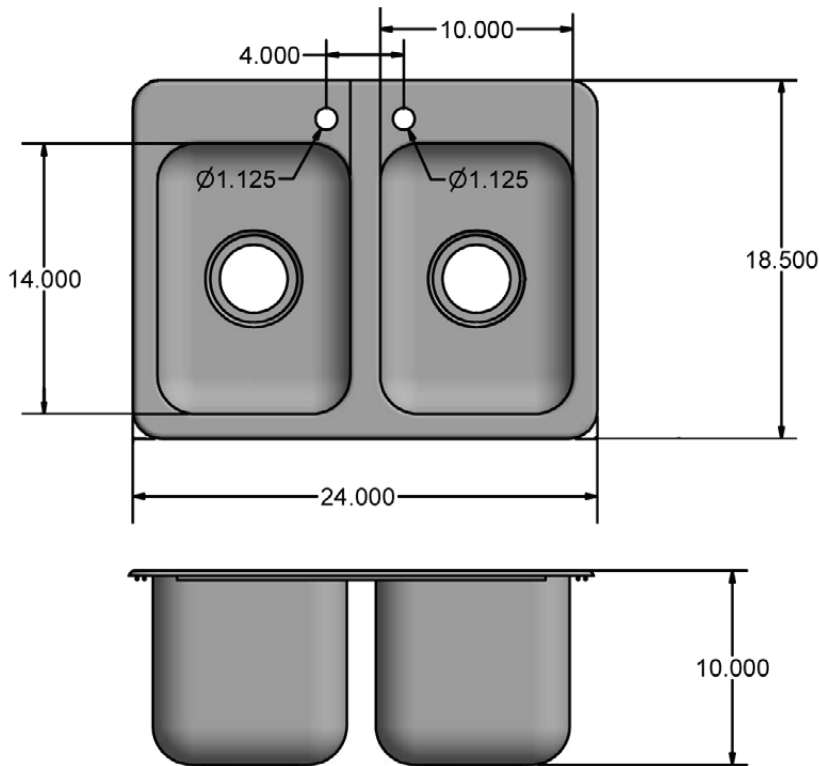

PRODUCT DATA SHEET

BK RESOURCES



Deep Drawn 2 Compartment Drop-In Sink

Drop In Sinks

Recommended Cutout Size

