



PROJECT	
ITEM #	
QUANTITY	DATE
APPROVAL	

SCU & SCU-NU Mobile Beverage Counters

Short Form Specifications

Exterior body is constructed of 18-gauge stainless steel side panels and 14-gauge galvanized bottom. All exterior side panels are reinforced with overlapping corners and are welded in place. All body cutouts are reinforced with 14-gauge galvanized channel supports.

Exterior top is constructed of 14-gauge stainless steel, welded, ground and polished into one integral unit. Top is fabricated with square exterior corners. Top is reinforced and includes a stainless steel drain trough with a removable stainless steel anti-splash drip gate. Drain trough has a 1" (2.5cm) I.P.S. drain plumbed to a drain valve located at the right bottom of the unit. Drain trough is located on the customer's side of counter top.

Casters unit is mounted on 5" (12.7cm) diameter swivel casters with non-marking polyolefin tires and plate brakes. Overall height of caster assembly is 6" (15.2cm).

The following applies to SCU Series only

SCU units have a two door dry compartment(s) constructed of 18-gauge stainless steel. Each compartment is equipped with a stainless steel shelf) are double-wall construction, with stainless steel front panel.

- SCU-36, one compartment, 24" wide with one door
- SCU-50, one compartment, 36" wide with two doors
- SCU-60, one compartment, 48" wide with two doors
- SCU-74, one compartment, 48" wide with two doors,
- SCU-96, two compartments, each 36" wide with two doors each

Optional Accessories and Modifications

- A) 12" (30.5cm) wide stainless steel fold-down tray slide
- C) 10" (25.4cm) wide three-bar fold-down tray slide
- D) 10" (25.4cm) wide composite fold-down cutting boards
- E) 10" (25.4cm) wide stainless steel fold-down work shelf
- F) Line-up interlock device
- FF) Dual service drain troughs
- LD) Laminate door panel insert (SCU Series only)
- P) Open understorage with shelf (SCU-NU Series only)
- Q) *120V/60Hz/1Ø, 10 amp convenience outlet with breaker
- SG5A) Single dry insert with doors (SCU-NU Series only)
- SG5B) Double dry insert with doors (SCU-NU Series only)
- ST) Stainless steel trim strips
- U) 14" x 30" (35.6cm x 76.2cm) stainless steel end drop shelf
- V) 6" (15.2cm) high adjustable stainless steel legs in lieu of casters
- X) Laminate exterior panels in lieu of stainless steel exterior panels

*Inclusion of this options will alter the electrical specifications of unit.



Model SCU-50-NU
shown with option legs



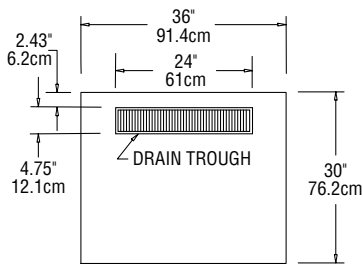

**PLAN VIEW
SCU-36/
SCU-35-NU**

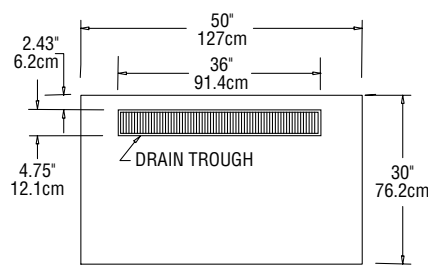

**PLAN VIEW
SCU-50/
SCU-50-NU**

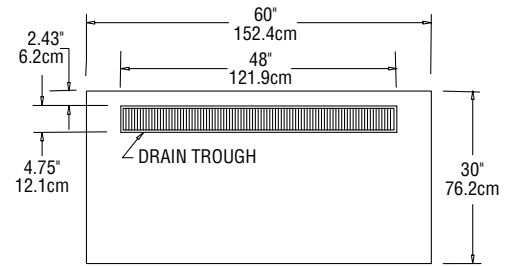

**PLAN VIEW
SCU-60/
SCU-60-NU**

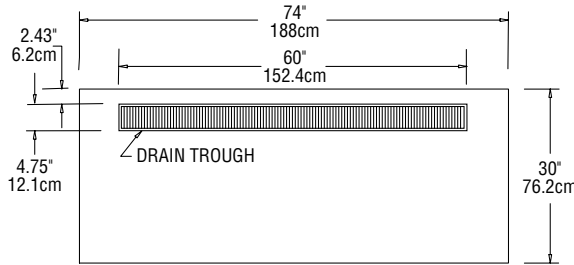

**PLAN VIEW
SCU-74/
SCU-74-NU**

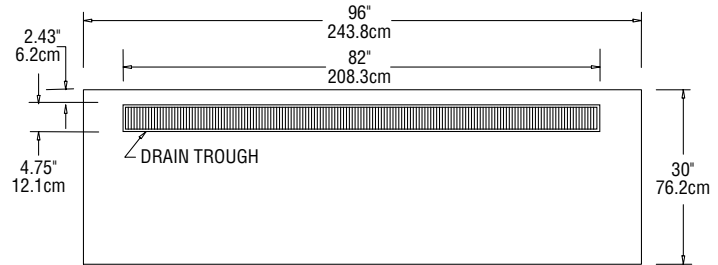

**PLAN VIEW
SCU-96/
SCU-96-NU**

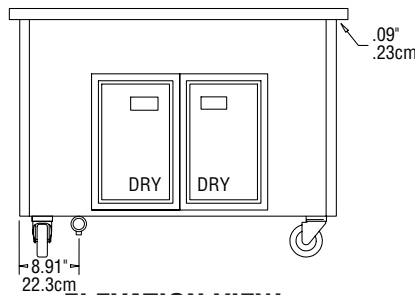

**ELEVATION VIEW
SCU-50 THROUGH SCU-96
(SCU-96 two compartment
not shown)**

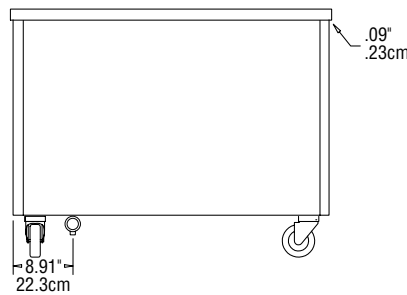

**ELEVATION VIEW
ALL SCU-NU MODELS**

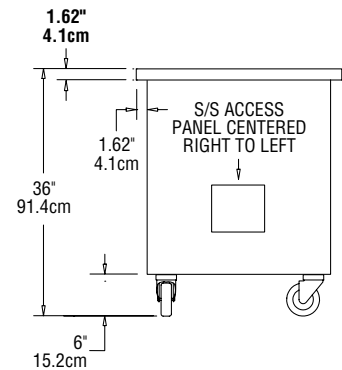

**END VIEW
ALL MODELS**

Mechanical Data—Standard Unit

MODEL NUMBER	# OF DOORS	# OF SHELVES	SHIP WEIGHT	MODEL NUMBER	SHIP WEIGHT
SCU-36	1	1	200 lbs/91 kg	SCU-36-NU	170 lbs/77 kg
SCU-50	2	1	230 lbs/104 kg	SCU-50-NU	190 lbs/86 kg
SCU-60	2	1	270 lbs/123 kg	SCU-60-NU	230 lbs/104 kg
SCU-74	2	1	300 lbs/136 kg	SCU-74-NU	260 lbs/118 kg
SCU-96	4	2	340 lbs/154 kg	SCU-96-NU	300 lbs/136 kg