



# UC4460N Salad Top

Reduced Height Front-Breathing Self-Contained Salad Top Refrigerated Bases

Project \_\_\_\_\_

Item \_\_\_\_\_

Quantity \_\_\_\_\_

CSI Section 11400

Approved \_\_\_\_\_

Date \_\_\_\_\_

## Models

- UC4460N-8 Two section with doors, eight pan capacity
- UCD4460N-8 Two section with drawers, eight pan capacity
- UC4460N-12 Two section with doors, twelve pan capacity
- UCD4460N-12 Two section with drawers, twelve pan capacity

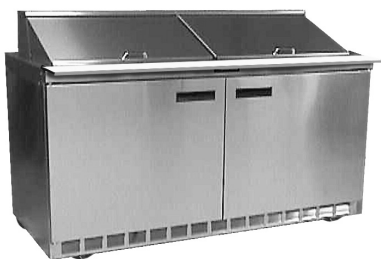

UC4460N-12

## Standard Features

- Patented air screen ensures product stays cold without drying it out
- All 4400 Series units are 100% front breathing, which allows the unit to be pushed against a wall or built into a cabinet or an existing line up
- Durable, rugged stainless steel sides, top and front
- Features Delfield's exclusive ABS interior (on sides). ABS is extremely durable - it won't dent, chip or corrode and is backed by a limited lifetime warranty
- Delfield supplies 1/6 size pans and positive placement adapter bars for top opening
- Dual level pan brackets allow the pans to be lowered an additional inch in the unit without tools to provide additional pan temperature holding performance
- Salad top refrigerators are standard with 10" wide,

dishwasher safe polyethylene cutting board treated with antimicrobial agent

- "D" prefix models feature Delfield's new drawer system. Drawers are backed by a 10-year warranty on the track assembly
- Environmentally friendly R404A refrigerant
- High density foamed in place environmentally friendly, Kyoto Protocol Compliant, Non ODP (Ozone Depletion Potential), Non GWP (Global Warming Potential) polyurethane keeps energy costs low
- Black recessed quick grip handle
- Standard on 3" casters for easy cleaning and installation
- 6' cord and plug supplied
- One epoxy coated wire shelf standard, installed per door section
- ACT solid state electronic control
- Three year parts and labor warranty and an additional two year compressor parts warranty

## Options & Accessories

- Flat lift off cover
- 18" wide single tier overshef
- Stainless steel finish on back
- Plastic laminate on front
- Additional wire shelves
- Door lock
- Exterior thermometer
- 220V/50 Hertz electrical system\*

\* Inclusion of this option will alter electrical specifications of the unit



## UC4460N-8

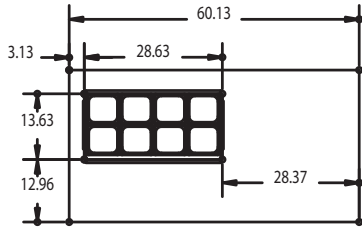

UC4460N-8 Pan Cutout Configuration

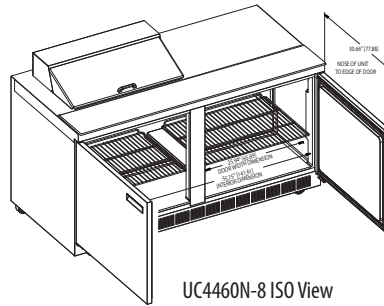

UC4460N-8 ISO View

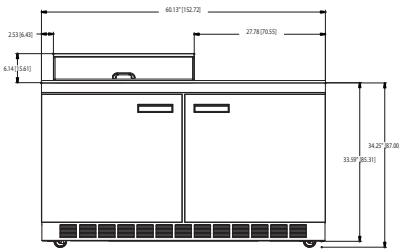

UC4460N-8 Elevation View

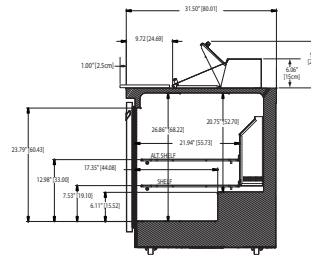

UC4460N-8 Right Side View

## UCD4460N-8

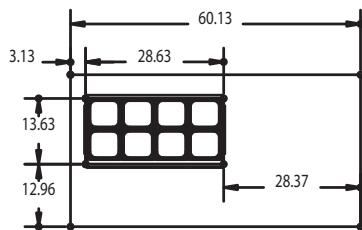

UCD4460N-8 Pan Cutout Configuration

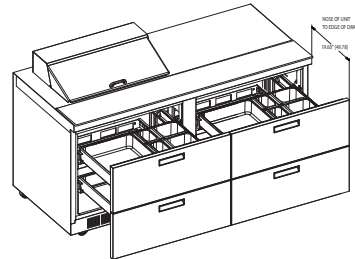

UCD4460N-8 ISO View

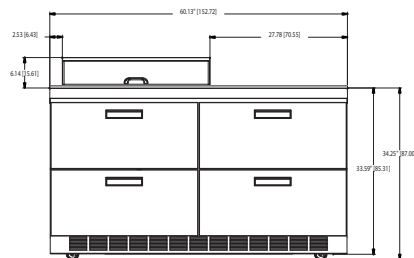

UCD4460N-8 Elevation View

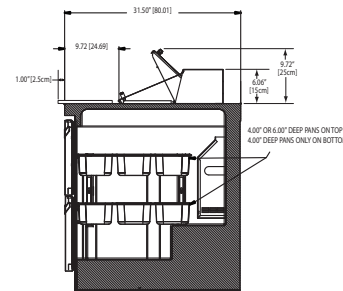

UCD4460N-8 Right Side View

## UC4460N-12

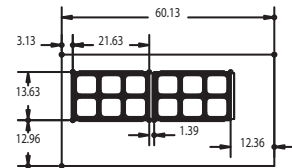

UC4460N-12 Pan Cutout Configuration

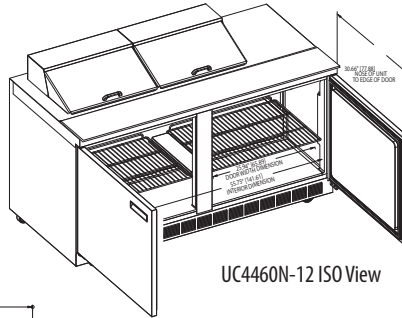

UC4460N-12 ISO View

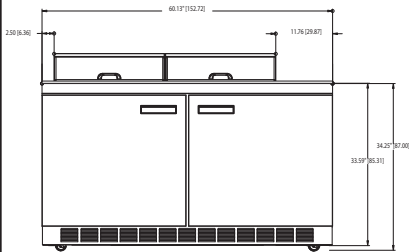

UC4460N-12 Elevation View

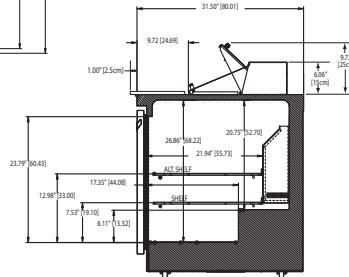

UC4460N-12 Right Side View

## UCD4460N-12

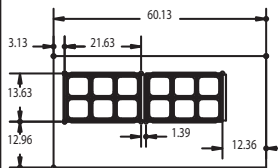

UCD4460N-12 Pan Cutout Configuration

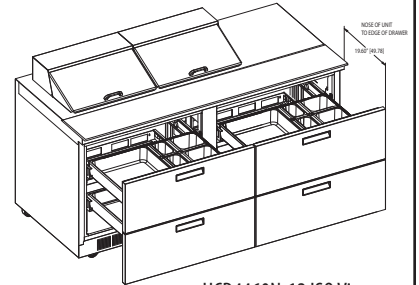

UCD4460N-12 ISO View

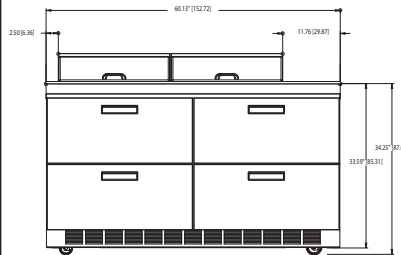

UCD4460N-12 Elevation View

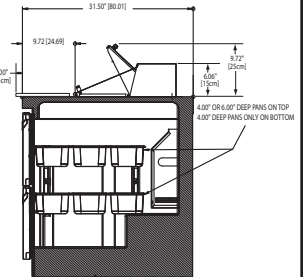

UCD4460N-12 Right Side View

## UC4460N Salad Top

### Specifications

Model	1/6 Size Pan Cap.	# of Shelves	Shelf Area	Volume	H.P.	V/Hz/Ph	Amps	Nema Plug	Ship Weight
UC4460N-8	8	2	7.19ft <sup>2</sup>	20.20ft <sup>3</sup>	1/2	115/60/1	12.0	5-15P	411lbs/186kg
UCD4460N-8	8	NA	NA	20.20ft <sup>3</sup>	1/2	115/60/1	12.0	5-15P	495lbs/225kg
UC4460N-12	12	2	7.19ft <sup>2</sup>	20.20ft <sup>3</sup>	1/2	115/60/1	12.0	5-15P	411lbs/186kg
UCD4460N-12	12	NA	NA	20.20ft <sup>3</sup>	1/2	115/60/1	12.0	5-15P	495lbs/225kg

Delfield reserves the right to make changes to the design or specifications without prior notice.

### INSTALLATION NOTE:

Refrigeration system is designed so that air will flow under the unit, through the compressor area and out the front of the unit. Any restriction to this air flow path will void the warranties.



# UC4460N Salad Top

Reduced Height Front-Breathing Self-Contained Salad Top Refrigerated Bases

## Specifications

**Exterior top** is one-piece 22-gauge stainless steel with integral 2.12" (5.4cm) square nosing at the front. Top of drawer unit has openings to accept 8 or 12 1/6-size 4" (10cm) deep plastic pans. Top of door unit has openings to accept 8 or 12 1/6-size 4" or 6" (10cm or 15cm) deep plastic pans. Adapter bars and 1/6 pans are supplied by Delfield. Temperature in top opening to maintain 33°F (1°C) to 41°F (5°C), with pans recessed 2.5" (6.4cm) at 86°F ambient room temperature, meeting NSF 7 requirements. One 60" x 10" x .5" (152cm x 25.4cm x 1.3cm) polyethylene cutting board treated with antimicrobial agent is mounted on the top at the front edge.

**Dual level pan brackets** allow the pans to be lowered an additional inch in the unit without tools to provide additional pan temperature holding performance.

**Exterior back and bottom** are two-piece 24-gauge galvanized steel. Exterior ends are stainless steel.

**Interior sides** are thermoformed ABS plastic with shelf supports. Base is fully insulated with high-density foamed in place environmentally friendly, Kyoto Protocol Compliant, Non ODP (Ozone Depletion Potential), Non GWP (Global Warming Potential) polyurethane.

**Refrigeration** system uses HFC-404A refrigerant. Compressor is 1/2 H.P., with condenser coil and condensate evaporator mounted on rear of the cabinet. Evaporator coil is located on the interior rear wall of the cabinet. Refrigerant flow is controlled by a capillary tube. Cabinet maintains an interior cabinet temperature of 36°F to 40°F (2°C to 4°C).

**ACT control:** ACT electronic, solid state control, mounted on the exterior rear of the cabinet, allows unit to maintain precise temperatures in heavy duty conditions.

**Electrical** connections are 115 volt, 60 Hertz, single phase. Unit has a 6' (1.8m) long electrical cord and NEMA 5-15P plug.

**Casters:** Equipment is mounted on 3" (7.6cm) diameter plate casters. Equipment clearance above the floor is 0.66" (1.7cm).

**Doors** have a 24-gauge stainless steel exterior, with thermoformed ABS plastic interior liner. Cabinet has one adjustable epoxy-coated wire shelf per door opening.

**Drawer** fronts have a 24-gauge stainless steel exterior, with thermoformed ABS plastic interior liner. Drawer frames are 12-gauge stainless steel. Drawer slides are 11-gauge stainless steel with Delrin bearings. Each section has two drawers. Each top drawer holds one full size 12" x 20" (30.5cm x 50.8cm) pan, three 1/6 size and three 1/9 size 4"-6" (10.2cm -15.2cm) deep pans. Each bottom drawer holds one 12" x 20" (30.5cm x 50.8cm) pan, three 1/6 size and three 1/9 size 4" (10.2cm) deep pans. Pans supplied by others.

