



**John  
BOOS**  
Since 1887

ITEM #: \_\_\_\_\_ QTY: \_\_\_\_\_

MODEL #: \_\_\_\_\_

PROJECT NAME: \_\_\_\_\_

3601 S. Banker St. Effingham, IL 62401 • P.O. BOX 609 • Ph: (888) 431-2667 • Fax: (800) 433-2667

## SLIM-LINE UNDERBAR SINKS

### FEATURES:

- FABRICATED BOWLS: 10" X 14" X 10"
- STAMPED RIBBED DRAIN BOARDS
- RAISED MARINE EDGE ON FRONT & SIDES
- GALVANIZED LEGS AND BRACING, WITH ADJUSTABLE BULLET FEET

### CONSTRUCTION:

- TOP: STAINLESS STEEL TOPS ARE TIG WELDED, EXPOSED WELDS ARE POLISHED TO MATCH ADJACENT SURFACE.

### MATERIAL:

- TOP: 18GA 300 SERIES STAINLESS STEEL
- BRACING: GALVANIZED
- LEGS: GALVANIZED
- GUSSETS: GALVANIZED
- FEET: PLASTIC

### INCLUDES:

- ECONOMY FAUCET (PBF-4-D-10LF)
- OVERFLOW PIPES (PB-OVF-BS)



### **SLIM-LINE UNDERBAR SINKS**

MODEL #	QTY
EUB2S36SL-1RD	
EUB2S36SL-1LD	
EUB2S48SL-1RD	
EUB2S48SL-1LD	
EUB2S48SL-2D	
EUB3S40SL	
EUB3S48SL-1RD	
EUB3S48SL-1LD	
EUB3S60SL-1RD	
EUB3S60SL-1LD	
EUB3S60SL-2D	
EUB3S72SL-2D	
EUB3S84SL-2D	
EUB3S96SL-2D	
EUB4S72SL-2D	
EUB4S84SL-2D	
EUB4S96SL-2D	



EUB3S72SL-2D  
SHOWN WITH FAUCET  
MODEL #: PBF-4-D-10LF

### **OPTIONAL ACCESSORIES**

MODEL #	QTY
SPEED RAILS	
STAINLESS STEEL LEGS	

# SLIM-LINE UNDERBAR SINKS DETAILED SPECIFICATIONS

EUB4S72SL-2D  
EUB4S84SL-2D  
EUB4S96SL-2D

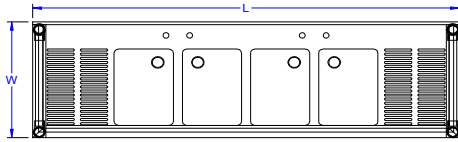

EUB2S48SL-1RD  
EUB2S48SL-1LD

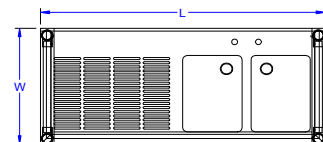

EUB3S60SL-2D  
EUB3S72SL-2D  
EUB3S84SL-2D  
EUB3S96SL-2D

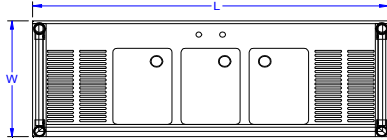

EUB2S48SL-2RD

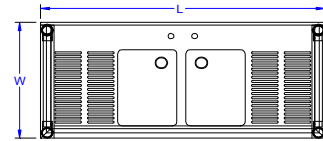

EUB3S48SL-1RD  
EUB3S48SL-1LD  
EUB3S60SL-1RD  
EUB3S60SL-1LD

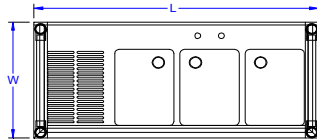

EUB2S36SL-1RD  
EUB2S36SL-1LD

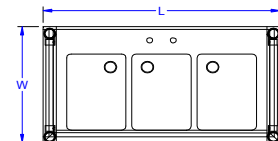
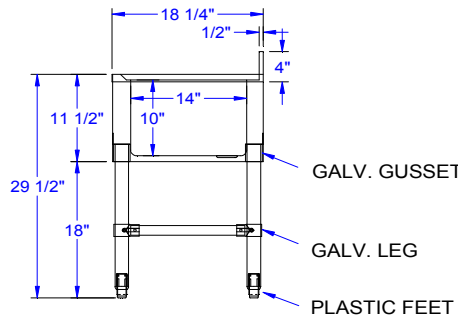
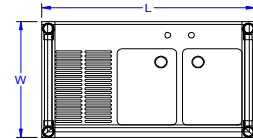

EUB3S40SL



## SLIM-LINE UNDERBAR DRAIN BOARDS

RD = RIGHT DRAIN BOARD  
LD = LEFT DRAIN BOARD

MODEL #	LENGTH	WIDTH	DB	HEIGHT	WT. (LBS)
EUB2S36SL-1RD	36"	18"	12"	30"	40
EUB2S36SL-1LD	36"	18"	12"	30"	40
EUB2S48SL-1RD	48"	18"	24"	30"	67
EUB2S48SL-1LD	48"	18"	24"	30"	67
EUB2S48SL-2D	48"	18"	13"	30"	65
EUB3S40SL	40"	18"	-	30"	52
EUB3S48SL-1RD	48"	18"	13"	30"	73
EUB3S48SL-1LD	48"	18"	13"	30"	73
EUB3S60SL-1RD	60"	18"	25"	30"	80
EUB3S60SL-1LD	60"	18"	25"	30"	80
EUB3S60SL-2D	60"	18"	13"	30"	90
EUB3S72SL-2D	72"	18"	19"	30"	100
EUB3S84SL-2D	84"	18"	25"	30"	107
EUB3S96SL-2D	96"	18"	31"	30"	133
EUB4S72SL-2D	72"	18"	13"	30"	101
EUB4S84SL-2D	84"	18"	19"	30"	115
EUB4S96SL-2D	96"	18"	25"	30"	127

WEIGHTS ARE SUBJECT TO ADDITIONAL PACKAGING

John Boos & Co. is constantly engaged in a program of improving products and therefore reserves the right to change specifications without prior notice.



3601 S. Banker St. • Effingham, IL 62401 • PO BOX 609 • quotes@johnboos.com

www.johnboos.com