

Item No.:	_____	Qty.:	_____
Model No.:	_____		
Project No.:	_____		

## Economy Series Wall Mounted Shelf

*Economy Wall Mounted Shelf with Stainless Steel Brackets*



- | 12"                                  | 14"                                  |
|--------------------------------------|--------------------------------------|
| <input type="checkbox"/> EWMS-12-24X | <input type="checkbox"/> EWMS-14-24X |
| <input type="checkbox"/> EWMS-12-36X | <input type="checkbox"/> EWMS-14-36X |
| <input type="checkbox"/> EWMS-12-48X | <input type="checkbox"/> EWMS-14-48X |
| <input type="checkbox"/> EWMS-12-60X | <input type="checkbox"/> EWMS-14-60X |
| <input type="checkbox"/> EWMS-12-72X | <input type="checkbox"/> EWMS-14-72X |
| <input type="checkbox"/> EWMS-12-84X | <input type="checkbox"/> EWMS-14-84X |
| <input type="checkbox"/> EWMS-12-96X | <input type="checkbox"/> EWMS-14-96X |

### Features

- 18 Gauge, 430 series stainless steel
- Turned down on front & sides, turned up 1-1/2" at rear
- Includes stainless steel wall brackets
- Welded construction for consistent metal gauge thickness throughout
- Shipped knocked down for reduced shipping costs

### Materials

- **Shelf:** 18 Gauge, 430 series stainless steel
- **Brackets:** Stainless steel

### Options

- Bracket Upgrades / Modifications
- Edge Modifications
- Shelf Modifications
- Undershelves

### Flyer Product



**AUTOQUOTES**



*In keeping with our policy of continuing product improvement, Elkay SSP reserves the right to change product specifications without notice.*

*This specification describes an Elkay SSP product with design, quality and functional benefits to the user. When making a comparison of other producers' offerings, be certain these features are not overlooked.*



Item No.: \_\_\_\_\_ Qty.: \_\_\_\_\_  
 Model No.: \_\_\_\_\_  
 Project No.: \_\_\_\_\_

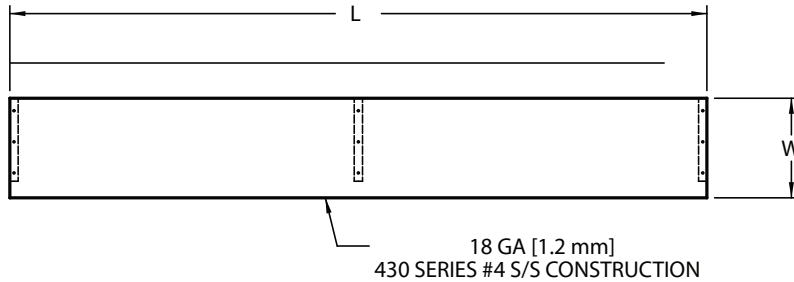

NOTE:  
BRACKETS SHIP LOOSE  
SHELF ATTACHES TO BRACKETS  
WITH SILICONE OR CONSTRUCTION  
ADHESIVE

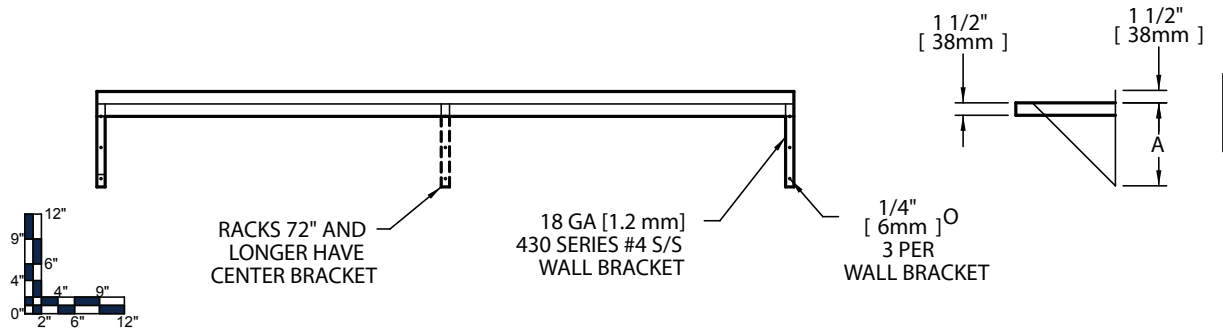

12" Shelf				14" Shelf					
Model Number	Overall Length L		Weight		Model Number	Overall Length L		Weight	
	in.	mm	lbs.	kg		in.	mm	lbs.	kg
EWMS -12 -24 X	24	914	8	4	EWMS -14 -24 X	24	914	12	5
EWMS -12 -36 X	36	914	11	5	EWMS -14 -36 X	36	914	15	7
EWMS -12 -48 X	48	1219	14	6	EWMS -14 -48 X	48	1219	18	8
EWMS -12 -60 X	60	1524	16	7	EWMS -14 -60 X	60	1524	21	10
EWMS -12 -72 X	72	1829	20	9	EWMS -14 -72 X	72	1829	25	11
EWMS -12 -84 X	84	2134	23	10	EWMS -14 -84 X	84	2134	30	14
EWMS -12 -96 X	96	2438	26	12	EWMS -14 -96 X	96	2438	33	15

\* Custom sizes also available

