



America's Oldest Stove Company
(Est. 1838)

JOB _____ ITEM # _____

Base Models: F318, F32

24" Wide Ranges



F32

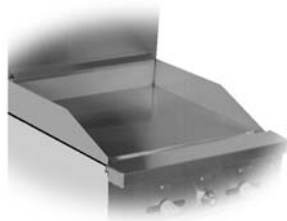

-24



-2RB

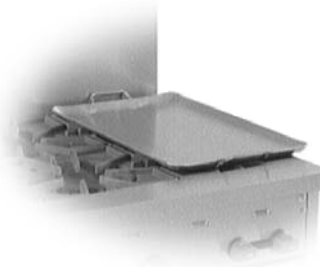

Log2
(lift off griddle)



F318

Standard Features & Benefits

OVEN: 19.5"w x 22"d x 14"h for superior baking characteristics and results. Heavy insulation for fuel efficiency. Easy cleaning porcelain and aluminized linings with one nickel plated rack. 3 rack positions with 2 3/4" between rack positions. Long life, 25,000 BTU cast iron "H" pattern oven burner combined with special "V" shaped baffle directs heat for excellent air circulation.

COOK TOPS: 24,000 BTU "star" pattern top burners with no gaskets to leak. The large 7" flame spread offers a more efficient burn pattern for small to large pots. Full width crumb trays catch all spillage. Top grates are 12" x 12" cast iron with spillover bowl that also reflects heat for added efficiency. Designed for easy movement of pots across top sections. Stainless steel bullnose-rail is safely flush with the cook tops and functional to straddle pots, skillets and plates and also serves as control protection.

CONSTRUCTION: Easy cleaning, corrosion resistant stainless steel finish, welded with angle iron and aluminized inner framing. Sturdy 6" heavy duty stainless pipe legs with adjustable feet. Double wall construction with heavy insulation for cooler operation. Installation clearances for non-combustible surfaces are 0" on sides and 0" in the rear, combustible surface clearances are 2" and 2".

CONTROLS: Includes 500° thermostat, 100% safety shut off, automatic standing pilot and brass top burner valves. Pressure regulators are set at the factory for the gas specified. Optimal pressures are 4" WC for natural gas and 10" WC for propane. Manifold size is 3/4" NPT. All controls are tested and confirmed in good working order. Calibration and adjustments are the responsibility of the buyer.

Optional Features

GRIDDLE PLATES: 12" or 24" wide, 3/4" thick. Long life 20,000 BTU cast iron burners. Front draining grease trough and large capacity grease catch. Optional 12" & 24" raised griddle-cheesemelters feature stainless steel wire mesh radiants and rear grease drains. 12" rated 20,000 BTU, 24" rated 30,000 BTU. Maximum rack clearance is 4 1/2".

CHAR-BROILERS: 25,000 BTU cast iron "H" pattern burners. Cast iron top grate sections fit into 12" width increments. A cast-in trough on each blade channels grease into the front cold zone grease trough reducing flare up. Each section is reversible for sloped or level cooking. Stainless steel splash guards on 3 sides graduating up to 4" high. Grease slot is 3.5" x 1" and feeds into a large, removable grease drawer. Char-broilers are approved for use in non-combustible locations only.

HOT TOPS: Available in 12" width increments in lieu of open top burners. 3/4" thick to hold heat from long life, even heating 20,000 BTU cast iron "H" pattern burners.

ACCESSORIES & OPTIONS: Casters, extra racks, pizza decks, FD oven thermostats, oven spark pilots, chrome griddle plates, 1" thick griddle plates, griddle thermostats, safety pilot griddles, lift off griddles, grill scrapers, cleaning supplies, hose and quick disconnects, control protection bars, storage base in lieu of oven and low backs are some of the standard options and accessories available.







Comstock-Castle Stove Co. • 119 W. Washington • Quincy, IL 62301 USA
Tel.: 217-223-5070 • Telefax: 217-223-0007 • www.castlestove.com

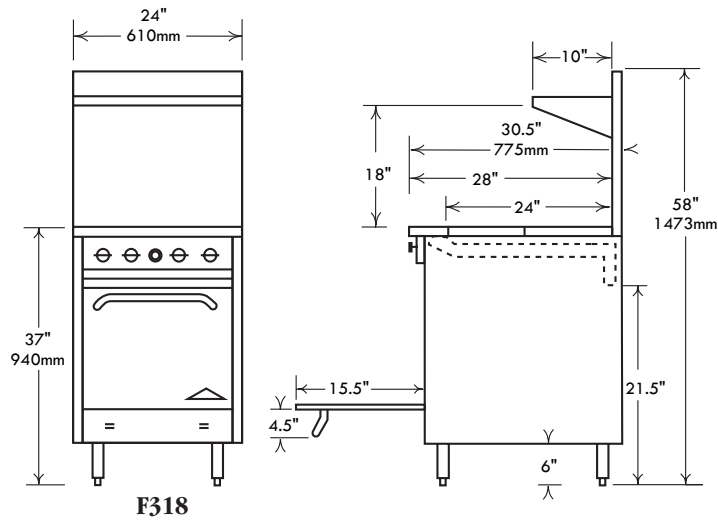

24" WIDE SERIES MEASUREMENTS



24" Restaurant Range Series

Top Configuration	Model #	Description		Total B.T.U.	Approx. Ship Weight	
		Top	Base		(Kg)	(Lbs.)
	F318	(4) Open Burners	- w/ (1) 19.5" Oven	121,000	143	315
	F32	(4) Open Burners	- w/ (1) cabinet base	96,000	102	225
	F318-12	(2) Open Burners	- w/ (1) 19.5" Oven	93,000	164	360
	F32-12	& (1) 12" Griddle	- w/ (1) cabinet base	68,000	118	260
	F318-12B*	(2) Open Burners & (1) 12" griddle, 9" cheesemelter	- w/ (1) 19.5" Oven	69,000	170	374
	F318-1RB	(2) Open Burners	- w/ (1) 19.5" Oven	98,000	159	350
	F32-1RB	& (1) 12" Radiant Broiler	- w/ (1) cabinet base	73,000	120	265
	F318-24	(0) Open Burners	- w/ (1) 19.5" Oven	65,000	182	400
	F32-24	& (1) 24" Griddle	- w/ (1) cabinet base	40,000	141	310
	F318-24B*	(0) Open Burners & (1) 24" griddle, 9" cheesemelter	- w/ (1) 19.5" Oven	55,000	180	396
	F318-2RB	(0) Open Burners	- w/ (1) 19.5" Oven	75,000	170	375
	F32-2RB	& (1) 24" Radiant Broiler	- w/ (1) cabinet base	50,000	132	290

Note: Radiant char-broiler sections and hot top available, add suffix -1RB, -2RB or -1HT, -2HT, etc. per section.

Top sections in lieu of open top burners are located on the right when viewing from the front. Special locations may require custom work and pricing, please call the factory for details.

Approximate Packaging Dimensions: 28" (711mm) Wide x 37" (940mm) Deep x 37" (940mm) High.

Product improvement is a Comstock-Castle policy and may result in design and specification change without notice.

Gas connection location as you look from the front: 21.5" from the floor, 3" from the left side.

* not ETL design listed