

Project: _____	AIA# _____
Item #: _____ Qty: _____	SIS# _____
Model #: _____	

Bridge Towers

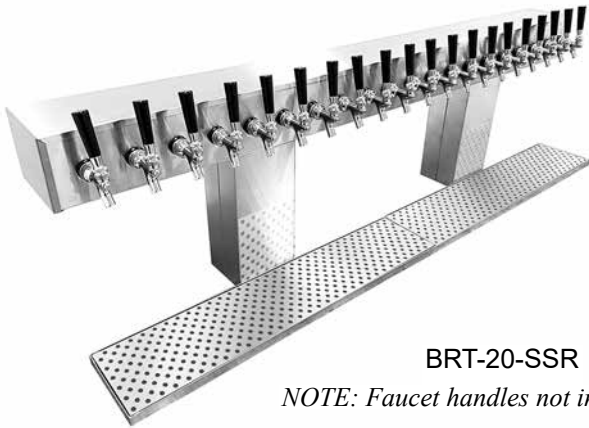

BRT-20-SSR

NOTE: Faucet handles not included.

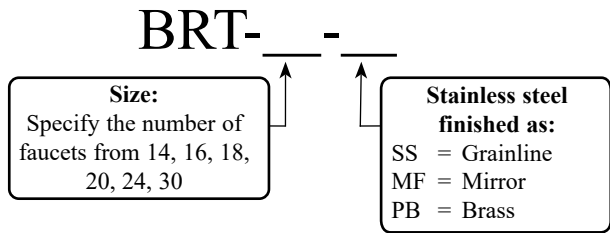

Standard Features

- All stainless steel construction
- Direct-draw air-cooled option available for 14, 16, and 18 faucet sizes* (*Note: Product is not intended for remote air-cooled installations)
- Surface mount drain pans with lift-out perforated inserts
- 1/4" shanks with 3/16" restriction lines
- Available in grainline finish, mirror finish, or brass finish* (*Note: Brass finish towers provided with mirror finish drain pan and brass finish perforated insert)
- Available with insulated cold plate assembly for recirculating system
- Eco friendly foamed-in-place insulated column for extra rigidity. Eco friendly foamed-in-place insulation has zero impact on global warming or ozone depletion
- All models include all stainless steel faucets and shanks
- Available with rinsers faucet extension to the left or right of the drain pan. Specify RFE accessory



Optional Rinsers Faucet Extension -RFE

To view cleaning and care instructions, please visit: https://www.glastender.com/PDF/F-423-011_ss_clean_care.pdf

Specifications

Drains

- Drain pan models - 1/2" tailpiece

Materials

- 20 gauge stainless steel parts include: head, column, drain pan, and perforated inserts
- 16 gauge galvanized steel parts include: interior foamed box
- 11 gauge stainless steel parts include: inner column base and top plate and tower head mounting plate

Shank Sizes

- 1/4" I.D. with 3/16" fittings

Rinsers Faucet (optional)

- Accepts 3/8" cold water lead
- 30 psi water pressure regulator included
- 1.2 gallons per minute

NOTE: Rinsers faucets are not intended for use with towers mounted to a refrigerator due to risk of water line freeze up.

Rinsers Faucet Installation Notes

- Important: Unit must be installed in conformance with applicable federal, state, and local plumbing codes, including adequate backflow when required.
- Must install backflow prevention device conforming to ANSI/ASSE 1022 or ANSI/ASSE 1024 to meet plumbing code (not included).
- Install in-line water regulator (included).
- A separate shut-off valve is recommended (not included).



Glastender, Inc. • 5400 North Michigan Road • Saginaw, MI • 48604-9780
989.752.4275 • 800.748.0423 • Fax 989.752.4444
www.glastender.com

Approval/Notes:

Specifications subject to change without notice. For current specifications please visit our website.

Bridge Towers

Dimensional Information

DOUBLE COLUMN BRIDGE TOWER				
FAUCETS	14	16	18	20
"A" WIDTH	44"	50"	56"	62"
"B" WIDTH	21"	24"	27"	30"
"C" WIDTH	Each rinser faucet adds 5" to drain pan width			

DOUBLE COLUMN BRT PLAN VIEW

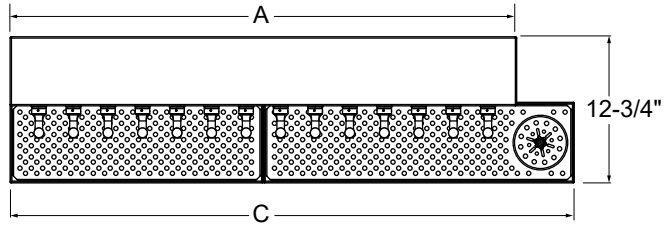

BRT FRONT ELEVATION

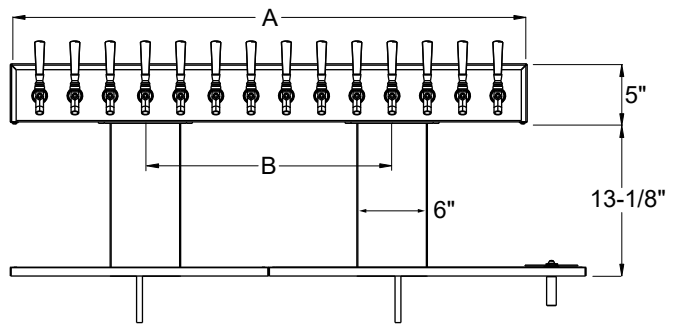

SHOWN WITH OPTIONAL RINSER FAUCET

BRT SIDE VIEW

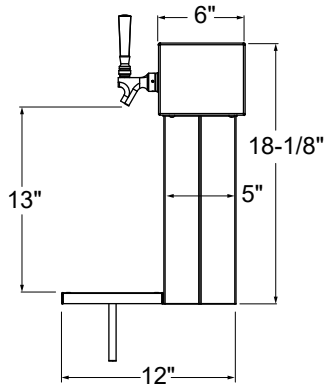

TRIPLE COLUMN BRT PLAN VIEW

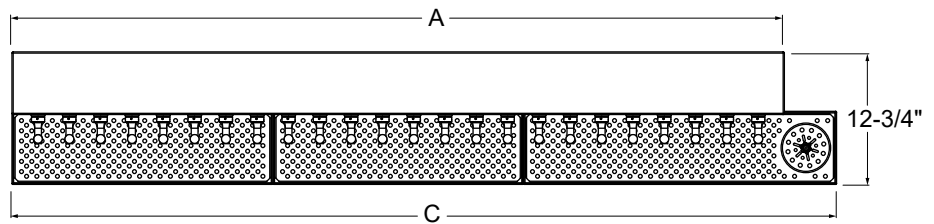

BRT FRONT ELEVATION

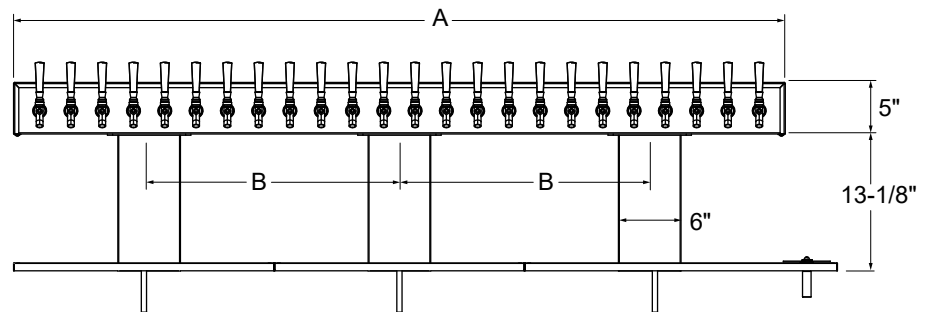

SHOWN WITH OPTIONAL RINSER FAUCET

TRIPLE COLUMN BRIDGE TOWER		
FAUCETS	24	30
"A" WIDTH	74"	92"
"B" WIDTH	24"	30"
"C" WIDTH	Each rinser faucet adds 5" to drain pan width	