

40 HAND SINK

Hand Sink Units w/Towel & Soap Dispenser



Without Manufacturer's Product Approval from the Massachusetts Board of State Examiners of Plumbers and Gasfitters

Hand Sink

40



AA-410G AA-138

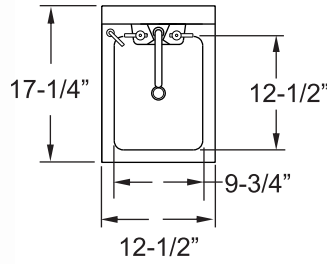

HS-1217TSSG

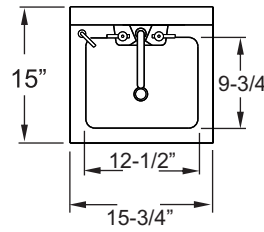

HS-1615TSSG

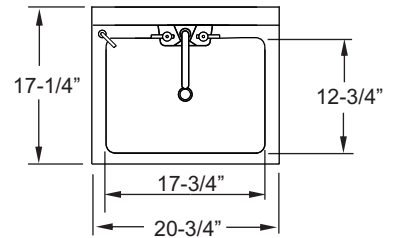

HS-2017TSSG

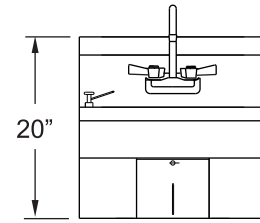
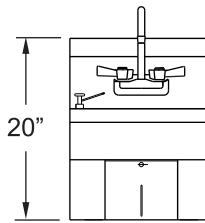
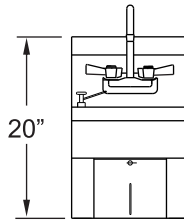

Order No	Description	Weight lbs/case	Pack/case
HS-1217TSS	Space Saver Under Mount Paper Towel & Deck Mount Soap Dispenser	26	1
HS-1615TSS	Standard Under Mount Paper Towel & Deck Mount Soap Dispenser	26	1
HS-2017TSS	Extra Wide Under Mount Paper Towel & Deck Mount Soap Dispenser	32	1
AA-138	Soap Dispenser 9 OZ Deck Mount for Hand Sink	1.2	1

“G” Model
include No Lead Faucet

Knee Operated Unit & With Welded Splash Guards



HS-1615K



HS-1615KSS

“G” Model
include No Lead Faucet

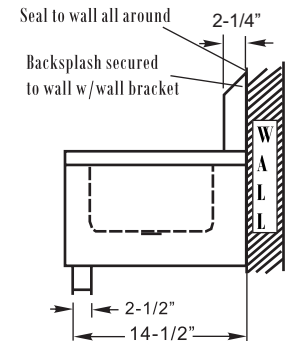
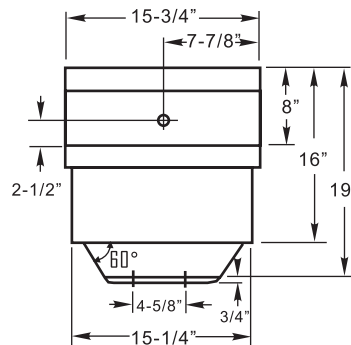
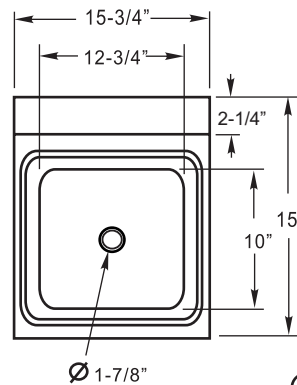

AA-515G



AA-203G



AA-138

Order No	Description	Weight lbs/case	Pack/case
HS-1615K	Hand Sink w/Knee Operated Valve	21	1
HS-1615KSS	Hand Sink w/Knee Operated Valve & Guards	23.4	1