

HOSHIZAKI

Series

HNC Series
Item # 13027
703

HNC SERIES



HNC-150-R(L)

- Top glass angles down
- Ceiling easier to clean
- NSF approved thermometer
- 80 Degrees F maximum ambient
- Large diameter 1 inch drains at front
- Load line is 3.5 inches above the floor
- Larger front to back interior, 11 inches
- Interior floor has a radius at all four sides
- Self-contained refrigeration unit -easy to install
- Condenser airflow is in the back and out the side
- Large diameter upper evaporator with tin plating
- Solid food plates with radius groove to fit sushi foods
- Larger condenser face area improves cooling performance
- Slightly taller doors with plastic seal at end, opposite of the handle
- Food plates can be turned upside down and used to improve cooling performance

HNC-120AA
Right or Left Handed
HNC-150AA
Right or Left Handed
HNC-180AA
Right or Left Handed
HNC-210AA
Right or Left Handed

Model Name

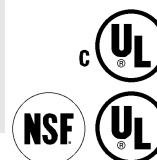
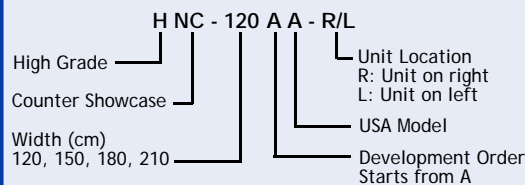

Reliability is a beautiful thing™

© HOSHIZAKI AMERICA, INC.

618 Hwy. 74 S., Peachtree City, GA30269

TEL1-800-438-6087

FAX 1-800-345-1325

www.hoshizaki.com

COUNTER TOP REFRIGERATED DISPLAY CASE

COUNTER TOP REFRIGERATED DISPLAY CASE

HNC-120A (RIGHT OR LEFT HANDED)
 HNC-150A (RIGHT OR LEFT HANDED)
 HNC-180A (RIGHT OR LEFT HANDED)
 HNC-210A (RIGHT OR LEFT HANDED)

- Top glass angles down for easy viewing and cleaning
- Larger condenser face area improves cooling performance



WARRANTY ONEYEAR - Parts & Labor on entire unit. TWOYEAR - Parts & Labor on compressor, Evaporator, Air-Cooled Condenser FIVEYEAR - Parts on: Compressor; Air-Cooled Condenser	R - 134A REFRIGERANT	SERVICE Removable/cleanable air filters.

Warranty valid in United States, Canada, Puerto Rico, & U.S. Territories. Contact Factory for Warranty in other Countries.

OPERATING LIMITS Ambient Temp Range 50 - 86°F Voltage Range 104 - 126V Saturation Temp. 39°F (80°F Ambient Temperature)	ELECTRICAL 115/60/1
--	-------------------------------

HOSHIZAKI COUNTER SHOW CASE				
Model	HNC-120AA-L(R)	HNC-150AA-L(R)	HNC-180AA-L(R)	HNC-210AA-L(R)
AC Supply Voltage	1 Phase 115V 60Hz			
Power Supply Capacity	0.47KVA (4.7A)			
Rated Amperage	3.0A			
Starting Amperage	13A			
Electric Consumption	195W			
Saturation Temperature	Approx. 39°F (Ambient Temp. 80°F, No Load)			
Net Capacity	1.48 ft ³	2.01 ft ³	2.54 ft ³	3.07 ft ³
Ambient Temperature	50 - 80°F			
Voltage Variation	Rated Voltage ±10%			
Exterior Dimensions (W) (D) (H)	47 1/4 inches 13 1/2 inches 11 inches	59 inches	71 inches	82 3/4 inches
Interior Dimensions (W) (D) (H)	33 1/4 inches 11 1/4 inches(bottom) 6 1/8 inches	45 inches	56 3/4 inches	68 3/4 inches
Exterior	Glass, ABS Plastic,PVC Plastic,Galvanized Steel			
Interior	Glass, ABS Plastic,Stainless Steel			
Insulation	Polyurethane Foam			
Refrigeration System	Convection Cooling			
Sliding Door	2 pieces	4 pieces		
Net Weight/ Shipping Weight	66 lb. / 82 lb.	79 lb. / 99 lb.	92 lb. / 117 lb.	106 lb. / 134 lb.
Shipping Dimensions (W) (D) (H)	50 1/2 inches 16 1/4 inches 16 inches	62 1/4 inches	74 inches	86 inches
Accessories - Food Mount Plug Vinyl Hose Joint	3 pieces 4 pieces 1 piece 2 pieces	4 pieces	5 pieces	6 pieces

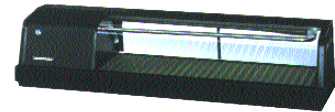
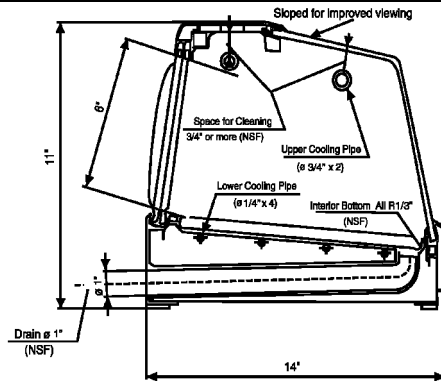

HNC-120AA-L

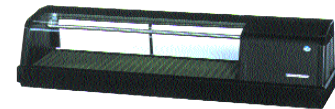

HNC-120AA-R

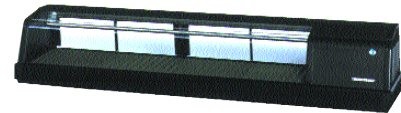

HNC-150AA-R(L)

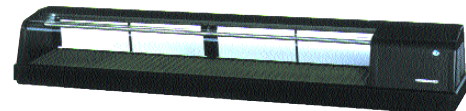

HNC-180AA-R(L)

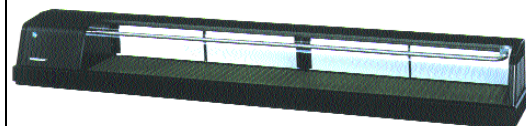

HNC-210AA-L(R)

Service cabinet, not for overnight storage

We reserve the right to change specifications without notice.