

KM-1601S_H(3)

STACKABLE CRESCENT CUBER

Item # _____

Project: _____

Qty: _____
 *AutoCad available on KCL

KM-1601S_H(3)

11/13

Item # 13204

CUBER DIMENSIONS

W x D x H

KM-1601S_H(3)
 48 x 27^{3/8} x 27^{3/8}

CONDENSING UNIT DIMENSIONS

W x D x H

Installation Dimensions
URC-22F
 46^{3/8} x 17^{1/4} x 40^{1/2}*
 *with legs

Actual Dimensions
URC-22F
 46^{3/8} x 15^{11/16} x 26

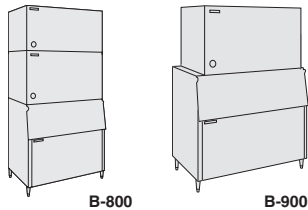

B-800

B-900

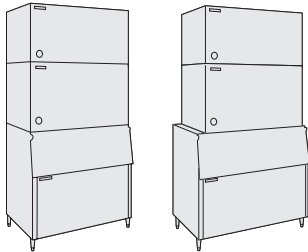

B-800

B-900

Also available on Large Bins:
 B-1150SS
 B-1300SS
 B-1500SS
 B-1650SS

*KM CUBE DIMENSIONS

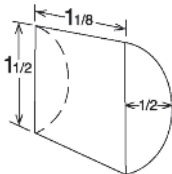

*approximate size in inches, image not to scale



KM-1601SAH

Air-Cooled 1 Phase

KM-1601SAH3

Air-Cooled 3 Phase

KM-1601SWH

Water-Cooled 1 Phase

KM-1601SWH3

Water-Cooled 3 Phase



KM-1601SRH

Remote Air-Cooled 1 Phase

KM-1601SRH3

Remote Air-Cooled 3 Phase

Shown on an optional
 B-900

- Up to 1555 lbs. of ice production per 24 hours
- Durable stainless steel exterior
- Individual crescent cube
- Protected by H-GUARD Plus Antimicrobial Agent 
- CycleSaver® Design 
- EverCheck® alert system 
- Stainless steel evaporator
- Stackable for 3170 lbs. of ice production in the same floor space
- R-404A Refrigerant

Warranty

Valid in United States, Canada, Puerto Rico, & U.S. Territories. Contact factory for warranty in other countries.

Three Year - Parts & Labor on entire machine.

Five Year - Parts & Labor on: Evaporator.

Five Year - Parts on: Compressor, air-cooled condenser coil.



© HOSHIZAKI AMERICA, INC.

618 Hwy. 74 S., Peachtree City, GA 30269

TEL 1-800-438-6087

FAX 1-800-345-1325

www.hoshizaki.com

A City Discount

KM-160IS_H(3) STACKABLE CRESCENT CUBER

DIMENSIONS
W x D x H
KM-160IS_H(3)
48 x 27^{3/8} x 27^{3/8}

Installation Dimension
URC-22F
46^{3/8} x 17^{1/4} x 40^{1/2}"
*with legs

Actual Dimension
URC-22F
46^{3/8} x 15^{11/16} x 26

AIR-COOLED | PHASE / 3 PHASE

Water Temp ° F.	50°	70°	90°
Air Temp ° F.			
70°	1462 / 1456	1427 / 1423	1307 / 1313
80°	1435 / 1431	1381 / 1381	1221 / 1234
90°	1427 / 1423	1343 / 1345	1198 / 1211

WATER-COOLED | PHASE / 3 PHASE

Water Temp ° F.	50°	70°	90°
Air Temp ° F.			
70°	1492 / 1555	1501 / 1558	1419 / 1466
80°	1499 / 1557	1513 / 1562	1378 / 1417
90°	1501 / 1558	1523 / 1565	1408 / 1440

REMOTE AIR-COOLED | PHASE / 3 PHASE

Water Temp ° F.	50°	70°	90°
Air Temp ° F.			
70°	1531 / 1530	1519 / 1521	1426 / 1414
80°	1522 / 1523	1503 / 1508	1368 / 1349
90°	1519 / 1521	1490 / 1498	1371 / 1359

UTILITY CONSUMPTION

Model Number	Ice Production Per Cycle		KWH per 100 LBS. 90/70	Potable Water Gal. per 100 lbs.	Condenser Water Gal. per 100 lbs.
	Lbs.	Cubes			
KM-1601SAH	31.4	1440	4.70	17.0	N/A
KM-1601SAH3	32.5	1440	4.65	18.5	N/A
KM-1601SWH	30.2	1440	3.8	24.5	98
KM-1601SWH3	30.2	1440	3.66	23.8	100
KM-1601SRH with URC-22F	31.6	1440	4.36	23.6	N/A
KM-1601SRH3 with URC-22F	32.1	1440	4.46	23.2	N/A

SPECIFICATIONS

Model Number	Condenser	Amperage	Min. Circuit Ampacity	Shipping Weight
KM-1601SAH	Air-Cooled	15.0	20	315 lbs.
KM-1601SAH3	Air-Cooled	12.0	20	315 lbs.
KM-1601SWH	Water-Cooled	13.4	20	360 lbs.
KM-1601SWH3	Water-Cooled	9.0	20	360 lbs.
KM-1601SRH	Remote Air-Cooled	12.8	20	350 lbs.
KM-1601SRH3	Remote Air-Cooled	7.9	20	350 lbs.

STORAGE BINS

Model Number	Application Capacity	ARI-Rated Capacity
B-800	800 lbs.	600 lbs.
B-900	900 lbs.	660 lbs.
B-1150	1150 lbs.	N/A
B-1300	1275 lbs.	N/A
B-1500	1500 lbs.	N/A
B-1650	1605 lbs.	N/A

ELECTRICAL & PLUMBING/KM-160IS_H(3)

- 208-230V/60/1(3 wire with dedicated neutral for 115V) / (208-230/60/3)
- 20 amp Max Fuse/HACR Breaker Size
- 1/2" OD copper or equivalent independent potable water supply
- 3/4" FPT independent drain connection



© HOSHIZAKI AMERICA, INC.

618 Hwy. 74 S., Peachtree City, GA 30269

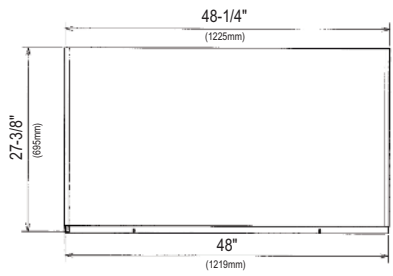

FRONT VIEW

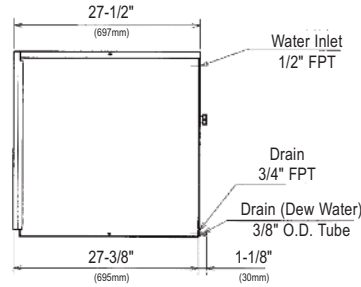

SIDE VIEW

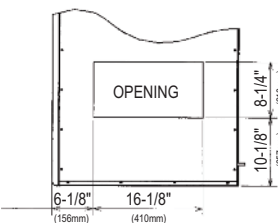

ICE DROP ZONE

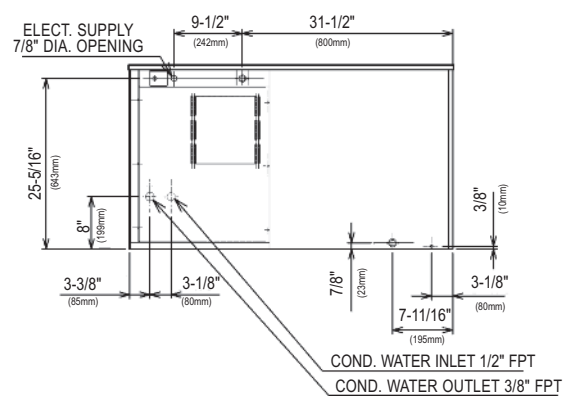

WATER-COOLED UNIT

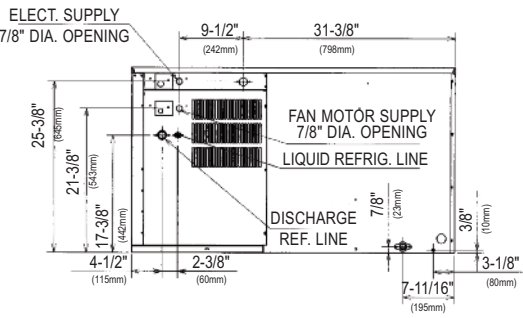

REMOTE AIR-COOLED UNIT

URC-22F Remote Condensing Unit (Sold Separately)
For Use with KM-1601SRH(3)

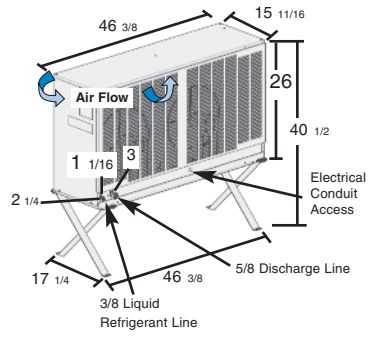

Pre-Charged Tubing Kit (Sold Separately)
20' R404-20610
35' R404-35610
55' R404-55610

Voltage supply for the URC Remote Condenser is supplied from the Ice Maker. No additional circuit is required.

OPERATING LIMITS

- Ambient Temp Range 45 - 100°F
- Water Temp Range 45 - 90°F
- Water Pressure 10 - 113psig
- Voltage Range 187 - 253V

SERVICE

- Panels easily removed and all components accessible for service.

CONDENSING UNIT

- Voltage Range 104 - 127V
- Ambient Temp Range -20 - 122°F

