

KM-1601MRH(3)

MODULAR CRESCENT CUBER

Item # _____

Project: _____

Qty: _____

*AutoCad available on KCL

KM-1601MRH(3)

11/13

Item # 13174

CUBER DIMENSIONS

W x D x H

KM-1601MRH(3)

30 x 27^{3/8} x 41^{11/16}

CONDENSING UNIT DIMENSIONS

W x D x H

Installation Dimensions

URC-22F

46^{3/8} x 17^{1/4} x 40^{1/2}*
*with legs

Actual Dimensions

URC-22F

46^{3/8} x 15^{11/16} x 26

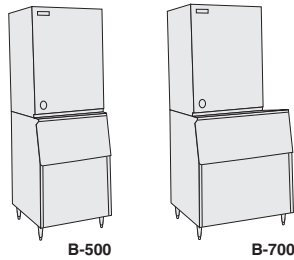

B-500

B-700

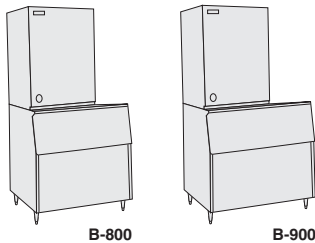

B-800

B-900

Also available on Large Bins:

B-1150SS

B-1300SS

B-1500SS

B-1650SS

*KM CUBE DIMENSIONS

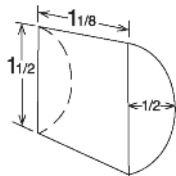

*approximate size in inches, image not to scale

KM-1601MRH



Remote 1 Phase

KM-1601MRH3

Remote 3 Phase

Shown on an optional
B-900



- Up to 1493 lbs. of ice production per 24 hours
- Durable stainless steel exterior
- Individual crescent cube
- Protected by H-GUARD Plus Antimicrobial Agent 
- CycleSaver® Design 
- EverCheck® alert system 
- Stainless steel evaporator
- R-404A Refrigerant

* The KM-1601MRH3 is ENERGY STAR qualified.

Warranty

Valid in United States, Canada, Puerto Rico, & U.S. Territories. Contact factory for warranty in other countries.

Three Year - Parts & Labor on entire machine.

Five Year - Parts & Labor on: Evaporator.

Five Year - Parts on: Compressor, air-cooled condenser coil.



© HOSHIZAKI AMERICA, INC.

618 Hwy. 74 S., Peachtree City, GA 30269

TEL 1-800-438-6087

FAX 1-800-345-1325

www.hoshizaki.com

A City Discount

Hoshizaki

KM-1601MRH(3) MODULAR CRESCENT CUBER

DIMENSIONS

W x D x H
KM-1601MRH(3)
30 x 27^{3/8} x 41^{11/16}

Installation Dimension
URC-22F
46^{3/8} x 17^{1/4} x 40^{1/2}

*with legs

Actual Dimension
URC-22F
46^{3/8} x 15^{11/16} x 26

REMOTE AIR-COOLED

Water Temp° F.	50°	70°	90°
Air Temp° F.			
70°	1493	1471	1410
80°	1476	1441	1364
90°	1471	1417	1346

REMOTE AIR-COOLED 3 PHASE

Water Temp° F.	50°	70°	90°
Air Temp° F.			
70°	1486	1458	1366
80°	1465	1422	1300
90°	1458	1391	1280

UTILITY CONSUMPTION

Model Number	Ice Production Per Cycle		KWH per 100 LBS. 90/70	Potable Water Gal. per 100 lbs.	Condenser Water Gal. per 100 lbs.
	Lbs.	Cubes			
KM-1601MRH with URC-22F	27.9	1440	4.64	18.6	N/A
KM-1601MRH3 with URC-22F	28.3	1440	4.55	19.2	N/A

SPECIFICATIONS

Model Number	Condenser	Amperage	Min. Circuit Ampacity	Shipping Weight
KM-1601MRH	Remote Air-Cooled	11.6	20	316 lbs.
KM-1601MRH3	Remote Air-Cooled	8.4	20	316 lbs.

STORAGE BINS

Model Number	Application Capacity	ARI-Rated Capacity
B-500	500 lbs.	360 lbs.
B-700	700 lbs.	550 lbs.
B-800	800 lbs.	600 lbs.
B-900	900 lbs.	660 lbs.
B-1150	1150 lbs.	N/A
B-1300	1275 lbs.	N/A
B-1500	1490 lbs.	N/A
B-1650	1605 lbs.	N/A

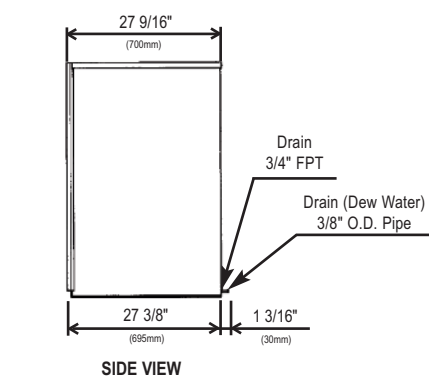
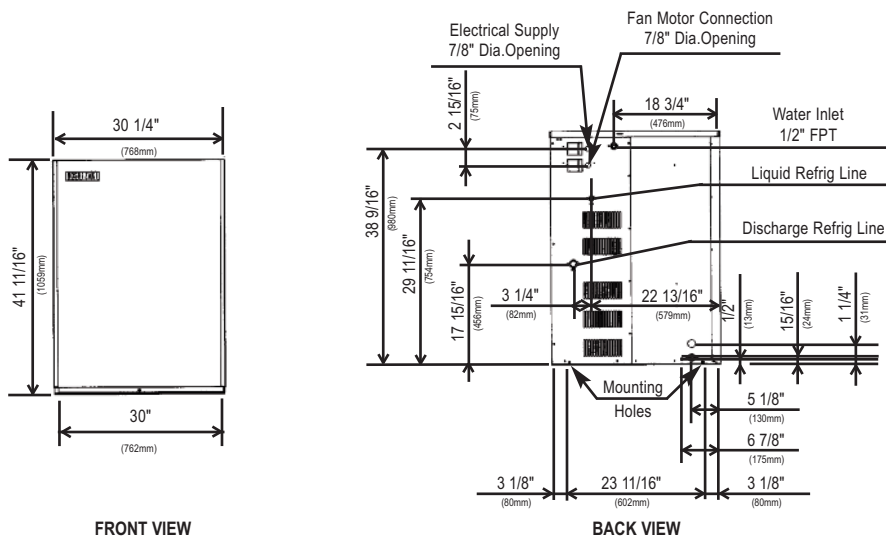

URC-22F Remote Condensing Unit (Sold Separately)
For Use with KM-1601MRH(3)

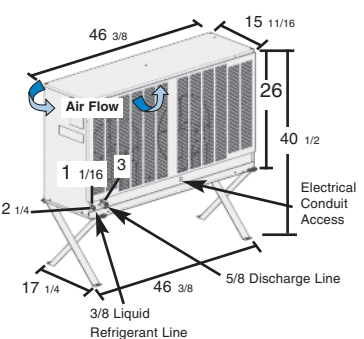

Pre-Charged Tubing Kit
(Sold Separately)
20' R404-20610
35' R404-35610
55' R404-55610

Voltage supply for the URC Remote Condenser is supplied from the Ice Maker. No additional circuit is required.

ELECTRICAL & PLUMBING/KM-1601MRH(3)

- 208-230V/60/1/3 wire with dedicated neutral for 115V / (208-230/60/3)
- 20 amp Max Fuse/HACR Breaker Size
- 1/2" OD copper or equivalent independent potable water supply
- 3/4" FPT independent drain connection

OPERATING LIMITS

- Ambient Temp Range 45 - 100°F
- Water Temp Range 45 - 90°F
- Water Pressure 10 - 113psig
- Voltage Range 187 - 253V

SERVICE

- Panels easily removed and all components accessible for service.

CONDENSING UNIT

- Voltage Range 104 - 127V
- Ambient Temp Range -20 - 122°F



© HOSHIZAKI AMERICA, INC.

618 Hwy. 74 S., Peachtree City, GA 30269

