



Model: **DX-316** Item #: _____ Date: _____
 Project: _____ Qty: _____ Approved By: _____

4" Deck Mount Faucet with 16" Swing Spout

DIAMOND
series

DESCRIPTION

4" Center Deck Mount Faucet with 16" Swing Spout, Ultra-Polish Satin Finish, 1.8 GPM Female Aerator Installed



STANDARD FEATURES

- 1/4 turn stainless steel high performance ceramic cartridge valves with built-in check valves
- Heavy duty flanges with eccentric fittings and flange seal technology
- Lever handles
- Mounting kit included
- E-Z install flexible water line kit included
- Lifetime Warranty

SPECIFICATIONS

Water Inlet	1/2" NPS Male
Temp. Range	40°F - 180°F
Pressure	20-120 PSI
Rough In	7/8" Round Holes on 8" Center
Flow Rate	1.8 GPM
Material	Solid Brass
Finish	Ultra-Polish Satin
Weight	5 lbs.

PRODUCT COMPLIANCE

- ASME A112.18.1/CSA B125.1
- NSF-61
- NSF/ANSI 372
- Meets ANSI A117.1 (ADA)

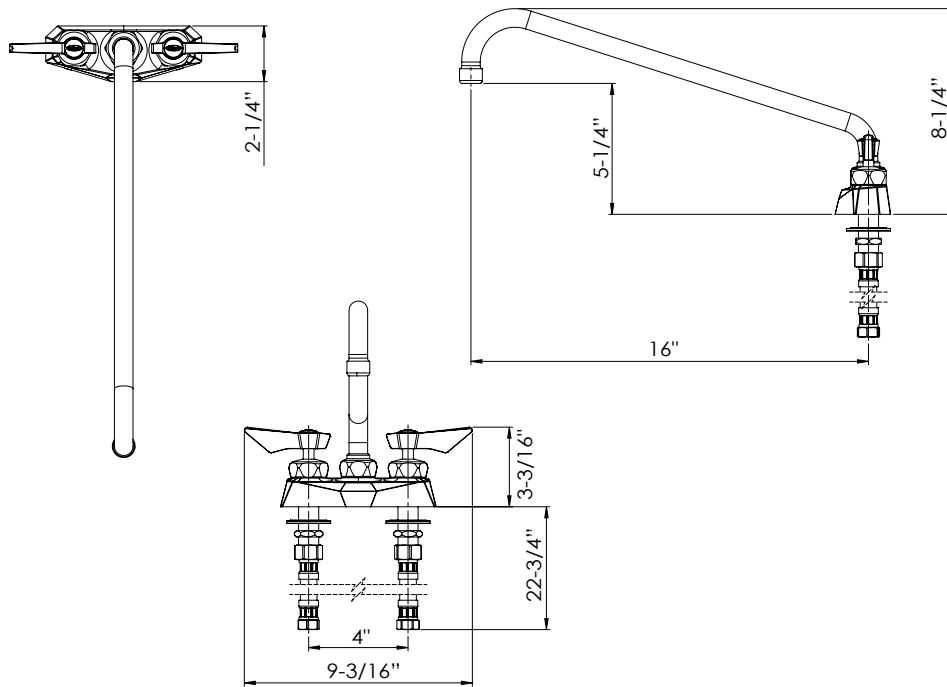

WARNING: Plumbing connections should be made by qualified personnel who will observe all applicable plumbing, sanitary and safety codes.
 California Proposition 65 Warning

Krowne Metal Corporation • 100 Haul Rd. Wayne, NJ 07470 • P: (800) 631-0442 • customerservice@krowne.com • krowne.com

Due to our commitment to continued product improvement, specifications are subject to change without notice.

Rev. 10/2021 • No. DX-316