

## ADVANTEDGE™ MEGA TOP SANDWICH FOOD PREP REFRIGERATORS



NLSMP48-18

PROJECT:  
 .....  
 ITEM NUMBER:  
 .....  
 MODEL NUMBER:  
 .....

SPECIFICATIONS FOR: NLSMP27-12, NLSMP36-15, NLSMP48-18, NLSMP60-24, NLSMP72-30

- **Finish:** Stainless steel interior and exterior.
- **Insulation:** Complete cabinet and doors are foamed-in-place with polyurethane insulation. Insulated pan cover.
- **Hardware:** Curved handle with recessed pocket and one epoxy coated shelf per door, 6" diameter casters standard.
- **Electrical:** 115 volt, 60 Hz, 1 phase with cord and plug.
- **Refrigeration:** Self-contained forced air refrigeration system. The condensate is collected and automatically evaporated from an energy efficient hot gas style vaporizer. Refrigerant flow is controlled by a capillary tube. R-134a refrigerant. Temperature range: +34°F to +38°F for storage area, +33°F to +41°F for refrigerated rail.
- **Accessories:** 1/6 size pans and 9-1/2" polyethylene cutting board included.
- **Approvals:** UL, C-UL and ETL Sanitation listed \*\*

### STANDARD FEATURES

- 1/6 size pans included  
 \*Note: NLSMP27-12 has (9) 1/6 size pans and (3) 1/9 size pans included.
- Air cooled condensing unit
- Automatic condensate vaporizer
- Automatic defrost
- Capillary tube system
- Casters
- Cutting board
- Magnetic gaskets
- Self-closing doors
- Stainless steel interior and exterior
- UL, C-UL and ETL Sanitation listed \*\*
- Warranties: 3 year parts & labor, 5 year compressor

### OPTIONAL FEATURES\*

- Additional shelves
- Overshelf assemblies
- Pull out drawers



Nor-Lake, Inc.  
 Registered to ISO 9001:2008  
 File No. 10001816

\* Most options are available two weeks from receipt of order. Please contact us for specific questions.  
 \*\* C-UL is Underwriters Laboratories Safety Certification Mark which indicates that UL has tested the equipment to applicable CSA Standards.  
 \*\* UL-Sanitation is Underwriters Laboratories Safety Certification Mark which indicates that UL has tested the equipment to applicable NSF Standards.

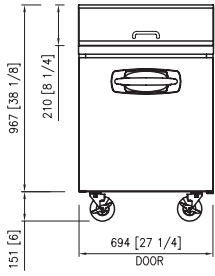

FRONT

NLSMP27-12

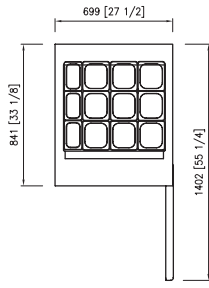

TOP

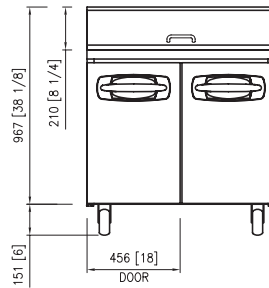

FRONT

NLSMP36-15

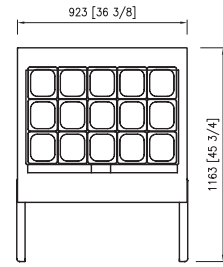

TOP

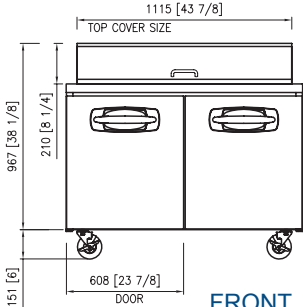

FRONT  
NLSMP48-18  
TOP

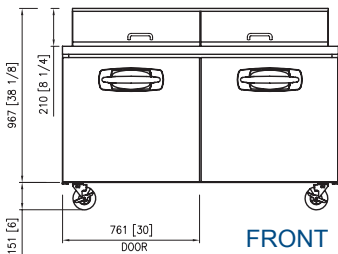
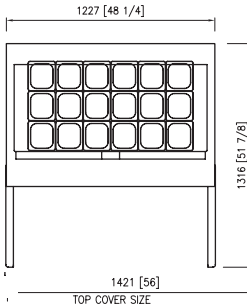

FRONT  
NLSMP60-24  
TOP

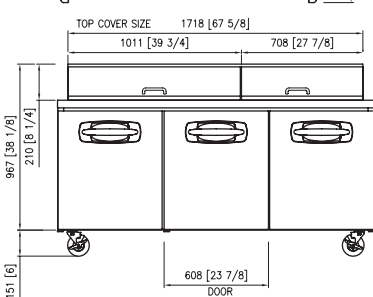
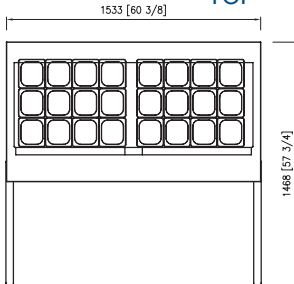

FRONT

NLSMP72-30

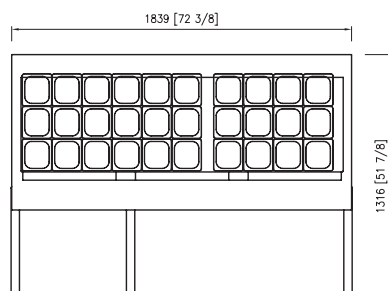

TOP

**SPECIFICATIONS**

Models	NLSMP27-12	NLSMP36-15	NLSMP48-18	NLSMP60-24	NLSMP72-30
Crated Weight (lbs) (kg)	223 (100)	284 (128)	318 (143)	362 (163)	399 (180)
Crated Height (in) (cm)	44-1/2 (111)	44-1/2 (111)	44-1/2 (111)	44-1/2 (111)	44-1/2 (111)
Crated Width (in) (cm)	30-1/8 (75)	37-1/4 (93)	51-1/8 (128)	63 (158)	74-3/8 (186)
Crated Depth (in) (cm)	35-1/5 (88)	35-3/8 (88)	35-3/8 (88)	35-3/8 (88)	35-3/8 (88)
Interior Height (in) (cm)	21-1/8 (53)	26-1/8 (65)	26-1/8 (65)	26-1/8 (65)	26-1/8 (65)
Interior Width (in) (cm)	23-3/4 (59)	32-3/4 (82)	44-5/8 (112)	56-3/4 (142)	68-5/8 (172)
Interior Depth (in) (cm)	20-1/4 (51)	20-1/4 (51)	20-1/4 (51)	20-1/4 (51)	20-1/4 (51)
Overall Height (in) (cm)	44-1/8 (110)	44-1/8 (110)	44-1/8 (110)	44-1/8 (110)	44-1/8 (110)
Overall Width (in) (cm)	27-1/2 (69)	36-3/8 (91)	48-1/4 (121)	60-3/8 (151)	72-3/8 (181)
Overall Depth (in) (cm)	35-1/4 (88)	35-1/4 (88)	35-1/4 (88)	35-1/4 (88)	35-1/4 (88)
Gross Cubage (CuFt) (L)	7 (198)	10 (283)	13 (368)	16 (453)	20 (566)
Number of 1/6 Pans	12 *	15	18	24	30
Number of Shelves	1	2	2	2	3
Shelf Area (SqFt) (Sqm)	4.82 (0.45)	7.02 (0.65)	9.25 (0.86)	12.35 (1.15)	14.19 (1.32)
Number of Casters	4	4	4	4	4
Condensing Unit Size	1/5 HP	1/5 HP	3/8 HP	3/8 HP	3/8 HP
Refrigerant	R-134a	R-134a	R-134a	R-134a	R-134a
Electrical Characteristics	115/60/1	115/60/1	115/60/1	115/60/1	115/60/1
Cord and Plug Furnished	Yes	Yes	Yes	Yes	Yes
NEMA Plug Configuration	5-15P	5-15P	5-15P	5-15P	5-15P
Total Amp Draw	3.2	3.4	7.9	7.9	9.9

Specifications subject to change without notice.

\* NLSMP27-12 has (9) 1/6 size pans and (3) 1/9 size pans included



Revision Date: 02/14  
©2014 NOR-LAKE, INC.  
Printed in the USA  
Part Number: 143381

