



"Over Shelves" E - Series

Model **"ES"** Single Stainless Steel Overshelf

Model **"ED"** Double Stainless Steel Overshelf

SINGLE



Single Over Shelf

Single Shelf		Double Shelves	
MODEL	LENGTH	MODEL	LENGTH
OS-ES-1248	12"X48"	OS-ED-1248	12"X48"
OS-ES-1260	12"X60"	OS-ED-1260	12"X60"
OS-ES-1272	12"X72"	OS-ED-1272	12"X72"
OS-ES-1296	12"X96"	OS-ED-1296	12"X96"



Double Over Shelf
w/ Adjustable
Mid Shelf

FEATURES:

- * Stainless Steel Shelf
18 gauge, type 430 stainless steel with # 3 polish, satin finish
- * Uprights are 1 1/4" O.D. Round 18 gauge tubing,
- * Square Turndown edge all four sides
- * Single Overshelves are mounted 18" above table top
- * Double Overshelves are mounted 18" above table top
with top shelf 12" above mid shelf
- * Mid shelf of double shelf units are Adjustable

CONSTRUCTION:

- * Stainless Steel Overshelves are TIG welded
Exposed welds are polished to match adjacent surfaces

MATERIAL:

- Shelf 18 gauge type 430 stainless steel, # 4 polish, satin finish
- Uprights: 1 1/4" Round O.D., 18 gauge type 430 tubular stainless steel
4 polish, satin finish

John Boos & Co

315 South First Street - Effingham, IL 62401

Phone: 217-347-7701 - Fax: 217-347-7705

Email: sales@johnboos.com - Web-site: www. johnboos.com

DETAILED SPECIFICATIONS

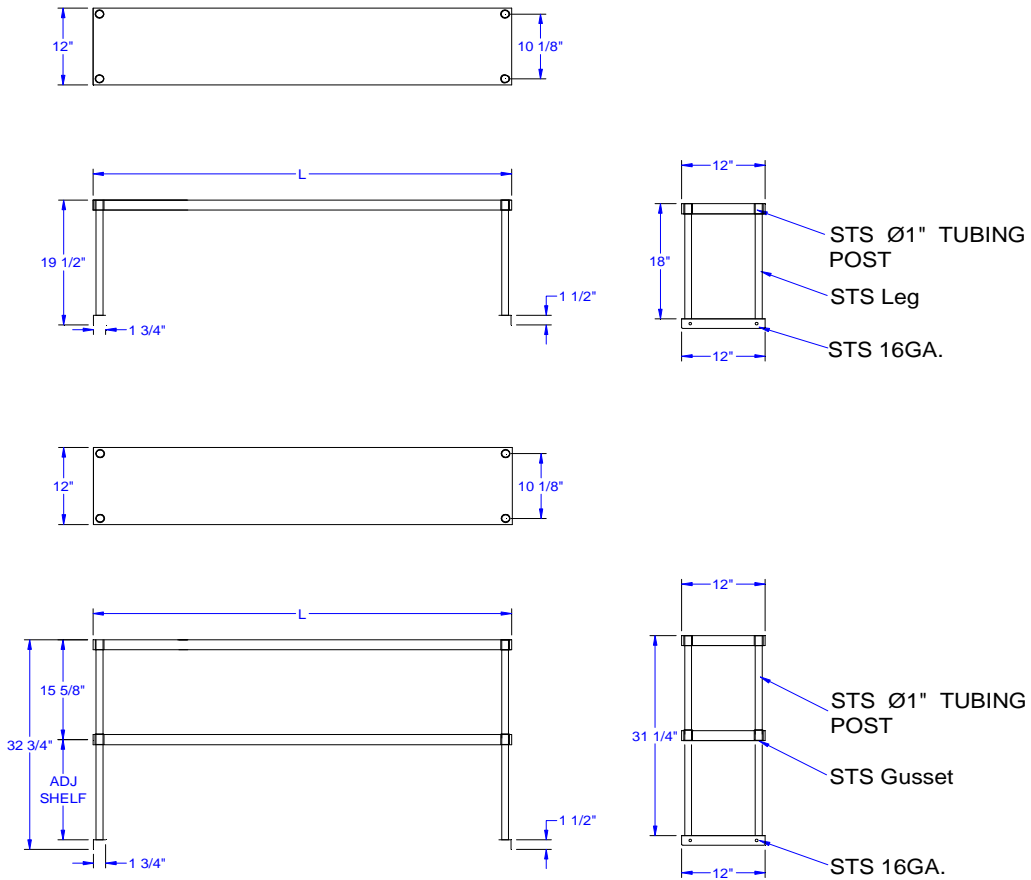

All dimensions are typical.
Tolerance +/- .500".

Single Shelf		
MODEL	LENGTH	WT.
OS-ES-1248	12"X48"	17
OS-ES-1260	12"X60"	21
OS-ES-1272	12"X72"	24
OS-ES-1296	12"X96"	40

Double Shelves		
MODEL	LENGTH	WT.
OS-ED-1248	12"X48"	31
OS-ED-1260	12"X60"	36
OS-ED-1272	12"X72"	40
OS-ED-1296	12"X96"	56

John Boos & Co
 315 South First - Effingham, IL 62401 Phone: 217-347-7701 - Fax: 217-347-7705
 Email: sales@johnboos.com - Web-site: www.johnboos.com



March 2011