

Item #: _____ **Qty #:** _____
Model #: _____
Project #: _____



Shown With
3 Tier Drawer Set Up



Revolutionary New SHD Series Drawer with Integral Drawer Slides

- Stainless Steel Front & Sides
- Self Closing Drawer with Noise Control
- Drawer "Safety Stop" Tab
- Removable Stainless Steel Inset
- Units Can Be Stacked to Create Multiple Tier Drawers
- Hardware Included
- NSF Approved



MODEL #	Width	Description	Inset
SHD-2015	17 1/2"	Stainless Steel	20" x 15" x 5"
SHD-2020	22 3/4"	Stainless Steel	20" x 20" x 5"

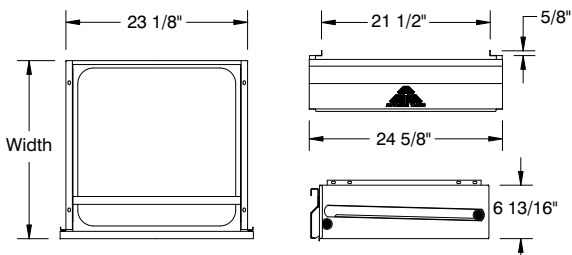

**Drawers Stack with Ease
to Create Tier Drawers!**
Easily installs in field

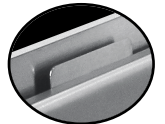

Features a
"Safety Stop" Tab

OPTIONAL CONCEALED SIDE PANELS For 20"x20" Drawers (1 for needed each side)



1 Tier Drawer:
TA-SHD-1 each side

2 Tier Drawers:
TA-SHD-2 each side

3 Tier Drawers:
TA-SHD-3 each side

SHD SERIES MODIFICATIONS & ACCESSORIES

- Concealed Side Panel for 20"x15" Drawer TA-2 ea.
- Drawer Lock TA-14SHD
- Pad Lock Hasp..... TA-13
- Drawers Modified To
15" L/R x 20" F/B TA-50
- Poly Board Storage Brackets
For SHD Drawers TA-97SHD
- 5/8" Thick Poly Board Cutting Boards
For SHD Drawers TA-41SHD ea.

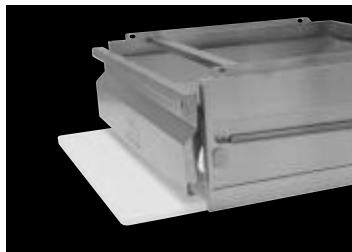

TA-97SHD Polyboard Storage Bracket
(Installs in field. Hardware Included)



Rear View of Multiple Stacked Drawers
Drawer Seam Exposed