



SR48A-12M/18M

Mega Top 48" Prep Refrigerator



SR48A-12M-18M
09/12/18
Item # 13471

W x D x H
48" x 34" x 44.25"*
*with 6" casters

SR48A-12M



SR48A-18M



Item #: _____

Project: _____

Qty: _____

AIA#: _____

Features

- ▶ Engineered to maintain NSF-7 temperatures in 100°F ambient. (Certified to NSF-7 temperatures in 86°F ambient.)
- ▶ Stainless steel exterior front, sides and top with stainless steel interior sides, back, and floor
- ▶ Front breathing air flow design
 - Environmentally friendly R290 hydrocarbon refrigerant
 - Cabinet and doors are insulated with 2" CFC free, foamed in place polyurethane
 - Exclusive "stepped" door design to protect door gasket
 - Spring assisted self-closing doors with stay open feature
 - Extruded aluminum flush mount door handle
 - Field reversible doors
 - Magnetic door gasket is easily removable for cleaning
 - Innovative air distribution system distributes air evenly to maintain product temperature
 - Provided with a full complement of polycarbonate plastic 1/6th size pans, 4" deep
 - Rails will also accept 6" deep pans for 50% more pan volume
 - 48" x 10" x 1/2" thick white polyethylene cutting board is standard
 - Removable stainless steel prep guard simplifies cleanup from accidental rail pan drips and spills
 - E-coated evaporator coil
 - One epoxy coated shelf per section is standard
 - Anodized aluminum shelf supports adjustable in 1/2" increments
 - Standard with 6" casters (two with brakes)
 - 10 ft. cord and plug

Dimensions / Capacity

	Two-Section SR48A-12M	Two-Section SR48A-18M
Interior Storage Capacity (CF)	13.66 ft ³	13.66 ft ³
Interior Storage Capacity (CF) (AHAM)	11.95 ft ³	11.95 ft ³
Overall Width x Depth (including 1" bumper)	48" x 35"	48" x 35"
Height (including 6" casters)	44.25"	44.25"
Depth with Cutting Board Installed	37.3"	37.3"
Door Opening Width x Height	19.5" x 23"	19.5" x 23"
Depth with Door Open at 90° (including 1" bumper)	52.5"	52.5"
Adjustable Shelves	2	2
Shelf Dimensions (W x D)	21.25" x 16"	21.25" x 16"
Pan Capacity (# of 1/6 size x 4" deep)	12	18
Crated Weight	295 lbs.	313 lbs.
Crated Length x Width x Height	52.5" x 36" x 46.5"	52.5" x 36" x 46.5"

Electrical / Refrigeration

	Two-Section SR48A-12M	Two-Section SR48A-18M
Voltage	115/60/1	115/60/1
HACR Breaker	15.0 Amps	15.0 Amps
Electrical Connection (NEMA)	5-15P	5-15P
Voltage Range	104-126	104-126
Ambient Temp. Range	45° to 100°F	45° to 100°F
Control Setpoint Range	32° to 52°F	32° to 52°F
Amperage	2.5	2.5
Energy Consumption (kWh/day) @NSF	3.2	3.2
Heat Rejection (BTU/Hr.) @NSF	452.3	452.3
Approx. Nominal Compres. BTU/HR (HP)	1354(1/5HP)	1354(1/5HP)
Refrigerant / Charge Amount (oz)	R290(2.9 oz)	R290(2.9 oz)

Options

- Stainless steel back
- Stainless steel lift of covers
- Additional epoxy shelves
- Composite cutting board (HS-5267)
- Stainless steel shelves
- Rail adapter bars
- 2.25" Casters
- 4" Casters
- Overshelves

Warranty

* 3 Year - parts and Labor on entire machine.
5 Year - Parts on Compressor
Valid in United States, Canada, Puerto Rico and U.S. Territories. Contact factory for warranty in other countries.

Hoshizaki reserves the right to change specifications without notice.



SR48A-12M/18M

Mega Top 48" Prep Refrigerator



SR48A-12M-18M
09/12/19
Item # 13471

FRONT VIEW

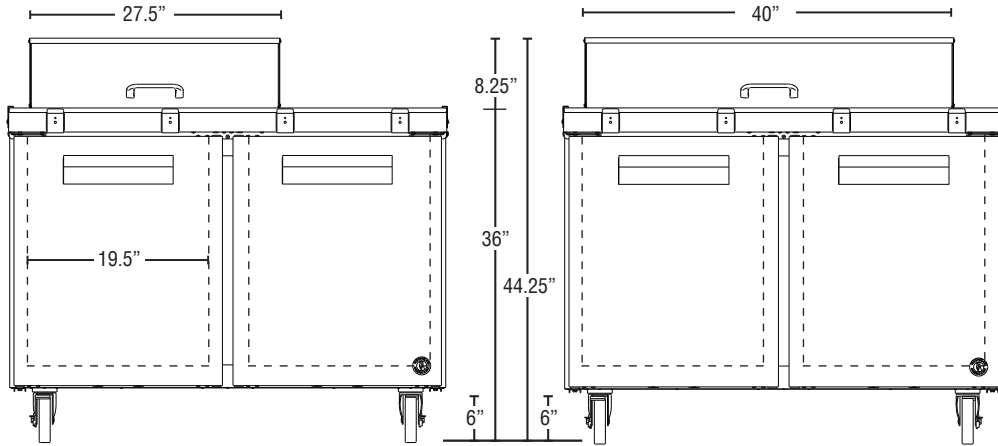

SR48A-12M

SR48A-18M

SIDE VIEW

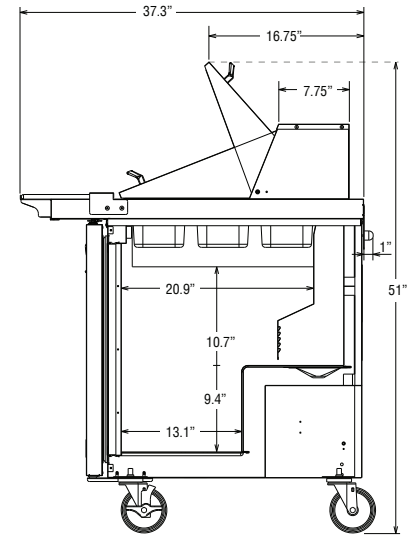

PLAN VIEW

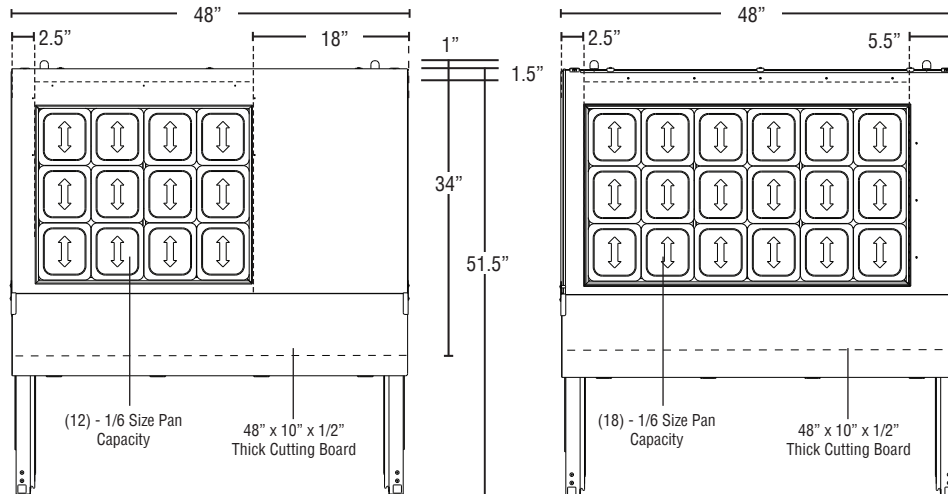

SR48A-12M

SR48A-18M

Cabinet Construction

The exterior cabinet top, front, and sides, are constructed of high quality stainless steel. Cabinet is provided with a stainless steel top enclosure and an easily removable stainless steel insulated lift-up cover. The exterior back and bottom are constructed of coated steel. The cabinet interior back and sides are stainless steel with an ABS ceiling and stainless steel floor. One heavy duty epoxy coated shelf per section is standard. Mounted on anodized aluminum pilasters the shelf is adjustable in 1/2" increments. Cabinet walls and doors are insulated with 2" CFC free, foamed in place polyurethane. 6" polyolefin, stem casters (two with brakes) are standard. Preparation tables are supplied with a 48" x 10" x 1/2" thick N.S.F. approved white polyethylene cutting board.

Door Construction

Doors are constructed of high grade stainless steel exterior with an ABS interior liner and insulated with 2" CFC free, foamed in place polyurethane. Hoshizaki's exclusive "stepped" design protects the gasket while product is removed from the cabinet. Doors are provided with a one piece, extruded aluminum, flush mount handle. Spring assisted self-closing doors are equipped with a stay open feature past 90 degrees. Snap-in magnetic door gaskets are durable and easily removed for cleaning. Field reversible door hinging is standard.

Refrigeration System

Front breathing refrigeration system allows unit to be built into any enclosure with zero side or rear clearance. The high efficiency refrigeration system is self-contained with an E-coated evaporator for extended life. Condensate removal is accomplished with an energy efficient non-electric evaporation system. A capillary tube controls the flow of environmentally friendly R290 refrigerant through the evaporator. Unit uses a heated, time initiated defrost to eliminate any ice on the evaporator coil. An innovative air distribution system distributes air evenly from beneath the pans. Engineered to maintain NSF-7 temperatures in 100°F ambient. (Certified to NSF-7 temperatures in 86°F ambient.) Preparation tables are supplied with a full complement of N.S.F. approved polycarbonate plastic 1/6th size pans, 4" deep and stainless steel adapter bars. Rail will also accommodate 6" deep pans. Pans are located 1.5" below the top to keep food product within easy reach. 115 volt units are equipped with a ten foot cord and NEMA rated plug (20.0 amps or less).