



REFRIGERATED CHEF BASE



NLCB72

SPECIFICATIONS FOR: NLCB36, NLCB48, NLCB53, NLCB60, NLCB72, NLCB84, NLCB96

- **Finish:** Complete stainless steel interior. Stainless steel exterior front, sides and heavy-duty marine edge top (except NLCB36). NLCB36 has a flat top. Galvanized bottom and back.
- **Insulation:** The complete cabinet and drawers are foamed in place with polyurethane insulation
- **Electrical:** 115 volt, 60 Hz, 1 phase with cord and NEMA 5-15P Plug
- **Hardware:** Heavy-duty stainless steel drawers supported on stainless steel telescoping drawer slides with stainless steel roller bearing wheels. Drawer slides designed to withstand maximum of 200 lbs per drawer. Full marine edge top to prevent spills from flowing over edge. Heavy-duty 4" casters. Drawers include notched locking pan adapter bars for full-size pans (pans not included).
- **Refrigeration:** Self-contained refrigeration system utilizes R-134a refrigerant metered by a capillary tube system. Automatic condensate evaporator. Interior forced air system with high humidity evaporator coils. Adjustable temperature control. Temperature range +34°F to +38°F. Digital temperature indicator.
- **Approvals:** UL, C-UL and ETL Sanitation listed **

*Most options are available one week from receipt of order. Please contact us for specific questions.

**C-UL is Underwriters Laboratories Safety Certification Mark which indicates that UL has tested the equipment to applicable CSA Standards.

**ETL Sanitation is Intertek Labs Sanitation Mark which indicates that ETL has tested the equipment to applicable NSF Standards.



STANDARD FEATURES

- Adjustable temperature control
- Automatic condensate evaporator
- Capillary tube system
- Digital temperature indicator
- Full marine edge top (except NLCB36)
- NLCB36 has a flat top
- Full size pan adapter bars (pans not included)
- 4" casters consuming 5"
- Stainless steel exterior finish
- Stainless steel interior finish
- Stainless steel drawers
- Temperature range: +34°F to +38°F
- UL, C-UL and ETL Sanitation listed **
- Warranties: 3 year parts & labor, 5 year compressor

OPTIONAL FEATURES*

- Legs

*Most options are available one week from receipt of order. Please contact us for specific questions.

**C-UL is Underwriters Laboratories Safety Certification Mark which indicates that UL has tested the equipment to applicable CSA Standards.

**ETL Sanitation is Intertek Labs Sanitation Mark which indicates that ETL has tested the equipment to applicable NSF Standards.

	<i>SPECIFICATIONS</i>						
<i>Models</i>	<i>NLCB36</i>	<i>NLCB48</i>	<i>NLCB53</i>	<i>NLCB60</i>	<i>NLCB72</i>	<i>NLCB84</i>	<i>NLCB96</i>
<i>Crated Weight (lbs) (kg)</i>	182 (87)	232 (105)	230 (104)	250 (113)	340 (153)	355 (160)	390 (180)
<i>Crated Height (in) (cm)</i>	27 (68)	27 (68)	27 (68)	27 (68)	27 (68)	27 (68)	27 (68)
<i>Crated Width (in) (cm)</i>	38 (97)	50 (127)	55 (138)	62 (155)	74 (185)	86 (215)	98 (245)
<i>Crated Depth (in) (cm)</i>	34 (85)	34 (85)	34 (85)	34 (85)	34 (85)	34 (85)	34 (85)
<i>Interior Height (in) (cm)</i>	16-1/2 (41)	16-1/2 (41)	16-1/2 (41)	16-1/2 (41)	16-1/2 (41)	16-1/2 (41)	16-1/2 (41)
<i>Interior Width (in) (cm)</i>	22-1/4 (57)	34-1/4 (87)	39-3/4 (99)	39-3/4 (99)	57-1/2 (144)	70-1/2 (176)	83-1/2 (209)
<i>Interior Depth (in) (cm)</i>	21-3/4 (54)	21-3/4 (54)	21-3/4 (54)	21-3/4 (54)	21-3/4 (54)	21-3/4 (54)	21-3/4 (54)
<i>Overall Height (in) (cm)</i>	25-1/2 (64)	25-1/2 (64)	25-1/2 (64)	25-1/2 (64)	25-1/2 (64)	25-1/2 (64)	25-1/2 (64)
<i>Overall Width (in) (cm)</i>	36 (92)	48 (122)	53 (133)	60 (150)	72 (180)	84 (210)	96-1/16 (240)
<i>Overall Depth (in) (cm)</i>	31 (78)	31 (78)	31 (78)	31 (78)	31 (78)	31 (78)	31 (78)
<i>Gross Cubage (CuFt) (L)</i>	5.7 (161)	8.6 (244)	9.8 (277)	9.8 (277)	14.3 (405)	17.2 (487)	21.4 (606)
<i>Full Size Pan Capacity**</i>	2	4	6	6	8	10	12
<i>Number of Drawers</i>	2	2	2	2	4	4	4
<i>Number of Casters</i>	4	4	4	4	6	6	6
<i>Total Weight / Load Capacity (lbs) (kg)</i>	1040 (468)	1040 (468)	1040 (468)	1040 (468)	1560 (702)	1560 (702)	1560 (702)
<i>Condensing Unit Size</i>	1/5 HP	1/5 HP	1/5 HP	1/5 HP	1/5 HP	3/8 HP	3/8 HP
<i>Refrigerant</i>	R-134a	R-134a	R-134a	R-134a	R-134a	R-134a	R-134a
<i>Electrical Characteristics</i>	115/60/1	115/60/1	115/60/1	115/60/1	115/60/1	115/60/1	115/60/1
<i>Cord and Plug Furnished</i>	Yes	Yes	Yes	Yes	Yes	Yes	Yes
<i>NEMA Plug Configuration</i>	5-15P	5-15P	5-15P	5-15P	5-15P	5-15P	5-15P
<i>Total Amp Draw</i>	3.3	3.3	3.3	3.3	3.3	6.0	6.0

Specifications subject to change without notice.

*** Pans not included.*



NLCB36

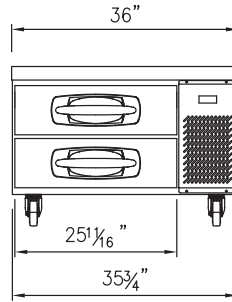

FRONT VIEW

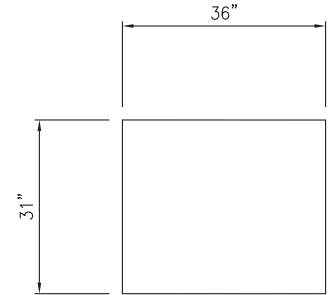

TOP VIEW



NLCB48

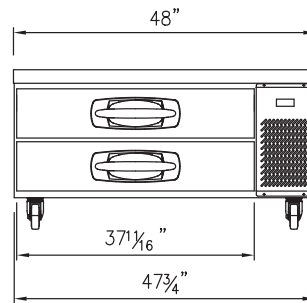

FRONT VIEW

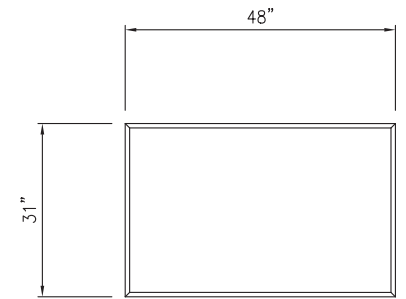

TOP VIEW



NLCB53

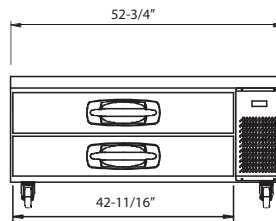

FRONT VIEW

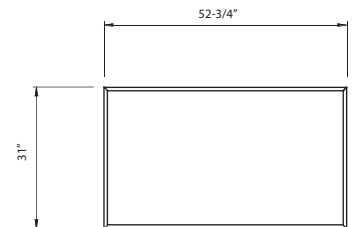

TOP VIEW



NLCB60

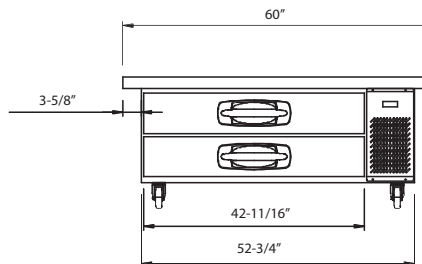

FRONT VIEW

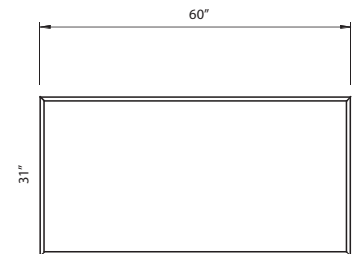

TOP VIEW



NLCB72

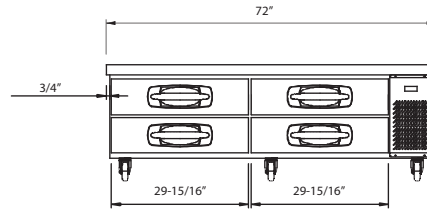

FRONT VIEW

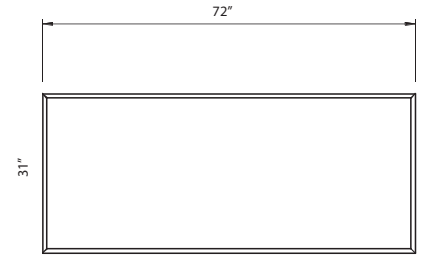

TOP VIEW



NLCB84

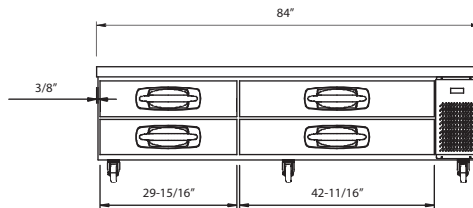

FRONT VIEW

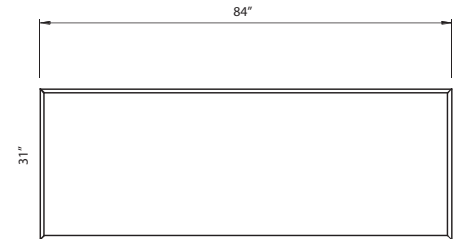

TOP VIEW



NLCB96

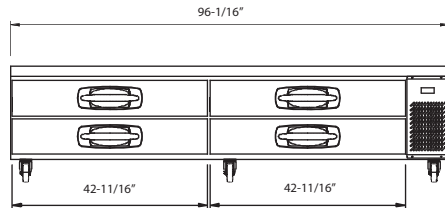

FRONT VIEW

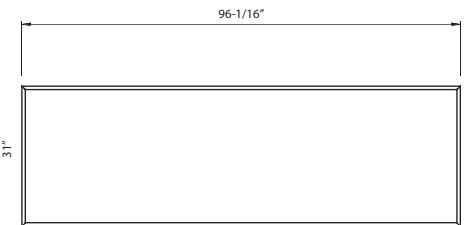

TOP VIEW

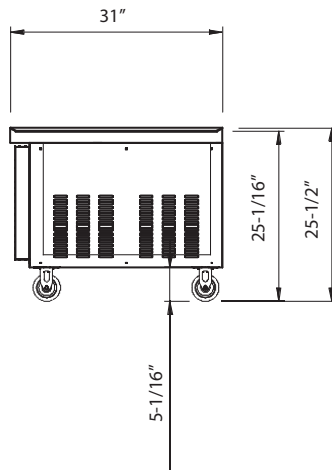

SIDE VIEW



NOR-LAKE, INCORPORATED
 Revision Date: 05/15
 © 2015 NOR-LAKE, INC.
 Printed in the U.S.A.
 Part Number: 143582

