

REFRIGERATOR MANUFACTURER
Turbo air
 more durable, efficient, beautiful

4184 E. Conant St.
 Long Beach, CA 90808
 Tel. 310-900-1000
 Fax. 310-900-1077
www.turboairinc.com

Project:	
Model #:	
Item #:	
Available W/H:	Qty:
Approval:	
AIA #:	SIS #:
CSI Section 11400	

Beer Dispensers

*Underbar Equipment
 Super Deluxe Series*

Patented Self-Cleaning Condenser

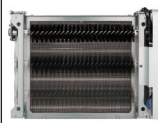

This product is equipped with a fine mesh filter to the front of the condenser to catch dust, and a rotating brush that moves up and down daily to remove excess buildup outward and away.

**Model : TBD-4SDD-N
 TBD-4SBD-N**



TBD-4SDD-N



TBD-4SBD-N

- Does not include keg couplers

≡ FEATURES & BENEFITS ≡

■ Self-Cleaning Condenser

The accumulation of dust in the condenser can cause the failure or breakdown of refrigerators. Refrigerators run normally until they reach a certain level of accumulation. At some point, when they are over the limit, their performance drops quickly resulting in damage to, or disposal of the stored products inside. The Self-Cleaning Condenser device keeps the condenser clean and prevents system failure by automatically brushing daily.

■ Hydrocarbon refrigerants (R-290)

With innovative and eco-friendly technology, Turbo Air brings you hydrocarbon refrigerators designed to meet DOE's Energy Conservation Standards in 2017 and to use EPA's SNAP Program approved HC refrigerants. Hydrocarbon refrigerants do not deplete the ozone layer and have very low contribution to global warming (ODP-0, GWP-3).

■ Stainless steel cabinet construction

Super Deluxe (SDD) models boast a stainless steel exterior (except galvanized steel back and bottom). SBD models have an attractive wear-resistant black vinyl exterior. Heavy gauge stainless steel countertop is perfect for sanitation and durability. The interior is stainless steel except galvanized steel top. Spacious inside construction with 32" inner height accommodates various sizes of beer kegs. Turbo Air beer dispenser model guarantees the utmost in cleanliness and long product life. It also adds a touch of style to the most refined setting.

■ Digital Temperature Controller

External digital temperature control has an easily accessible panel to quickly adjust temperatures, which includes a defrost control.

■ Forced air cooling system

Fast cooling and balanced temperature throughout the cabinet.

■ Ergonomically designed doors

Customers' fatigue fades away with easy grip handles and doors that open effortlessly. These features along with self-closing doors make this the ultimate choice in customer convenience.

■ Side mount compressor unit

With compressors positioned on the side of the unit, our refrigerators can now be serviced without being moved. Our innovative, front breathing feature also allows this model to be highly efficient in narrow spaces.

■ High-density polyurethane insulation

The entire cabinet structure is foamed-in-place using high density, HCFC free polyurethane insulation.

■ 3" diameter stainless steel insulated beer tower

■ Comes standard with a four-way tapper manifold

■ Beer dispenser holds 33°F ~ 38°F for the best in beverage preservation



Model	Swing Doors	1/2 Barrels	HP	AMPS	Crated Weight (lbs.)	L x D' x H† (inches)
TBD-4SDD-N	4	2	1/3	2.7	443	903/8 x 271/4 x 371/8
TBD-4SBD-N	4	2	1/3	2.7	443	903/8 x 271/4 x 371/8

Model : TBD-4SDD-N, TBD-4SBD-N

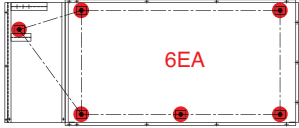
ELECTRICAL DATA		
Voltage	115/60/1	
Plug Type	Ⓜ NEMA 5-15P	
Full Load Amperes	2.7	
Compressor HP	1/3	
Refrigerant	R-290	
Cord Length (ft.)	8.5	
DIMENSIONAL DATA		
Net Capacity	1/2 Barrels	2
	cu. ft.	36.47
Ext. Length Overall (in.)	90 1/4 (2294mm)	
Ext. Depth Overall (in.)*	27 1/4 (692mm)	
Ext. Height Overall (in.)†	37 1/8 (943mm)	
# of Swing Doors	4	
# of Casters	 6EA	
Net Weight (lbs.)	420	
Gross Weight (lbs.)	443	

Design and specifications subject to change without notice.

Actual shipping weight may differ due to extra packing materials for product protection.

* Depth does not include 3/8" for door handles. Depth does not include 1-1/4" for rear spacers.

† Height does not include 4-7/8" for caster height. Height does not include 16" for draft arm.

■ **WARRANTY : 3 Year Parts and Labor Warranty**
Additional 4 Year Warranty on Compressor

■ **STANDARD FEATURES**

- *Anti-corrosion coated evaporator*
- *Double faucet beer tower standard*
- *Door locks standard*
- *Self-contained system*
- *4" dia. swivel casters with locks on the front set*

■ **OPTIONAL ACCESSORIES**

- 1" caster, 1/2" diameter & 13 TPI: S28R813660 (non-brake)
- 2" caster for underbar series, 1/2" diameter: P0165B0100 (non-brake), P0165B0110 (w/ brake)
- 2.5" caster: 30265H0100 (non-brake), 30265H0200 (w/ brake)
- 5" caster, 1/2" diameter & 13 TPI: M726500100 (non-brake), M726500200 (w/ brake)
- Leveling leg, 1/2" - 13 TPI x 1.54": LFM1213566
- 6" adjustable stainless steel leg: P0121P0100
- Triple faucet draft tower: 153A-3

PLAN VIEW

(unit : inch)

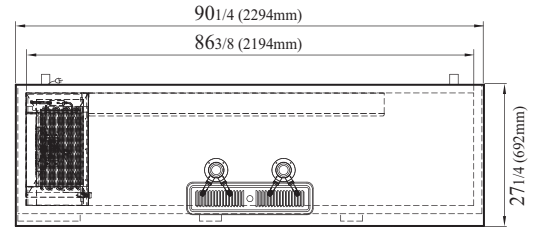

TOP VIEW

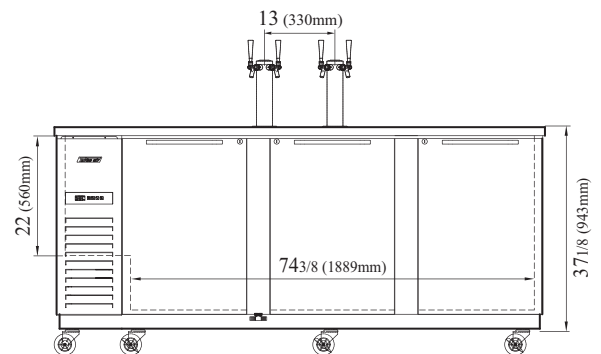

FRONT VIEW

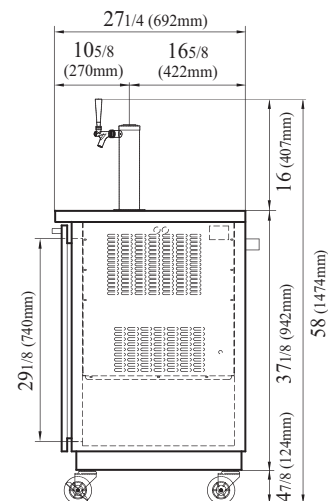

SIDE VIEW

Ver.20210318

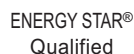

- Turbo Air : 800-627-0032
- GK : 800-500-3519
- Warranty : 800-381-7770
- AC : 888-900-1002

