

REFRIGERATOR MANUFACTURER
Turbo air
 more durable, efficient, beautiful

4184 E. Conant St.
 Long Beach, CA 90808
 Tel. 310-900-1000
 Fax. 310-900-1077
www.turboairinc.com

Project:	
Model #:	
Item #:	
Available W/H:	Qty:
Approval:	
AIA #:	SIS #:
CSI Section 11400	

Club Top Beer Dispensers

*Underbar Equipment
 Super Deluxe Series*

Patented Self-Cleaning Condenser

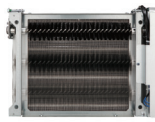

This product is equipped with a fine mesh filter to the front of the condenser to catch dust, and a rotating brush that moves up and down daily to remove excess buildup outward and away.

**Model : TCB-4SDD-N
 TCB-4SBD-N**



- Does not include
 keg couplers

TCB-4SDD-N

TCB-4SBD-N

≡ FEATURES & BENEFITS ≡

- Self-Cleaning Condenser**
 The accumulation of dust in the condenser can cause the failure or breakdown of refrigerators. Refrigerators run normally until they reach a certain level of accumulation. At some point, when they are over the limit, their performance drops quickly resulting in damage to, or disposal of the stored products inside. The Self-Cleaning Condenser device keeps the condenser clean and prevents system failure by automatically brushing daily.
- Hydrocarbon refrigerants (R-290)**
 With innovative and eco-friendly technology, Turbo Air brings you hydrocarbon refrigerators designed to meet the new standards of the EPA and DOE in 2017. Hydrocarbon refrigerants do not deplete the ozone layer and have very low contribution to global warming (ODP-0, GWP-3).
- Forced air cooling system**
 Fast cooling and balanced temperature throughout the cabinet.
- Stainless steel cabinet construction**
 Super Deluxe (SDD) models boast a stainless steel exterior (except galvanized steel back and bottom). SBD models have an attractive wear-resistant black vinyl exterior. Heavy gauge stainless steel countertop and club top lids are perfect for sanitation and durability. The interior is stainless steel except galvanized steel top. Spacious inside construction with 32" inner height accommodates various sizes of beer kegs. Turbo Air Club Top model guarantees the utmost in cleanliness and long product life. It also adds a touch of style to the most refined setting.
- Easy to glide stainless steel club top lids**
- 3" diameter stainless steel insulated beer towers**
- Digital Temperature Controller**
 External digital temperature control has an easily accessible panel to quickly adjust temperatures, which includes a defrost control.
- High-density polyurethane insulation**
 The entire cabinet structure is foamed-in-place using high density, HCFC free polyurethane insulation.
- Comes standard with a four-way tapper manifold**
- Club top (TCB) models provide easy access to the interior area**
 Club Top is a combined functional cabinet of direct draw cold beer dispenser and glass chiller. This convenient model provides easy access to interior storage area of the refrigerator for chilled beer glasses.
- Ergonomically designed doors**
 Customers' fatigue fades away with easy grip handles and doors that open effortlessly. These features along with self-closing doors make this the ultimate choice in customer convenience.
- Side mount compressor unit**
 With compressors positioned on the side of the unit, our refrigerators can now be serviced without being moved. Our innovative, front breathing feature also allows this model to be highly efficient in narrow spaces.
- Club top beer dispenser holds 33°F ~ 38°F for optimal beverage preservation**





Model	Swing Doors	1/2 Barrels	HP	AMPS	Crated Weight (lbs.)	L x D x H† (inches)
TCB-4SDD-N	3	4	1/3	2.6	448	903/8 x 271/4 x 385/8
TCB-4SBD-N	3	4	1/3	2.6	448	903/8 x 271/4 x 385/8

Club Top Beer Dispenser

Underbar Equipment
Super Deluxe Series

Model : TCB-4SDD-N, TCB-4SBD-N

ELECTRICAL DATA		
Voltage	115/60/1	
Plug Type	 NEMA 5-15P	
Full Load Amperes	2.6	
Compressor HP	1/3	
Refrigerant	R-290	
Cord Length (ft.)	8.5	
DIMENSIONAL DATA		
Net Capacity	1/2 Barrels	4
	cu. ft.	36.47
Ext. Length Overall (in.)	90 ³ / ₈ (2294mm)	
Ext. Depth Overall (in.)*	27 ¹ / ₄ (692mm)	
Ext. Height Overall (in.)†	38 ⁵ / ₈ (980mm)	
# of Swing Doors	3	
# of Casters	 6EA	
Net Weight (lbs.)	425	
Gross Weight (lbs.)	448	

Design and specifications subject to change without notice.

Actual shipping weight may differ due to extra packing materials for product protection.

* Depth does not include 3/8" for door handles. Depth does not include 1-1/4" for rear spacers.

† Height does not include 4-7/8" for caster height. Height does not include 14-1/2" for draft arm.

■ **WARRANTY : 3 Year Parts and Labor Warranty**
Additional 4 Year Warranty on Compressor

■ STANDARD FEATURES

- Anti-corrosion coated evaporator
- Double faucet beer tower standard
- Door locks standard
- Self-contained system
- 4" dia. swivel casters with locks on the front set

■ OPTIONAL ACCESSORIES

- 1" caster, 1/2" diameter & 13 TPI: S28R813660 (non-brake)
- 2" caster for underbar series, 1/2" diameter: P0165B0100 (non-brake), P0165B0110 (w/ brake)
- 2.5" caster: 30265H0100 (non-brake), 30265H0200 (w/ brake)
- 5" caster, 1/2" diameter & 13 TPI: M726500100 (non-brake), M726500200 (w/ brake)
- Leveling leg, 1/2" - 13 TPI x 1.54": LFM1213566
- 6" adjustable stainless steel leg: P0121P0100
- Triple faucet draft tower: 153A-3

Ver.20210318

PLAN VIEW

(unit : inch)

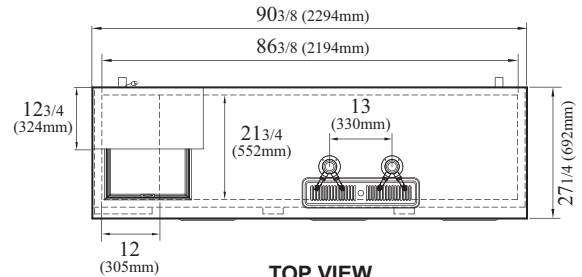

TOP VIEW

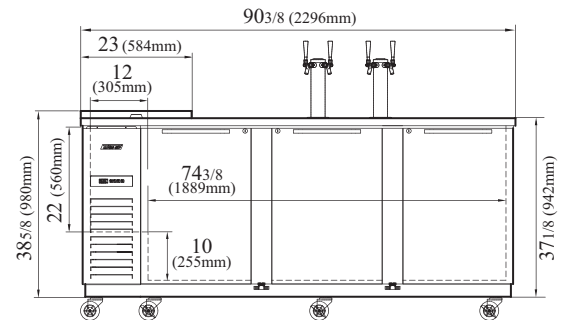

FRONT VIEW

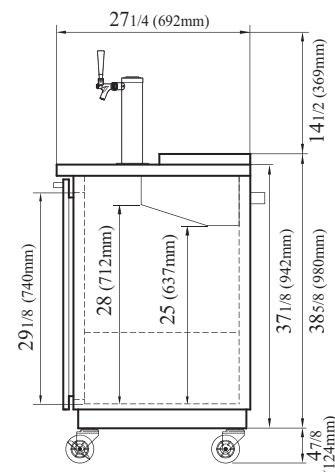

SIDE VIEW

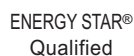

- Turbo Air : 800-627-0032
- GK : 800-500-3519
- Warranty : 800-381-7770
- AC : 888-900-1002



Continued product development may necessitate specification changes without notice.