

REFRIGERATOR MANUFACTURER
Turbo air
 more durable, efficient, beautiful

4184 E. Conant St.
 Long Beach, CA 90808
 Tel. 310-900-1000
 Fax. 310-900-1077
www.turboairinc.com

Project :	
Model # :	
Item # :	Qty :
Available W/H :	
Approval :	

Pizza Prep Table - Drawers

Food Prep Tables - Pizza Prep
 Super Deluxe Series

Model : TPR-93SD-D4-N

Patented Self-Cleaning Condenser

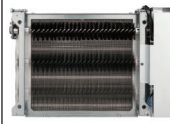

This product is equipped with a fine mesh filter to the front of the condenser to catch dust, and a rotating brush that moves up and down daily to remove excess buildup outward and away.



- Each drawer accommodates up to 6" deep sixth (1/6) size pans (drawer pans not included)

≡ FEATURES & BENEFITS ≡

Self-Cleaning Condenser

The accumulation of dust in the condenser can cause the failure or breakdown of refrigerators. Refrigerators run normally until they reach a certain level of accumulation. At some point, when they are over the limit, their performance drops quickly resulting in damage to, or disposal of the stored products inside. The Self-Cleaning Condenser device keeps the condenser clean and prevents system failure by automatically brushing daily.

Hydrocarbon refrigerants (R-290)

With innovative and eco-friendly technology, Turbo Air brings you hydrocarbon refrigerators designed to meet DOE's Energy Conservation Standards in 2017 and to use EPA's SNAP Program approved HC refrigerants. Hydrocarbon refrigerants do not deplete the ozone layer and have very low contribution to global warming (ODP-0, GWP-3).

Cold Bunker system

Our innovative forced air system allows cold air to flow all around the food pan area, covering not only underneath the pan, but also the front, top and the rear. This unique air flow creates a cold air-shield around the pan, which maintains the food temperature at under 41°F (NSF requirement) even when the lids are opened. In addition, the compartment isolates pans from the reach-in area to prevent food spillage.

Refrigerator holds 33°F ~ 41°F for the best in food preservation

Sturdy, clean stainless steel shelving & drawers

Shelves are the most important part of cleanliness as they come in direct contact with food. After a while, PVC coated wire shelves may peel, rust and lead to unsanitary conditions. Only the Turbo Air Super Deluxe series uniquely provides stainless steel shelving.

Stainless steel cabinet construction

The Turbo Air Super Deluxe model boasts a stainless steel interior (ABS door liner) and exterior (galvanized steel back & bottom) including durable stainless steel drawers. It guarantees the utmost in cleanliness and long product life. The Super Deluxe adds a touch of style to the most refined setting.

Extra deep HDPE cutting board

Our cutting board is 19-1/4" deep and 1/2" thick to provide ample working space, and is made of easy to use and sanitize HDPE (High Density Polyethylene). The new side rail cutting board bracket makes it easy to secure and remove the cutting board.

Insulated pan cover

Front breathing, side mount compressor unit

With compressors positioned on the side of the unit, our refrigerators can now be serviced without being moved. Our innovative, front breathing feature also allows this model to be highly efficient in narrow spaces.



Model	Swing Door	Drawers	CU./FT.	#of Shelves	#of Pans	HP	AMPS	Crated Weight (lbs.)	L x D x H† (inches)
TPR-93SD-D4-N	1	4	31	2	12	2/3	5.6	722	93 3/8 x 32 1/4 x 36

Model : TPR-93SD-D4-N

ELECTRICAL DATA	
Voltage	115/60/1
Plug Type	Ⓜ NEMA 5-15P
Full Load Amperes	5.6
Compressor HP	2/3
Cord Length (ft.)	9
Refrigerant	R-290
DIMENSIONAL DATA	
Ext. Length Overall (in.)	93 ³ / ₈ (2378mm)
Ext. Depth Overall (in.)*	32 ¹ / ₄ (819mm)
Ext. Height Overall (in.)†	36 (914mm)
# of Doors	1
# of Shelves	2
# of Pans	12
Net Capacity (cu. ft.)	31
Net Weight (lbs.)	612
Gross Weight (lbs.)	722

Design and specifications subject to change without notice.

Actual shipping weight may differ due to extra packing materials for product protection.

* Depth does not include 3" for cutting boards and 1" for rear spacers.

† Height does not include 5" for caster height.

■ **WARRANTY : 3 Year Parts and Labor Warranty**
Additional 2 Year Warranty on Compressor

■ **STANDARD FEATURES**

- Anti-corrosion coated evaporator
- Self-contained system
- Standard 4" dia. swivel casters with locks on the front set
- Standard 1/3 size, 4" deep condiment pans included

■ **OPTIONAL ACCESSORIES :**

- 2.5" caster, 1/2" diameter & 13 TPI: 30265H0100 (non-brake), 30265H0200 (w/ brake)
- 5" caster, 1/2" diameter & 13 TPI: M726500100 (non-brake), M726500200 (w/ brake)
- 6" ABS plastic leg: 30221M0200
- 6" stainless steel leg: 30221M0600

PLAN VIEW

(unit : inch)

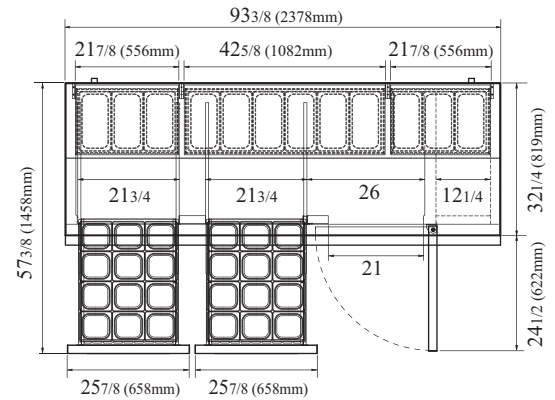

PLAN VIEW

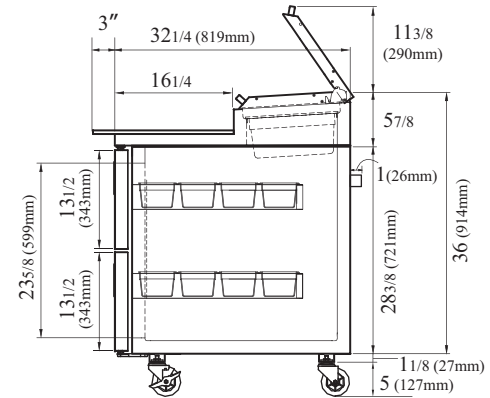

SIDE VIEW

Ver.20181211



- Turbo Air : 800-627-0032
- GK : 800-500-3519
- Warranty : 800-381-7770
- AC : 888-900-1002

