

Product Specifications Freezer Chef Bases

CFB536: 36" Freezer Chef Base
CFB548: 48" Freezer Chef Base

CFB560: 60" Freezer Chef Base
CFB572: 72" Freezer Chef Base



CFB536



CFB548



CFB560



CFB572

Features and Specifications

CFB536 capacity: 2 drawers holds (2) standard size GN1/1 (12"x20"x4") pans (not included)
CFB548 capacity: 2 drawers holds (4) standard size GN1/1 (12"x20"x4") pans (not included)
CFB560 capacity: 2 drawers holds (4) standard size GN1/1 (12"x20"x4") pans (not included)
CFB572 capacity: 4 drawers holds (8) standard size GN1/1 (12"x20"x4") pans (not included)
AISI 304 stainless steel interior and exterior
Temperature range: -13°F to 14°F
Electronic digital temperature control with alarms
Autodefrost
High efficiency compressor, side mount (CFB536, CFB548, CFB560: 7.3 running amps) (CFB572: 8.7 running amps)
High efficiency evaporator coil & condenser
Self-lubricating, sealed cast iron evaporator fan motor with high volume airflow design
CFC-free high-density polyurethane insulated cabinet
Factory pre-wired for dedicated outlet, 11 ft cord and plug included NEMA 5-15P
Environmentally friendly R449a refrigerant - 16 oz (0.450 kg)
CFB536 dimensions: 26" H x 36" W x 32 1/2" D
CFB548 dimensions: 26" H x 48" W x 32 1/2" D
CFB560 dimensions: 26" H x 60" W x 32 1/2" D
CFB572 dimensions: 26" H x 72" W x 32 1/2" D

Model Details

Model	Description	Voltage/Hz/Phase	Shipping Weight
UCFB536-SS61A	36" Freezer Chef Base	115v / 60hz / 1	340 lb
UCFB548-SS61A	48" Freezer Chef Base	115v / 60hz / 1	410 lb
UCFB560-SS61A	60" Freezer Chef Base	115v / 60hz / 1	549 lb
UCFB572-SS61A	72" Freezer Chef Base	115v / 60hz / 1	653 lb



Product Specifications • Freezer Chef Bases

Front (CFB536)

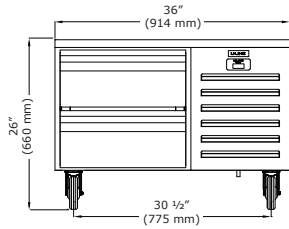

Side

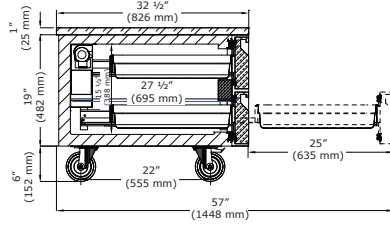

Top

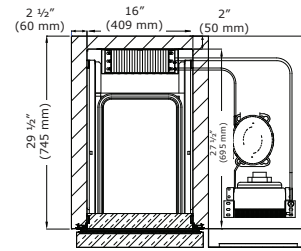

Front (CFB548)

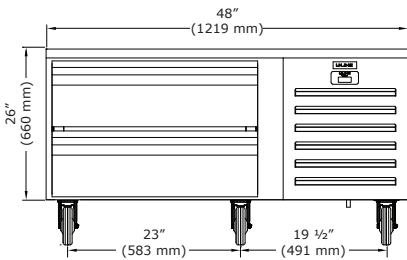

Side

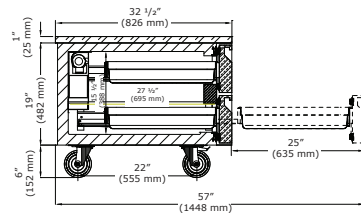

Top

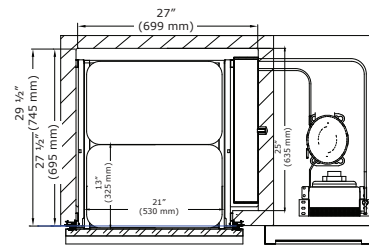

Front (CFB560)

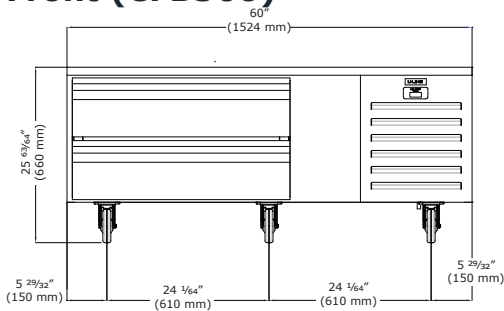

Side

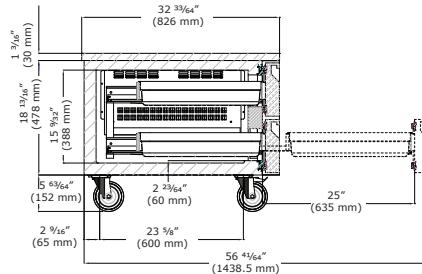

Top

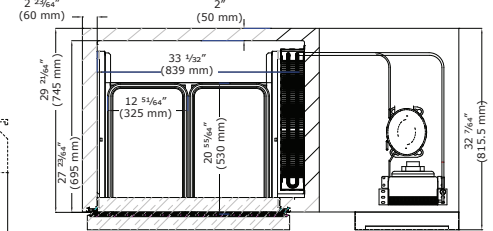

Front (CFB572)

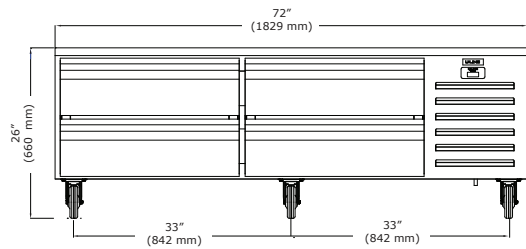

Side

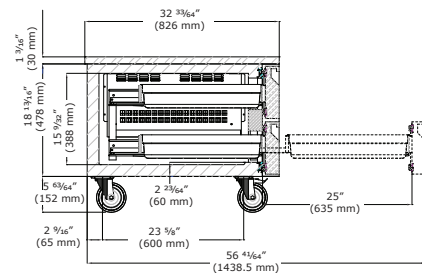

Top

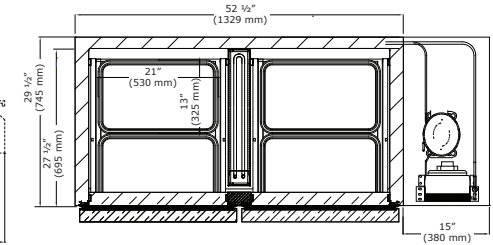

Commercial Warranty

1 Year (parts & labor) / 5 year sealed system (parts)
See complete warranty for details

