



UCG130A

## Features and Benefits

- Produces clear, long-lasting gourmet cubes.
- Space-saving 18 1/4 in. (463 mm) wide under-counter design.
- Produces up to 126 lbs. (57 kg) of ice per day.
- Constructed from sturdy, corrosion-resistant stainless steel and fingerprint-proof plastic.
- Ideal for any under-counter or bar application.
- Contemporary, elegant design.
- Environmentally friendly R290A refrigerant.

## Space-Saving Solutions

- Front air discharge design for compact spaces.
- Low profile top saves counter space.
- Stores up to 48 1/2 lbs. (22 kg) of ice.
- Easy front access to ice.
- Removable Air Filter.

UCG130A GOURMET SERIES UNDERCOUNTER

## Options & Accessories

Ice Machine Model	WATER FILTERS		
	Manifold		Inline
	System	Replacement	System
UCG130A	IFQ-1S	IOMQ-S	IF14C / IF18C

## Ice Form

GOURMET	
Height	1 1/4" (30.5mm)
Diameter	1 1/4" (34.5mm)

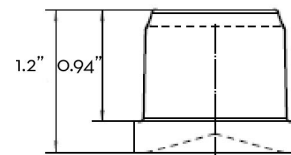
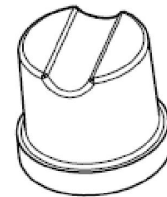
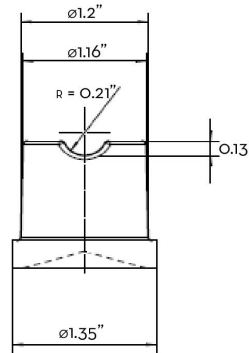
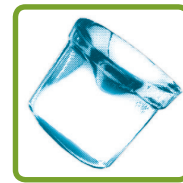

## Ice Maker Warranty

Every UCG Ice-O-Matic ice maker is backed by a warranty that provides both parts and labor coverage.

- Three years parts and labor.

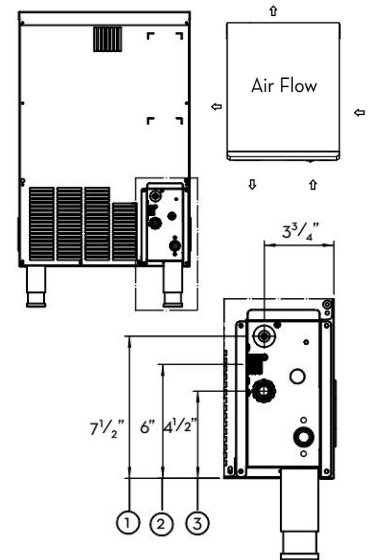
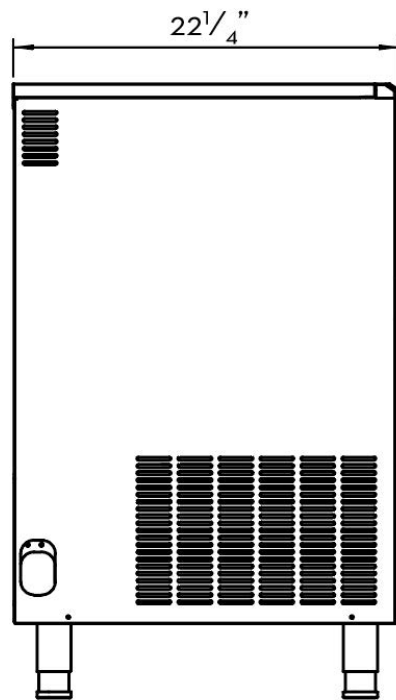
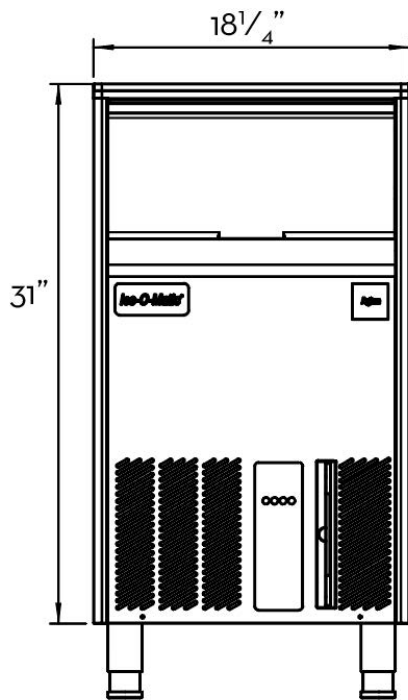

- 1 - Power Cord
- 2 - 3/4" Water Inlet
- 3 - 25/32" Water Drain

## Operating Requirements

	MINIMUM	MAXIMUM
	<b>60 Hz</b>	
Ambient Temp. Range Air	50°F(10°C)	109°F(43°C)
Water Temp.	41°F(5°C)	100°F(38°C)
Water Pressure	14psi(1 Bar)	70psi(5 Bar)
Electrical Voltage	115V/60Hz/1ph	

## Dimensions

ALL MODELS	
W x D x H (mm)	463 x 566 x 789
W x D x H (in.)	18 1/4 x 22 1/4 x 31

\*Dimensions do not account for the included adjustable legs.

## Specifications

Model Number	Cond. Unit	Ice Production per 24 hrs (kg)/(lbs)	Storage Capacity (kg)/(lbs)	Water Consumption (gph)	kWH Used per 100 lbs of ice @ 90°F air/70°F water	Voltage Characteristics
UCG130A	Air	57/126	22/48.5	1.35 gph	9	115/60/1

NOTES:  
 Approx. Shipping Weight lbs(kg): 99(44)  
 Refrigerant Type: R290A  
 All specifications and performance data are subject to normal manufacturing variances.