

HOLDING & TRANSPORT**VULCAN****VBP SERIES
HOLDING & TRANSPORT CABINETS**

Model VBP15I



(except VBP5I)



UL listed. UL listed to Canadian safety standards.
Classified by UL to NSF Std. #4.

SPECIFICATIONS

Vulcan Hart Model No. VBP heated holding and transport cabinets. Blower motor for gentle and even temperature distribution. Complete with 5" heavy duty casters (2 swivel with brakes and 2 rigid) (VBP5I has 3" casters). Recessed control panel containing heating indicator light, analog thermometer, and full range thermostat for temperatures up to 190°F (88°C). Cabinet will hold 18" x 26" sheet pans, 12" x 20" steam table pans, or a combination of both on 1½" centers. Complete with universal tray slides adjustable on 1½" centers. Cabinet interior and exterior are both constructed out of 20 gauge stainless steel. Recessed side-mounted handles, magnetic action door latch, and full insulation; 1½" in side walls and 2" in top. Integrated steel frame for maximum strength. Field reversible doors. Complete with top mounted cord and plug: NEMA 5-15 for 120 volts and NEMA 6-15 for 208-240 volts. Lifetime warranty on heating elements.

- VBP5I** Holding & Transport Cabinet
- VBP7I** Holding & Transport Cabinet
- VBP13I** Holding & Transport Cabinet
- VBP15I** Holding & Transport Cabinet
- VBP77I** Holding & Transport Cabinet

STANDARD FEATURES

- Holding Capacity:
 - 18" x 26" sheet pans
 - 12" x 20" pans, or a combination of both on 1½" centers
- Blower motor for gentle and even temperature distribution
- Dutch doors (VBP15I only)
- 5" heavy duty casters (2 swivel with brakes and 2 rigid) (3" on VBP5I)
- Recessed side mounted handles
- Recessed control panel
- Heating indicator light
- Analog thermometer
- Full range thermostat for temperatures up to 190°F (88°C)
- Universal tray slides adjustable on 1½" centers. VBP15I, VBP13I & VBP77I ship with 10 pairs of tray slides. VBP7I & VBP5I ship with 5 pairs.
- Interior and the exterior are both constructed out of 20 gauge stainless steel
- Fully insulated with 1½" in side walls and 2" in top
- Integrated steel frame for maximum strength
- Magnetic action door latch
- Field reversible doors
- Top mounted cord
- Complete with cord and plug: NEMA 5-15 for 120 volts and NEMA 6-15 for 208-240 volts
- Lifetime warranty on the heating elements

OPTIONS

- 208/240 volt
- Humidity pan
- Full perimeter bumper
- Glass Dutch doors
- VRH oven racking available for VBP7I, VBP77I, and VBP15I
- Wire shelves to sit on tray slides
- Electronic control with digital display (120V only)
- Transport latch
- Additional tray slides

VULCAN

a division of ITW Food Equipment Group LLC

P.O. Box 696 ■ Louisville, KY 40201 ■ Toll-free: 1-800-814-2028 ■ Local: 502-778-2791 ■ Quote & Order Fax: 1-800-444-0602



VBP SERIES
HOLDING & TRANSPORT CABINETS

Drawings shown with optional bumper

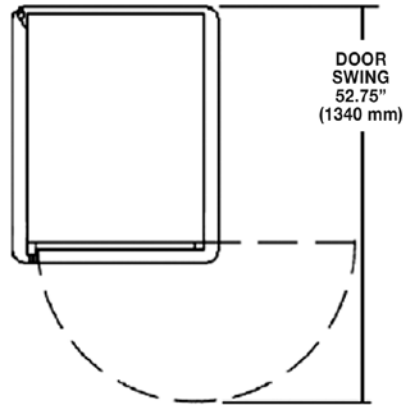

All Models Top View

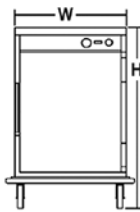

VBP51 Front & Side Views

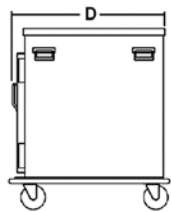

VBP71 Front & Side Views

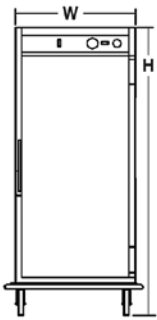
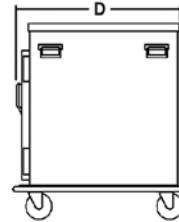

VBP131 Front & Side Views

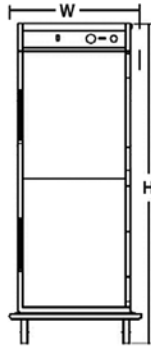
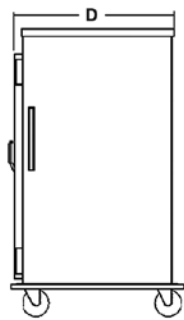

VBP151 Front & Side Views

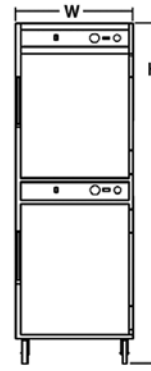
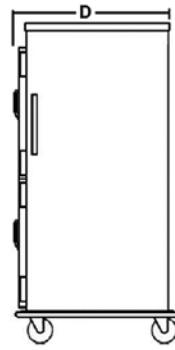

VBP77 Front & Side Views

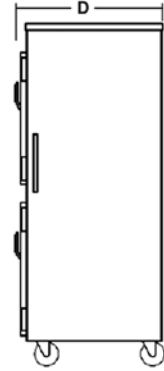

MODEL	DIMENSIONS	CAPACITY		ELECTRICAL			SHIPPING WEIGHTS	
	EXTERIOR	12" x 20" x 2 1/2" PANS	18" x 26" SHEET PANS	VOLTS	WATTS	AMPS	LBS	KG
VBP51	25" W x 33" D x 30 1/2" H	10	5	120	1,000	8.3	173	79
VBP71	25" W x 33" D x 39" H	14	7	120	1,000	8.3	198	90
VBP131	25" W x 33" D x 60" H	26	13	120	1,200	10	270	123
VBP151	25" W x 33" D x 65 1/4" H	30	15	120	1,200	10	297	135
VBP77	25" W x 33" D x 72" H	28	14	120	1,000*	8.3*	342	155

*per compartment

Optional bumper adds 3/4" to the width and 1/8" to the depth.



a division of ITW Food Equipment Group LLC

P.O. Box 696 ■ Louisville, KY 40201 ■ Toll-free: 1-800-814-2028 ■ Local: 502-778-2791 ■ Quote & Order Fax: 1-800-444-0602