

FD-1001M_H-C

MODULAR CUBELET ICE MACHINE

SLIM-LINE DISPENSER SERIES

Item # _____

Project: _____

Qty: _____

*AutoCad available on KCL

FD-1001M_H-C

6/11

Item # 13242

CUBELET DIMENSIONS

W x D x H

FD-1001M_H-C
22 x 24 x 26





FD-1001MAH-C

Air-Cooled

Shown on an optional
Lancer 22" Dispenser

FD-1001MRH-C

Remote Air-Cooled

- Up to 940 lbs. of ice production per 24 hours
- Durable stainless steel exterior
- Protected by *H-GUARD Plus* Antimicrobial Agent 
- Advanced CleanCycle I2® Design 
- Flushes every 2 hours to remove sediment and improve efficiency
- Produces ideal chewable ice
- Dispenser ready / infrared bin control
- R-404A Refrigerant



ISO9001-15014E01

Warranty

Valid in United States, Canada, Puerto Rico, & U.S. Territories. Contact factory for warranty in other countries.

Three Year - Parts & Labor on entire machine. (Serial numbers Vxxxxx) and after.)

Five Year - Parts on compressor, air-cooled condenser coil.



© HOSHIZAKI AMERICA, INC.

618 Hwy. 74 S., Peachtree City, GA 30269

TEL 1-800-438-6087

FAX 1-800-345-1325

www.hoshizaki.com

A City Discount

FD-100IM_H-C CUBELET ICE MACHINE SLIM-LINE DISPENSER SERIES

DIMENSIONS W x D x H

FD-1001MAH-C
22 x 24 x 26

FD-1001MRH-C
22 x 24 x 26

- Air-cooled
- Remote Air-cooled

AIR-COOLED

Water Temp ° F.	50°	70°	90°
Air Temp ° F.	70°	890	855
	80°	820	790
	90°	725	695

REMOTE AIR-COOLED

Water Temp ° F.	50°	70°	90°
Air Temp ° F.	70°	930	895
	80°	825	790
	90°	730	720

UTILITY CONSUMPTION

Model Number	KWH per 100 LBS. 90/70	Potable Water Gal. per 100 lbs.
FD-1001MAH-C	4.8	12.0
FD-1001MRH-C	4.8	12.0

SPECIFICATIONS

Model Number	Condenser	Amperage	Min. Circuit Ampacity	Shipping Weight
FD-1001MAH-C	Air-Cooled	8.1	15	205 lbs.
FD-1001MRH-C	Remote Air-Cooled	10.2	15	205 lbs.

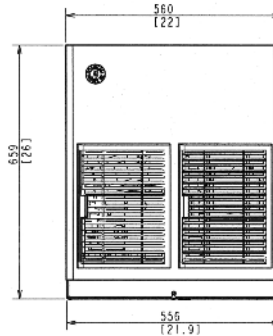

FRONT VIEW

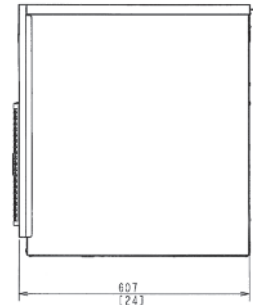

SIDE VIEW

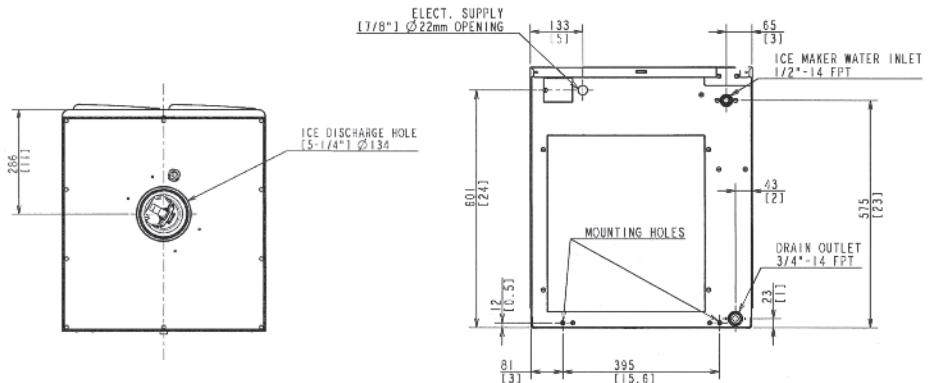

ICE DROP ZONE

AIR-COOLED UNIT

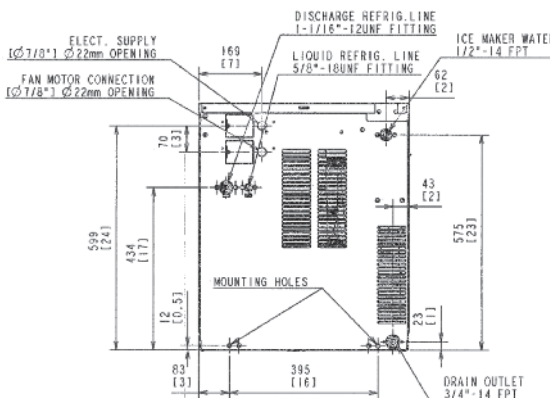

REMOTE AIR-COOLED UNIT

URC-5F Remote Condenser (Sold Separately)

Voltage supply for the URC Remote Condenser is supplied from the Ice Maker. No additional circuit is required.

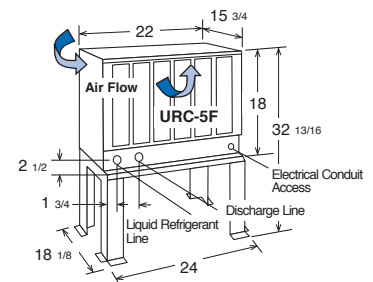

Pre-Charged Tubing Kits

(Sold Separately)
20' R404-2046-2
35' R404-3546-2



ELECTRICAL & PLUMBING/FD-100IM_H-C

- 208-230V/60/1 (3 wire with dedicated neutral for 115V)
- 3/8" OD copper or equivalent independent potable water supply
- 3/4" FPT independent drain connection



© HOSHIZAKI AMERICA, INC.

618 Hwy. 74 S., Peachtree City, GA 30269

OPERATING LIMITS

- Ambient Temp Range 45 - 100°F
- Water Temp Range 45 - 90°F
- Water Pressure 10 - 113psig
- Voltage Range 187 - 253V

SERVICE

- Panels easily removed and all components accessible for service.
- Removable/cleanable air filter. (Air-Cooled model only)

TEL 1-800-438-6087

FAX 1-800-345-1325

www.hoshizaki.com

Printed in U.S.A.

A City Discount

