



Over 90 Years Of Quality Foodservice
Products And Service

Job _____ Item No. _____

Slim Line-Dual Temperature NSF-7 Hot & Refrigerated Cold Pans

HRCP-7200SL HRCP-7300SL HRCP-7400SL

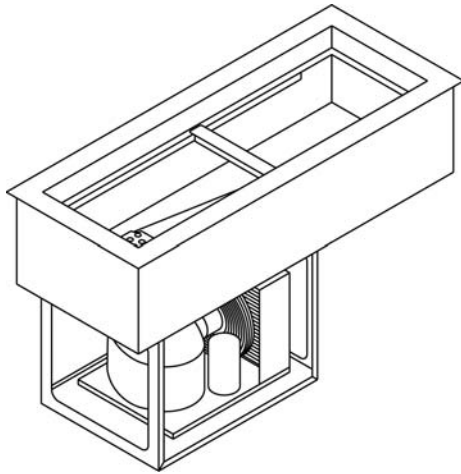

Model HRCP-7200SL

DESCRIPTION

Wells Dual Temperature, Slim Line Hot & Refrigerated Drop-In Cold Pans are two units in one; from a heated Bain Marie to a refrigerated cold pan with the flip of a switch. All models are completely self-contained in two, three and four-well models are CFC free. Pans are recessed 3" to comply with NSF-7 performance requirements. Designed for narrow counters.

SPECIFICATIONS

Exterior – One-piece top flange and coved-corner interiors constructed of 18 gauge stainless steel. Exterior body constructed of heavy gauge, corrosion resistant steel. Condensing unit mounted on corrosion resistant frame below the cold pan.

Interior –CFC free foamed-in-place insulation through-out, 1" drain located in the center for easy cleaning. Ledge is recessed 3" to comply with NSF-7 requirements, allowing a layer of air to insulate food and for pan support.

Refrigeration – Air cooled, 134A and 404A free refrigerant systems featuring wrapped coil construction on both sides and bottom. Refrigeration system features sight glass, easy service valves, dryer/filter and receiver. Condensing unit may be easily removed for service. Larger compressors speed refrigeration process.

Heating - Automatic water-fill with high-limit protection featuring a water sensor and solenoid valve to maintain proper water levels. And efficient electric immersion heating system transfers heat directly to the water while a positive-off thermostat controls provides adjustable and consistent temperatures. Designed for wet operation only.

STANDARD FEATURES

- NSF series 7 compliant
- Slim line drop-in design for narrow counters
- Self contained drop-in design
- Hold standard 12" by 20" food pans and fractional sized pans
- Stainless steel top and liner for maximum strength and durability
- 1" drains for ease of cleaning
- Single control for changing from hot to cold operation.
- Easy access temperature & function control panel attached to a 24" long flexible conduit for optional counter mounting
- Type 134A and 404A CFC free refrigerant
- Fully insulated, CFC free, foamed-in place insulation keeps food cold while saving energy
- Recessed ledge for pan support and colder, fresher products
- Quick & easy service with sight glass, service valves, filter/dryer and receiver
- Adaptor bars provided for food pans
- Limited 1 year parts and labor warranty

OPTIONS & ACCESSORIES

- 5-year compressor warranty
- Perforated bottom strainer plate conveniently holds ice above drain to prevent clogging
- Adaptor bars for fractional sized pans
- Remote on/off switch
- 220/230/240V
- 50 cycle
- Condenser orientation and/or compressor rack location
- Remote models (Includes compressor and condensing units and up to 20' leads)
- Remote models without compressors or condensing units
- 2nd year parts & labor warranty

CERTIFICATIONS



Sheet No. WELLHRCPSL-02/12



Wells Bloomfield • 10 Sunnen Dr. St. Louis, MO 63143 U.S.A.

Phone : (314) 678-6314 • Fax (314) 781-3636

www.wellsbloomfield.com © 2012 Wells Bloomfield • Printed in the U.S.A.

NOTE: Specifications are subject to change without notice and are not intended for installation purposes. See installation instructions prior to installing the unit.



Over 90 Years Of Quality Foodservice Products And Service

Slim Line-Dual Temperature NSF-7 Hot & Refrigerated Cold Pans

□ HRCP-7200SL □ HRCP-7300SL □ HRCP-7400SL

INCHES

MM

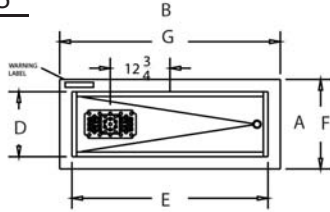

PLAN

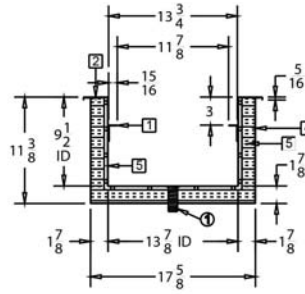

SECTION THRU
SCALE: 1"=1'

General Notes:

- 1 16 GA S/S
- 2 18 GA S/S
- 3 18 GA GALV
- 4 20 GA GALV

HRCP-7200SL Shown

COUNTER CUTOUT:
45 7/8" X 17 7/8"

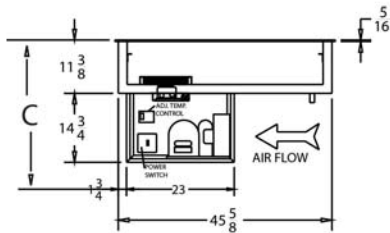

FRONT ELEVATION



SIDE ELEVATION

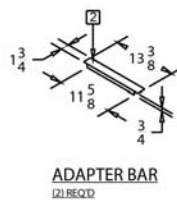

ADAPTER BAR
(2) REQ'D

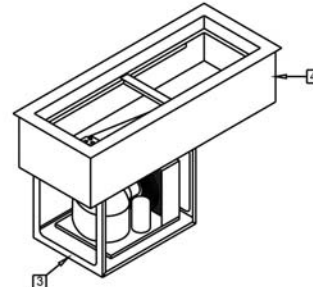
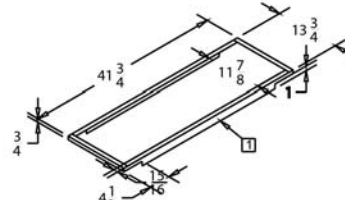

ISOMETRIC

NOTE: Specifications are subject to change without notice and are not intended for installation purposes. See installation instructions prior to installing the unit.

SPECIFICATIONS								SHIPPING INFORMATION							
Model Number	OVERALL DIMENSIONS			INTERIOR DIMENSIONS		CUT OUT DIMENSIONS		Model Number	WEIGHTS		CARTON DIMENSIONS			CRATE SIZE	
	A Front to Back Inches (MM)	B Left to Right Inches (MM)	C Height Inches (MM)	D Front to Back Inches (MM)	E Left to Right Inches (MM)	F Front to Back Inches (MM)	G Left to Right Inches (MM)		SHIPPING WEIGHT POUNDS (KG)	INSTALLED WEIGHT POUNDS (KG)	WIDTH Inches (MM)	DEPTH Inches (MM)	HEIGHT Inches (MM)	CUBIC FEET	CUBIC METERS
HRCP-7200SL	19-1/8 (485)	49 (1245)	26-1/8 (667)	43-3/4 (1112)	13-7/8 (353)	30-3/4 (782)	33 (839)	HRCP-7200SL	220 (100)	190 (87)	29 (737)	34 (864)	32 (813)	18.26	0.52
HRCP-7300SL	19-1/8 (485)	70 (1791)	26-1/8 (667)	65-1/4 (1658)	13-7/8 (353)	43-5/8 (1109)	33 (839)	HRCP-7300SL	240 (109)	210 (96)	29 (737)	48 (1220)	32 (813)	25.78	0.73
HRCP-7400SL	19-1/8 (485)	92 (2337)	26-1/8 (667)	86-3/4 (2204)	13-7/8 (353)	56.5 (1436)	33 (839)	HRCP-7400SL	275 (125)	240 (109)	29 (737)	62 (1575)	32 (813)	33.3	0.94

POWER SUPPLY- HOT OPERATION					
Model Number	VOLTS	WATTS	AMPS	PHASE	POWER SUPPLY
HRCP-7200SL	208/240	1.9/2.5	9.0/10.4	SINGLE	*
HRCP-7300SL	208/240	3.0/4.0	14.4/16.7	SINGLE	*
HRCP-7400SL	208/240	3.8/5.0	18.1/20.8	SINGLE	*

POWER SUPPLY- REFRIGERATION OPERATION						
Model Number	VOLTS	HP	AMPS	PHASE	POWER SUPPLY	REFRIGERANT
HRCP-7200SL	115	1/4	4.9	SINGLE	*	134A
HRCP-7300SL	115	1/3	5.6	SINGLE	*	404A
HRCP-7400SL	115	1/2	6.4	SINGLE	*	404A

* All model permanently field wired connected. Power supply single phase, 3-wire, 120/208-240V, L2-N 120VAC

Due to periodic changes in designs, methods, procedures, policies and regulations, the specifications contained in this sheet are subject to change without notice. While Wells exercises good faith efforts to provide information that is accurate, we are not responsible for errors or omissions in information provided or conclusions reached as a result of using the specifications. By using the information provided, the user assumes all risks in connection with such use.



Wells Bloomfield • 10 Sunnen Dr. St. Louis, MO 63143 U.S.A.
Phone : (314) 678-6314 • Fax (314) 781-3636
www.wellsbloomfield.com © 2012 Wells Bloomfield • Printed in the U.S.A.

NOTE: Specifications are subject to change without notice and are not intended for installation purposes. See installation instructions prior to installing the unit.